

**LMV821 SINGLE, LMV822 DUAL, LMV824 QUAD  
LOW-VOLTAGE RAIL-TO-RAIL OUTPUT OPERATIONAL AMPLIFIERS**

**FEATURES**

- 2.5-V, 2.7-V, and 5-V Performance
- -40°C to 125°C Operation
- No Crossover Distortion
- Low Supply Current at  $V_{CC+} = 5\text{ V}$ :
  - LMV821 0.3 mA Typ
  - LMV822 0.5 mA Typ
  - LMV824 1 mA Typ
- Rail-to-Rail Output Swing
- Gain Bandwidth of 6 MHz Typ at 5 V
- Slew Rate of 1.9 V/ $\mu\text{s}$  Typ at 5 V

**DESCRIPTION**

The LMV821 single, LMV822 dual, and LMV824 quad devices are low-voltage (2.5 V to 5.5 V), low-power commodity operational amplifiers. Electrical characteristics are very similar to the LMV3xx operational amplifiers (low supply current, rail-to-rail outputs, input common-mode range that includes ground). However, the LMV8xx devices offer a higher bandwidth (6 MHz typical) and faster slew rate (1.9 V/ $\mu\text{s}$  typical).

The LMV8xx devices are cost-effective solutions for applications requiring low-voltage/low-power operation and space-saving considerations. The LMV821 is available in the ultra-small DCK package, which is approximately half the size of SOT-23-5. The DCK package saves space on printed circuit boards and enables the design of small portable electronic devices (cordless and cellular phones, laptops, PDAs, PCMCIA). It also allows the designer to place the device closer to the signal source to reduce noise pickup and increase signal integrity.

The LMV8xx devices are characterized for operation from -40°C to 85°C. The LMV8xxI devices are characterized for operation from -40°C to 125°C.

**LMV824 D, DGV, OR PW PACKAGE  
(TOP VIEW)**

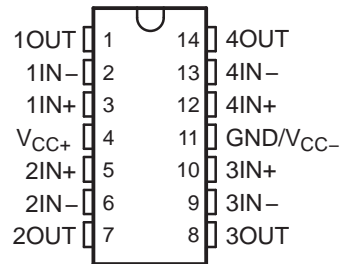

**LMV822 D OR DGK PACKAGE  
(TOP VIEW)**

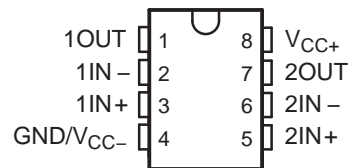

**LMV821 DBV OR DCK PACKAGE  
(TOP VIEW)**

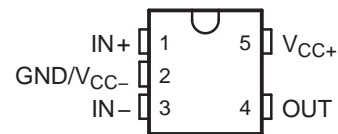

**SYMBOL (EACH AMPLIFIER)**

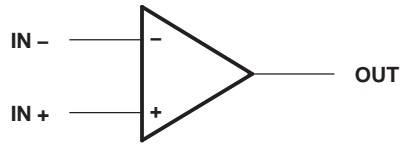

**LMV824 SIMPLIFIED SCHEMATIC**

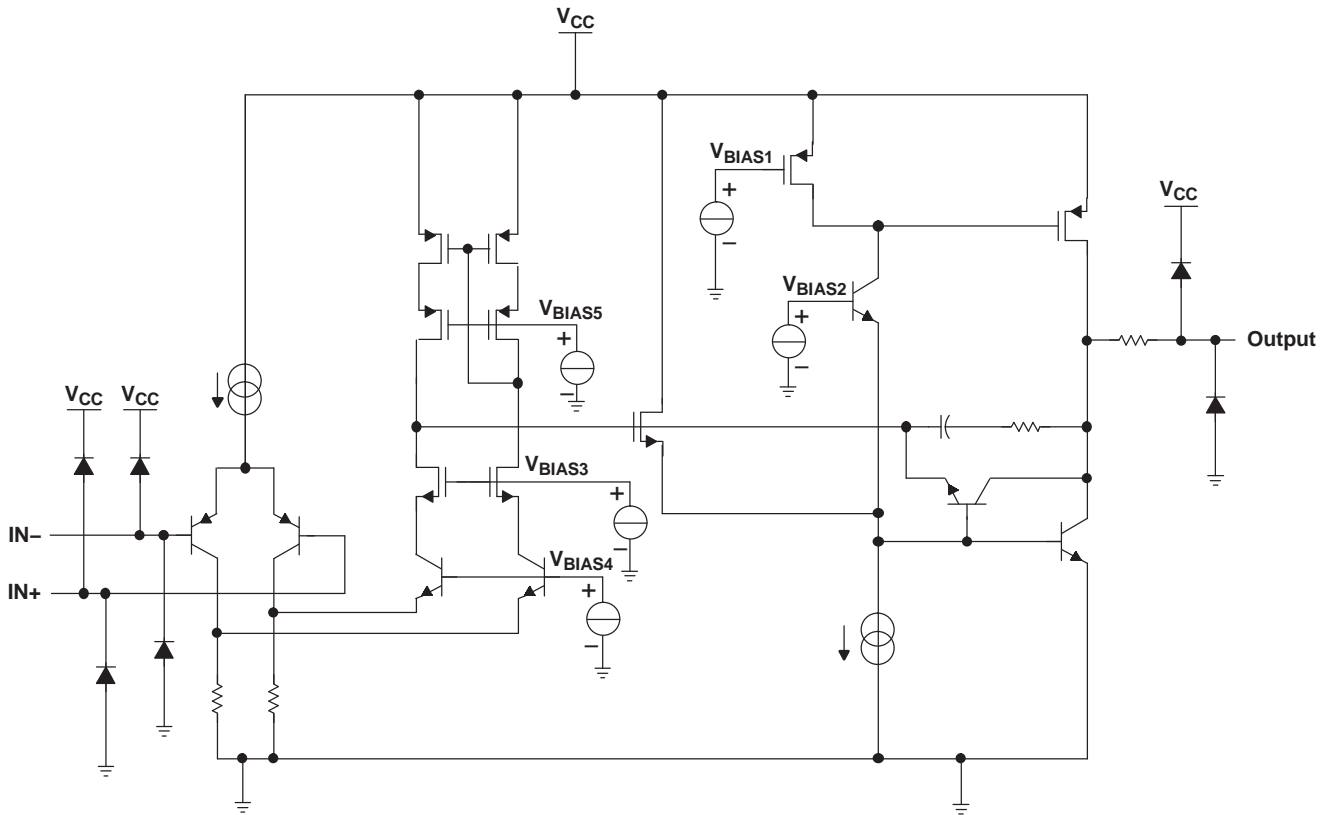

**Absolute Maximum Ratings<sup>(1)</sup>**

over operating free-air temperature range (unless otherwise noted)

		MIN	MAX	UNIT	
$V_{CC}$	Supply voltage <sup>(2)</sup>		5.5	V	
$V_{ID}$	Differential input voltage <sup>(3)</sup>		$\pm V_{CC}$	V	
$V_I$	Input voltage range (either input)	$V_{CC-}$	$V_{CC+}$	V	
	Duration of output short circuit (one amplifier) to ground <sup>(4)</sup>	At or below $T_A = 25^\circ\text{C}$ , $V_{CC} \leq 5.5\text{ V}$		Unlimited	
$\theta_{JA}$	Package thermal impedance <sup>(5)(6)</sup>	D package	8 pin	97	°C/W
			14 pin	86	
		DBV package		206	
		DCK package		252	
		DGK package		172	
		DGV package		127	
PW package		113			
$T_J$	Operating virtual junction temperature		150	°C	
$T_{stg}$	Storage temperature range	-65	150	°C	

- (1) Stresses beyond those listed under “absolute maximum ratings” may cause permanent damage to the device. These are stress ratings only, and functional operation of the device at these or any other conditions beyond those indicated under “recommended operating conditions” is not implied. Exposure to absolute-maximum-rated conditions for extended periods may affect device reliability.
- (2) All voltage values (except differential voltages and  $V_{CC}$  specified for the measurement of  $I_{OS}$ ) are with respect to the network GND.
- (3) Differential voltages are at IN+ with respect to IN-.
- (4) Short circuits from outputs to  $V_{CC}$  can cause excessive heating and eventual destruction.
- (5) Maximum power dissipation is a function of  $T_J(\text{max})$ ,  $\theta_{JA}$ , and  $T_A$ . The maximum allowable power dissipation at any allowable ambient temperature is  $P_D = (T_J(\text{max}) - T_A)/\theta_{JA}$ . Operating at the absolute maximum  $T_J$  of 150°C can affect reliability.
- (6) The package thermal impedance is calculated in accordance with JESD 51-7.

**Recommended Operating Conditions**

		MIN	MAX	UNIT	
$V_{CC}$	Supply voltage (single-supply operation)	2.5	5	V	
$T_A$	Operating free-air temperature	LMV8xxl	-40	125	°C
		LMV8xx	-40	85	

**LMV8xx 2.5-V Electrical Characteristics**
 $V_{CC+} = 2.5\text{ V}$ ,  $V_{CC-} = 0\text{ V}$ ,  $V_{IC} = 1\text{ V}$ ,  $V_O = 1.25\text{ V}$ , and  $R_L > 1\text{ M}\Omega$  (unless otherwise noted)

PARAMETER	TEST CONDITIONS		$T_A$	LMV821/822/824			UNIT
				MIN	TYP	MAX	
$V_{IO}$ Input offset voltage			25°C	1		3.5	mV
			-40°C to 85°C	4			
$V_O$ Output swing	$V_{CC+} = 2.5\text{ V}$ , $R_L = 600\ \Omega$ to 1.25 V	High level	25°C	2.3	2.37	V	
			-40°C to 85°C	2.2			
		Low level	25°C	0.13			0.2
			-40°C to 85°C	0.3			
	$V_{CC+} = 2.5\text{ V}$ , $R_L = 2\text{ k}\Omega$ to 1.25 V	High level	25°C	2.4	2.46		
			-40°C to 85°C	2.3			
		Low level	25°C	0.08			0.12
			-40°C to 85°C	0.2			

**LMV8xxI 2.5-V Electrical Characteristics**
 $V_{CC+} = 2.5\text{ V}$ ,  $V_{CC-} = 0\text{ V}$ ,  $V_{IC} = 1\text{ V}$ ,  $V_O = 1.25\text{ V}$ , and  $R_L > 1\text{ M}\Omega$  (unless otherwise noted)

PARAMETER	TEST CONDITIONS		$T_A$	LMV821/822/824			UNIT
				MIN	TYP	MAX	
$V_{IO}$ Input offset voltage			25°C	1		3.5	mV
			-40°C to 125°C	5.5			
$V_O$ Output swing	$V_{CC+} = 2.5\text{ V}$ , $R_L = 600\ \Omega$ to 1.25 V	High level	25°C	2.28	2.37	V	
			-40°C to 125°C	2.18			
		Low level	25°C	0.13			0.22
			-40°C to 125°C	0.32			
	$V_{CC+} = 2.5\text{ V}$ , $R_L = 2\text{ k}\Omega$ to 1.25 V	High level	25°C	2.38	2.46		
			-40°C to 125°C	2.28			
		Low level	25°C	0.08			0.14
			-40°C to 125°C	0.22			

**LMV8xx 2.7-V Electrical Characteristics**
 $V_{CC+} = 2.7\text{ V}$ ,  $V_{CC-} = 0\text{ V}$ ,  $V_{IC} = 1\text{ V}$ ,  $V_O = 1.35\text{ V}$ , and  $R_L > 1\text{ M}\Omega$  (unless otherwise noted)

PARAMETER	TEST CONDITIONS	$T_A$	LMV821/822/824			UNIT	
			MIN	TYP	MAX		
$V_{IO}$ Input offset voltage		25°C		1	3.5	mV	
		-40°C to 85°C			4		
$\alpha_{VIO}$ Average temperature coefficient of input offset voltage		25°C		1		$\mu\text{V}/^\circ\text{C}$	
$I_{IB}$ Input bias current		25°C		30	90	nA	
		-40°C to 85°C			140		
$I_{IO}$ Input offset current		25°C		0.5	30	nA	
		-40°C to 85°C			50		
CMRR Common-mode rejection ratio	$V_{IC} = 0$ to 1.7 V	25°C	70	85		dB	
		-40°C to 85°C	68				
$+k_{SVR}$ Positive supply-voltage rejection ratio	$V_{CC+} = 1.7\text{ V}$ to 4 V, $V_{CC-} = -1\text{ V}$ , $V_O = 0$ , $V_{IC} = 0$	25°C	75	85		dB	
		-40°C to 85°C	70				
$-k_{SVR}$ Negative supply-voltage rejection ratio	$V_{CC+} = 1.7\text{ V}$ , $V_{CC-} = -1\text{ V}$ to -3.3 V, $V_O = 0$ , $V_{IC} = 0$	25°C	73	85		dB	
		-40°C to 85°C	70				
$V_{ICR}$ Common-mode input voltage range	CMRR $\geq 50$ dB	25°C	-0.2 to 1.9	-0.3 to 2		V	
$A_v$ Large-signal voltage amplification	$R_L = 600\ \Omega$ to 1.35 V, $V_O = 1.35\text{ V}$ to 2.2 V	Sourcing	25°C	90	100	dB	
			-40°C to 85°C	85			
	$R_L = 600\ \Omega$ to 1.35 V, $V_O = 1.35\text{ V}$ to 0.5 V	Sinking	25°C	85	90		
			-40°C to 85°C	80			
	$R_L = 2\text{ k}\Omega$ to 1.35 V, $V_O = 1.35\text{ V}$ to 2.2 V	Sourcing	25°C	95	100		
			-40°C to 85°C	90			
	$R_L = 2\text{ k}\Omega$ to 1.35 V, $V_O = 1.35\text{ V}$ to 0.5 V	Sinking	25°C	90	95		
			-40°C to 85°C	85			
$V_O$ Output swing	$V_{CC+} = 2.7\text{ V}$ , $R_L = 600\ \Omega$ to 1.35 V	High level	25°C	2.5	2.58	V	
			-40°C to 85°C	2.4			
		Low level	25°C		0.13		0.2
			-40°C to 85°C				0.3
	$V_{CC+} = 2.7\text{ V}$ , $R_L = 2\text{ k}\Omega$ to 1.35 V	High level	25°C	2.6	2.66		
			-40°C to 85°C	2.5			
		Low level	25°C		0.08		0.12
			-40°C to 85°C				0.2
$I_O$ Output current	$V_O = 0\text{ V}$	Sourcing	25°C	12	16	mA	
	$V_O = 2.7\text{ V}$	Sinking	25°C	12	26		
$I_{CC}$ Supply current	LMV821		25°C	0.22	0.3	mA	
			-40°C to 85°C		0.5		
	LMV822 (both amplifiers)		25°C	0.45	0.6		
			-40°C to 85°C		0.8		
	LMV824 (all four amplifiers)		25°C	0.72	1		
			-40°C to 85°C		1.2		

**LMV8xx 2.7-V Electrical Characteristics (continued)**
 $V_{CC+} = 2.7\text{ V}$ ,  $V_{CC-} = 0\text{ V}$ ,  $V_{IC} = 1\text{ V}$ ,  $V_O = 1.35\text{ V}$ , and  $R_L > 1\text{ M}\Omega$  (unless otherwise noted)

PARAMETER	TEST CONDITIONS	$T_A$	LMV821/822/824			UNIT
			MIN	TYP	MAX	
SR Slew rate <sup>(1)</sup>		25°C		1.7		V/ $\mu$ s
GBW Gain bandwidth product	(2)	25°C		6		MHz
$\Phi_m$ Phase margin	(2)	25°C		60		deg
Gain margin	(2)	25°C		8.6		dB
Amplifier-to-amplifier isolation	$V_{CC+} = 5\text{ V}$ , $R_L = 100\text{ k}\Omega$ to $2.5\text{ V}$ <sup>(3)</sup>	25°C		135		dB
$V_n$ Equivalent input noise voltage	$f = 1\text{ kHz}$ , $V_{IC} = 1\text{ V}$	25°C		45		nV/ $\sqrt{\text{Hz}}$
$I_n$ Equivalent input noise current	$f = 1\text{ kHz}$	25°C		0.18		pA/ $\sqrt{\text{Hz}}$
THD Total harmonic distortion	$f = 1\text{ kHz}$ , $A_V = -2$ , $R_L = 10\text{ k}\Omega$ , $V_O = 4.1\text{ V}_{p-p}$	25°C		0.01		%

- (1) Connected as voltage follower with 1-V step input. Value specified is the slower of the positive and negative slew rates.  
 (2) 40-dB closed-loop dc gain,  $C_L = 22\text{ pF}$   
 (3) Each amplifier excited in turn with 1 kHz to produce  $V_O = 3\text{ V}_{p-p}$

**LMV8xxI 2.7-V Electrical Characteristics**
 $V_{CC+} = 2.7\text{ V}$ ,  $V_{CC-} = 0\text{ V}$ ,  $V_{IC} = 1\text{ V}$ ,  $V_O = 1.35\text{ V}$ , and  $R_L > 1\text{ M}\Omega$  (unless otherwise noted)

PARAMETER	TEST CONDITIONS	$T_A$	LMV821/822/824			UNIT
			MIN	TYP	MAX	
$V_{IO}$ Input offset voltage		25°C	1	3.5	mV	
		-40°C to 125°C		5.5		
$\alpha_{VIO}$ Average temperature coefficient of input offset voltage		25°C	1		$\mu\text{V}/^\circ\text{C}$	
$I_{IB}$ Input bias current		25°C	30	90	nA	
		-40°C to 125°C		140		
$I_{IO}$ Input offset current		25°C	0.5	30	nA	
		-40°C to 125°C		50		
CMRR Common-mode rejection ratio	$V_{IC} = 0$ to 1.7 V	25°C	70	85	dB	
		-40°C to 125°C	68			
$+k_{SVR}$ Positive supply-voltage rejection ratio	$V_{CC+} = 1.7\text{ V}$ to 4 V, $V_{CC-} = -1\text{ V}$ , $V_O = 0$ , $V_{IC} = 0$	25°C	75	85	dB	
		-40°C to 125°C	70			
$-k_{SVR}$ Negative supply-voltage rejection ratio	$V_{CC+} = 1.7\text{ V}$ , $V_{CC-} = -1\text{ V}$ to -3.3 V, $V_O = 0$ , $V_{IC} = 0$	25°C	73	85	dB	
		-40°C to 125°C	70			
$V_{ICR}$ Common-mode input voltage range	CMRR $\geq 50$ dB	25°C	-0.2 to 1.9	-0.3 to 2	V	
$A_V$ Large-signal voltage amplification	$R_L = 600\ \Omega$ to 1.35 V, $V_O = 1.35\text{ V}$ to 2.2 V	Sourcing	25°C	90	100	dB
			-40°C to 125°C	85		
	$R_L = 600\ \Omega$ to 1.35 V, $V_O = 1.35\text{ V}$ to 0.5 V	Sinking	25°C	85	90	
			-40°C to 125°C	80		
	$R_L = 2\text{ k}\Omega$ to 1.35 V, $V_O = 1.35\text{ V}$ to 2.2 V	Sourcing	25°C	95	100	
			-40°C to 125°C	90		
	$R_L = 2\text{ k}\Omega$ to 1.35 V, $V_O = 1.35\text{ V}$ to 0.5 V	Sinking	25°C	90	95	
			-40°C to 125°C	85		
$V_O$ Output swing	$V_{CC+} = 2.7\text{ V}$ , $R_L = 600\ \Omega$ to 1.35 V	High level	25°C	2.5	2.58	V
			-40°C to 125°C	2.4		
		Low level	25°C	0.13	0.2	
			-40°C to 125°C		0.3	
	$V_{CC+} = 2.7\text{ V}$ , $R_L = 2\text{ k}\Omega$ to 1.35 V	High level	25°C	2.6	2.66	
			-40°C to 125°C	2.5		
		Low level	25°C	0.08	0.12	
			-40°C to 125°C		0.2	
$I_O$ Output current	$V_O = 0\text{ V}$	Sourcing	25°C	12	16	mA
	$V_O = 2.7\text{ V}$	Sinking	25°C	12	26	
$I_{CC}$ Supply current	LMV821		25°C	0.22	0.3	mA
			-40°C to 125°C		0.5	
	LMV822 (both amplifiers)		25°C	0.45	0.6	
			-40°C to 125°C		0.8	
	LMV824 (all four amplifiers)		25°C	0.72	1	
			-40°C to 125°C		1.2	

**LMV8xxI 2.7-V Electrical Characteristics (continued)**
 $V_{CC+} = 2.7\text{ V}$ ,  $V_{CC-} = 0\text{ V}$ ,  $V_{IC} = 1\text{ V}$ ,  $V_O = 1.35\text{ V}$ , and  $R_L > 1\text{ M}\Omega$  (unless otherwise noted)

PARAMETER	TEST CONDITIONS	$T_A$	LMV821/822/824			UNIT
			MIN	TYP	MAX	
SR Slew rate <sup>(1)</sup>		25°C		1.7		V/ $\mu$ s
GBW Gain bandwidth product	(2)	25°C		6		MHz
$\Phi_m$ Phase margin	(2)	25°C		60		deg
Gain margin	(2)	25°C		8.6		dB
Amplifier-to-amplifier isolation	$V_{CC+} = 5\text{ V}$ , $R_L = 100\text{ k}\Omega$ to $2.5\text{ V}$ <sup>(3)</sup>	25°C		135		dB
$V_n$ Equivalent input noise voltage	$f = 1\text{ kHz}$ , $V_{IC} = 1\text{ V}$	25°C		45		nV/ $\sqrt{\text{Hz}}$
$I_n$ Equivalent input noise current	$f = 1\text{ kHz}$	25°C		0.18		pA/ $\sqrt{\text{Hz}}$
THD Total harmonic distortion	$f = 1\text{ kHz}$ , $A_V = -2$ , $R_L = 10\text{ k}\Omega$ , $V_O = 4.1\text{ V}_{p-p}$	25°C		0.01		%

- (1) Connected as voltage follower with 1-V step input. Value specified is the slower of the positive and negative slew rates.  
 (2) 40-dB closed-loop dc gain,  $C_L = 22\text{ pF}$   
 (3) Each amplifier excited in turn with 1 kHz to produce  $V_O = 3\text{ V}_{p-p}$



**LMV8xx 5-V Electrical Characteristics**
 $V_{CC+} = 5\text{ V}$ ,  $V_{CC-} = 0\text{ V}$ ,  $V_{IC} = 2\text{ V}$ ,  $V_O = 2.5\text{ V}$ , and  $R_L > 1\text{ M}\Omega$  (unless otherwise noted)

PARAMETER	TEST CONDITIONS	$T_A$	LMV821/822/824			UNIT	
			MIN	TYP	MAX		
$V_{IO}$ Input offset voltage		25°C		1	3.5	mV	
		-40°C to 85°C			4		
$\alpha_{VIO}$ Average temperature coefficient of input offset voltage		25°C		1		$\mu\text{V}/^\circ\text{C}$	
$I_{IB}$ Input bias current		25°C		40	100	nA	
		-40°C to 85°C			150		
$I_{IO}$ Input offset current		25°C		0.5	30	nA	
		-40°C to 85°C			50		
CMRR Common-mode rejection ratio	$V_{IC} = 0\text{ to }4\text{ V}$	25°C	72	90		dB	
		-40°C to 85°C	70				
+ $k_{SVR}$ Positive supply-voltage rejection ratio	$V_{CC+} = 1.7\text{ V to }4\text{ V}$ , $V_{CC-} = -1\text{ V}$ , $V_O = 0$ , $V_{IC} = 0$	25°C	75	85		dB	
		-40°C to 85°C	70				
- $k_{SVR}$ Negative supply-voltage rejection ratio	$V_{CC+} = 1.7\text{ V}$ , $V_{CC-} = -1\text{ V to }-3.3\text{ V}$ , $V_O = 0$ , $V_{IC} = 0$	25°C	73	85		dB	
		-40°C to 85°C	70				
$V_{ICR}$ Common-mode input voltage range	CMRR $\geq 50\text{ dB}$	25°C	-0.2 to 4.2	-0.3 to 4.3		V	
$A_V$ Large-signal voltage amplification	$R_L = 600\ \Omega\text{ to }2.5\text{ V}$ , $V_O = 2.5\text{ V to }4.5\text{ V}$	Sourcing	25°C	95	105	dB	
			-40°C to 85°C	90			
	$R_L = 600\ \Omega\text{ to }2.5\text{ V}$ , $V_O = 2.5\text{ V to }0.5\text{ V}$	Sinking	25°C	95	105		
			-40°C to 85°C	90			
	$R_L = 2\text{ k}\Omega\text{ to }2.5\text{ V}$ , $V_O = 2.5\text{ V to }4.5\text{ V}$	Sourcing	25°C	95	105		
			-40°C to 85°C	90			
	$R_L = 2\text{ k}\Omega\text{ to }2.5\text{ V}$ , $V_O = 2.5\text{ V to }0.5\text{ V}$	Sinking	25°C	95	105		
			-40°C to 85°C	90			
$V_O$ Output swing	$V_{CC+} = 5\text{ V}$ , $R_L = 600\ \Omega\text{ to }2.5\text{ V}$	High level	25°C	4.75	4.84	V	
			-40°C to 85°C	4.7			
		Low level	25°C		0.17		0.25
			-40°C to 85°C				0.3
	$V_{CC+} = 5\text{ V}$ , $R_L = 2\text{ k}\Omega\text{ to }2.5\text{ V}$	High level	25°C	4.85	4.9		
			-40°C to 85°C	4.8			
		Low level	25°C		0.1		0.15
			-40°C to 85°C				0.2
$I_O$ Output current	$V_O = 0\text{ V}$	Sourcing	25°C	20	45	mA	
			-40°C to 85°C	15			
	$V_O = 5\text{ V}$	Sinking	25°C	20	40		
			-40°C to 85°C	15			
$I_{CC}$ Supply current	LMV821		25°C	0.3	0.4	mA	
			-40°C to 85°C		0.6		
	LMV822 (both amplifiers)		25°C	0.5	0.7		
			-40°C to 85°C		0.9		
	LMV824 (all four amplifiers)		25°C	1	1.3		
			-40°C to 85°C		1.5		

**LMV8xx 5-V Electrical Characteristics (continued)**
 $V_{CC+} = 5\text{ V}$ ,  $V_{CC-} = 0\text{ V}$ ,  $V_{IC} = 2\text{ V}$ ,  $V_O = 2.5\text{ V}$ , and  $R_L > 1\text{ M}\Omega$  (unless otherwise noted)

PARAMETER		TEST CONDITIONS	$T_A$	LMV821/822/824			UNIT
				MIN	TYP	MAX	
SR	Slew rate	$V_{CC+} = 5\text{ V}^{(1)}$	25°C	1.4	1.9		V/ $\mu$ s
GBW	Gain bandwidth product	<sup>(2)</sup>	25°C	6			MHz
$\Phi_m$	Phase margin	<sup>(2)</sup>	25°C	64.2			deg
	Gain margin	<sup>(2)</sup>	25°C	8.7			dB
	Amplifier-to-amplifier isolation	$V_{CC+} = 5\text{ V}$ , $R_L = 100\text{ k}\Omega$ to $2.5\text{ V}^{(3)}$	25°C	135			dB
$V_n$	Equivalent input noise voltage	$f = 1\text{ kHz}$ , $V_{IC} = 1\text{ V}$	25°C	42			nV/ $\sqrt{\text{Hz}}$
$I_n$	Equivalent input noise current	$f = 1\text{ kHz}$	25°C	0.2			pA/ $\sqrt{\text{Hz}}$
THD	Total harmonic distortion	$f = 1\text{ kHz}$ , $A_V = -2$ , $R_L = 10\text{ k}\Omega$ , $V_O = 4.1\text{ V}_{p-p}$	25°C	0.01			%

(1) Connected as voltage follower with 3-V step input. Value specified is the slower of the positive and negative slew rates.

(2) 40-dB closed-loop dc gain,  $C_L = 22\text{ pF}$

(3) Each amplifier excited in turn with 1 kHz to produce  $V_O = 3\text{ V}_{p-p}$

**LMV8xxI 5-V Electrical Characteristics**

$V_{CC+} = 5\text{ V}$ ,  $V_{CC-} = 0\text{ V}$ ,  $V_{IC} = 2\text{ V}$ ,  $V_O = 2.5\text{ V}$ , and  $R_L > 1\text{ M}\Omega$  (unless otherwise noted)

PARAMETER	TEST CONDITIONS	$T_A$	LMV821/822/824			UNIT	
			MIN	TYP	MAX		
$V_{IO}$ Input offset voltage		25°C		1	3.5	mV	
		-40°C to 125°C			5.5		
$\alpha_{VIO}$ Average temperature coefficient of input offset voltage		25°C		1		$\mu\text{V}/^\circ\text{C}$	
$I_{IB}$ Input bias current		25°C		40	100	nA	
		-40°C to 125°C			150		
$I_{IO}$ Input offset current		25°C		0.5	30	nA	
		-40°C to 125°C			50		
CMRR Common-mode rejection ratio	$V_{IC} = 0\text{ to }4\text{ V}$	25°C	72	90		dB	
		-40°C to 125°C	70				
$+k_{SVR}$ Positive supply-voltage rejection ratio	$V_{CC+} = 1.7\text{ V to }4\text{ V}$ , $V_{CC-} = -1\text{ V}$ , $V_O = 0$ , $V_{IC} = 0$	25°C	75	85		dB	
		-40°C to 125°C	70				
$-k_{SVR}$ Negative supply-voltage rejection ratio	$V_{CC+} = 1.7\text{ V}$ , $V_{CC-} = -1\text{ V to }-3.3\text{ V}$ , $V_O = 0$ , $V_{IC} = 0$	25°C	73	85		dB	
		-40°C to 125°C	70				
$V_{ICR}$ Common-mode input voltage range	CMRR $\geq 50\text{ dB}$	25°C	-0.2 to 4.2	-0.3 to 4.3		V	
$A_V$ Large-signal voltage amplification	$R_L = 600\ \Omega\text{ to }2.5\text{ V}$ , $V_O = 2.5\text{ V to }4.5\text{ V}$	Sourcing	25°C	95	105	dB	
			-40°C to 125°C	90			
	$R_L = 600\ \Omega\text{ to }2.5\text{ V}$ , $V_O = 2.5\text{ V to }0.5\text{ V}$	Sinking	25°C	95	105		
			-40°C to 125°C	90			
	$R_L = 2\text{ k}\Omega\text{ to }2.5\text{ V}$ , $V_O = 2.5\text{ V to }4.5\text{ V}$	Sourcing	25°C	95	105		
			-40°C to 125°C	90			
	$R_L = 2\text{ k}\Omega\text{ to }2.5\text{ V}$ , $V_O = 2.5\text{ V to }0.5\text{ V}$	Sinking	25°C	95	105		
			-40°C to 125°C	90			
$V_O$ Output swing	$V_{CC+} = 5\text{ V}$ , $R_L = 600\ \Omega\text{ to }2.5\text{ V}$	High level	25°C	4.75	4.84	V	
			-40°C to 125°C	4.6			
		Low level	25°C		0.17		0.25
			-40°C to 125°C				0.3
	$V_{CC+} = 5\text{ V}$ , $R_L = 2\text{ k}\Omega\text{ to }2.5\text{ V}$	High level	25°C	4.85	4.9		
			-40°C to 125°C	4.8			
		Low level	25°C		0.1		0.15
			-40°C to 125°C				0.2
$I_O$ Output current	$V_O = 0\text{ V}$	Sourcing	25°C	20	45	mA	
			-40°C to 125°C	15			
	$V_O = 5\text{ V}$	Sinking	25°C	20	40		
			-40°C to 125°C	15			
$I_{CC}$ Supply current	LMV821		25°C	0.3	0.4	mA	
			-40°C to 125°C		0.6		
	LMV822 (both amplifiers)		25°C	0.5	0.7		
			-40°C to 125°C		0.9		
	LMV824 (all four amplifiers)		25°C	1	1.3		
			-40°C to 125°C		1.5		

**LMV8xxI 5-V Electrical Characteristics (continued)**
 $V_{CC+} = 5\text{ V}$ ,  $V_{CC-} = 0\text{ V}$ ,  $V_{IC} = 2\text{ V}$ ,  $V_O = 2.5\text{ V}$ , and  $R_L > 1\text{ M}\Omega$  (unless otherwise noted)

PARAMETER		TEST CONDITIONS	$T_A$	LMV821/822/824			UNIT
				MIN	TYP	MAX	
SR	Slew rate	$V_{CC+} = 5\text{ V}^{(1)}$	25°C	1.4	1.9		V/ $\mu$ s
GBW	Gain bandwidth product	<sup>(2)</sup>	25°C	6			MHz
$\Phi_m$	Phase margin	<sup>(2)</sup>	25°C	64.2			deg
	Gain margin	<sup>(2)</sup>	25°C	8.7			dB
	Amplifier-to-amplifier isolation	$V_{CC+} = 5\text{ V}$ , $R_L = 100\text{ k}\Omega$ to $2.5\text{ V}^{(3)}$	25°C	135			dB
$V_n$	Equivalent input noise voltage	$f = 1\text{ kHz}$ , $V_{IC} = 1\text{ V}$	25°C	42			nV/ $\sqrt{\text{Hz}}$
$I_n$	Equivalent input noise current	$f = 1\text{ kHz}$	25°C	0.2			pA/ $\sqrt{\text{Hz}}$
THD	Total harmonic distortion	$f = 1\text{ kHz}$ , $A_V = -2$ , $R_L = 10\text{ k}\Omega$ , $V_O = 4.1\text{ V}_{p-p}$	25°C	0.01			%

(1) Connected as voltage follower with 3-V step input. Value specified is the slower of the positive and negative slew rates.

(2) 40-dB closed-loop dc gain,  $C_L = 22\text{ pF}$

(3) Each amplifier excited in turn with 1 kHz to produce  $V_O = 3\text{ V}_{p-p}$

**TYPICAL CHARACTERISTICS**

$T_A = 25^\circ\text{C}$ ,  $V_{CC+} = 5\text{-V}$  Single Supply (Unless Otherwise Noted)

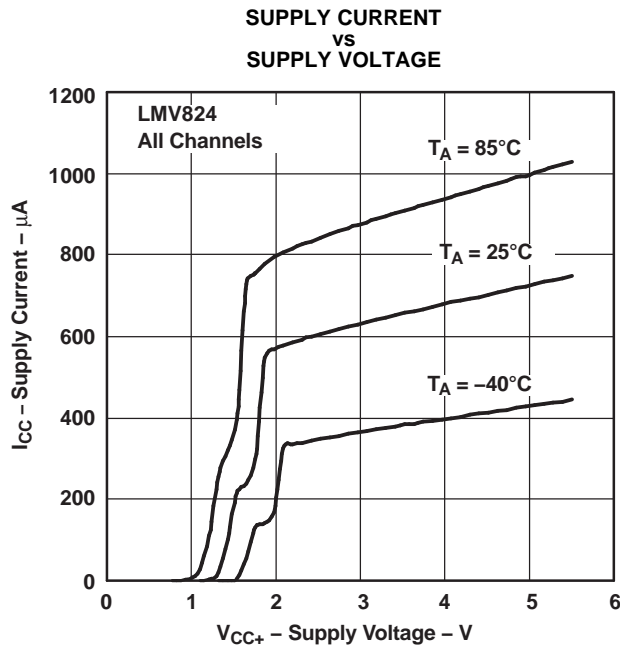

Figure 1.

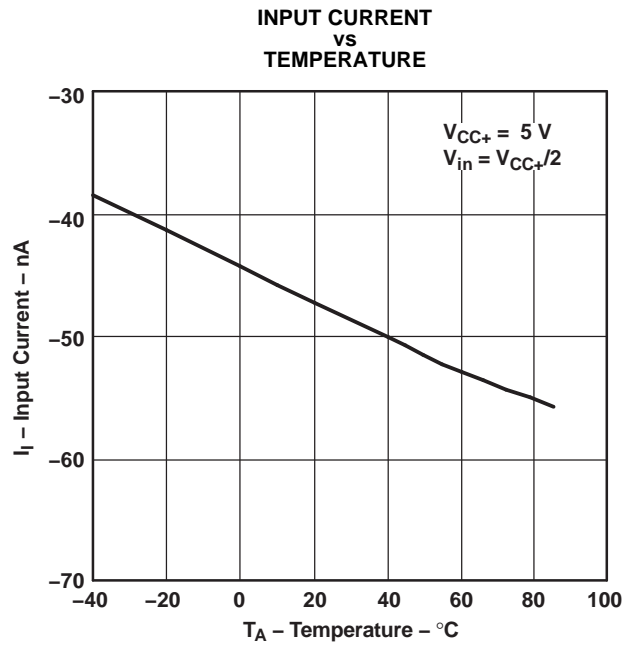

Figure 2.

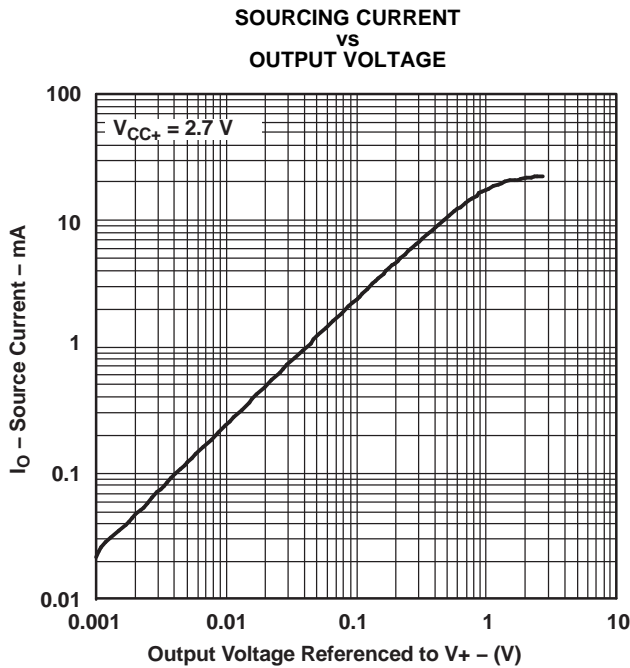

Figure 3.

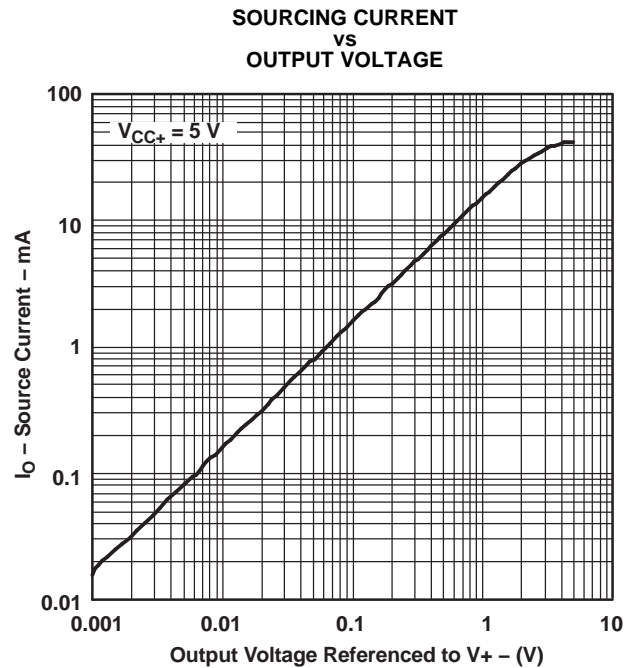

Figure 4.

**TYPICAL CHARACTERISTICS (continued)**

$T_A = 25^\circ\text{C}$ ,  $V_{CC+} = 5\text{-V}$  Single Supply (Unless Otherwise Noted)

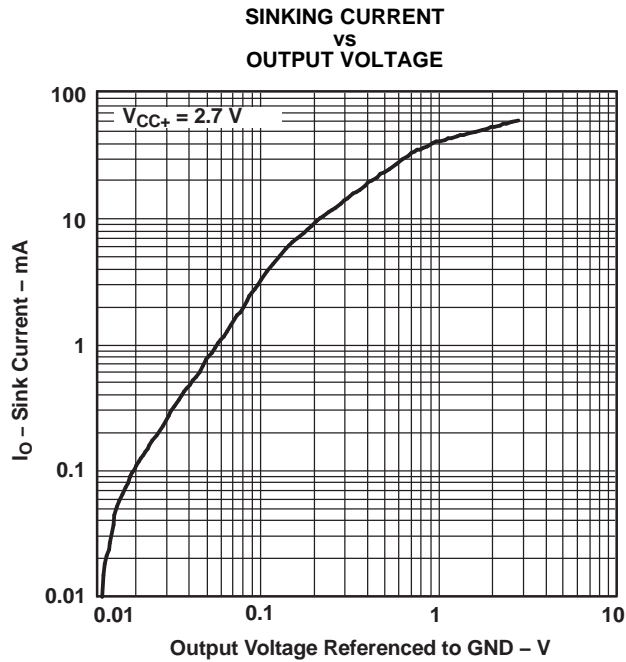

Figure 5.

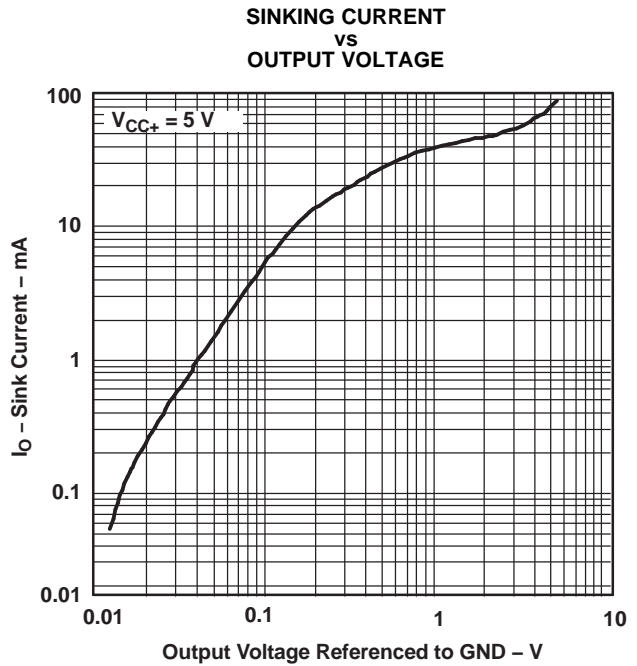

Figure 6.

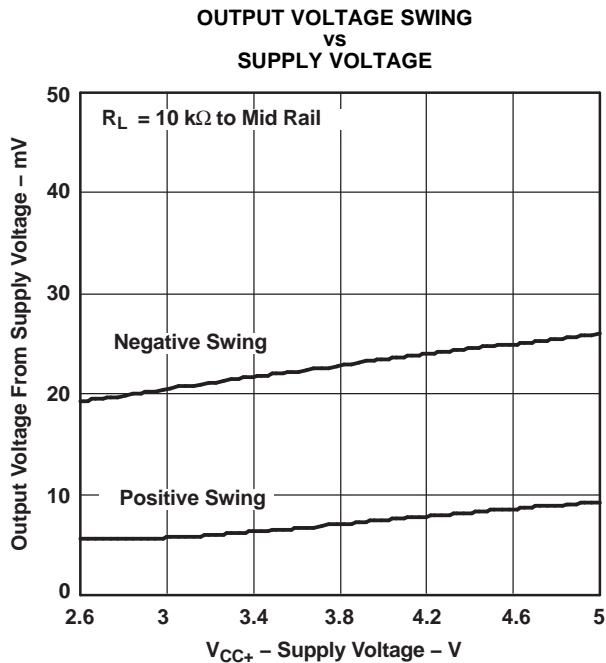

Figure 7.

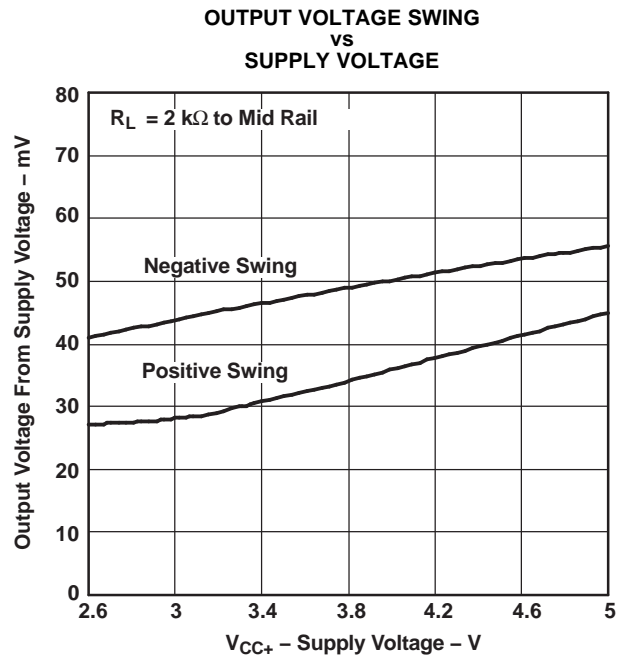
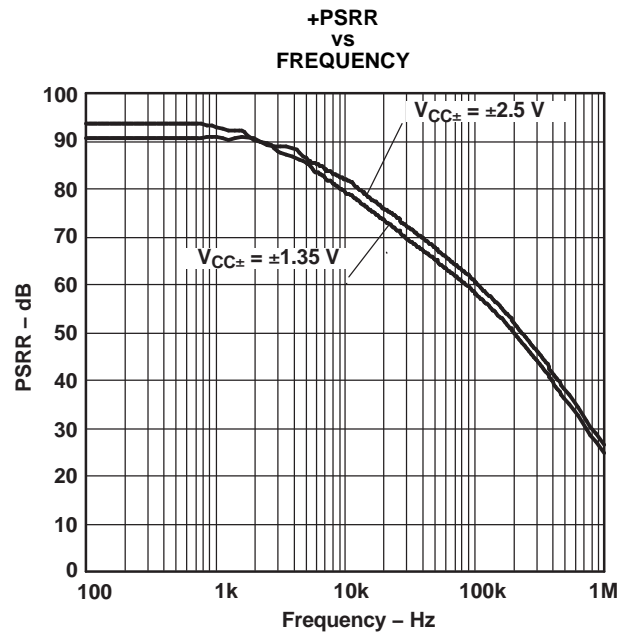
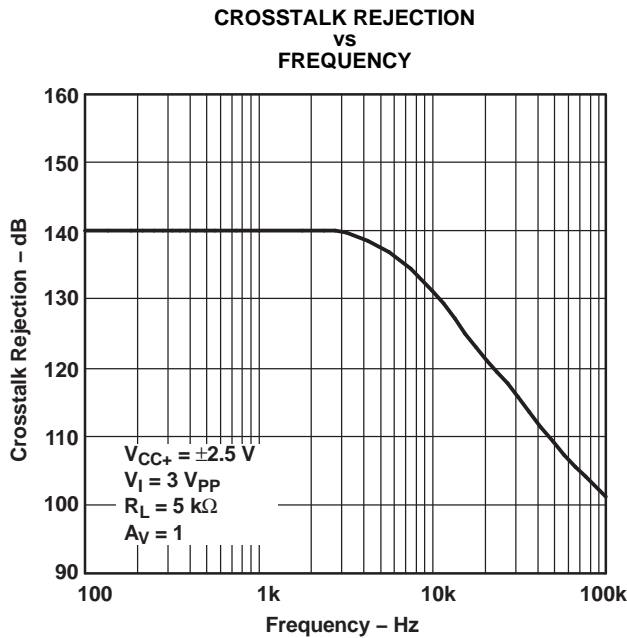
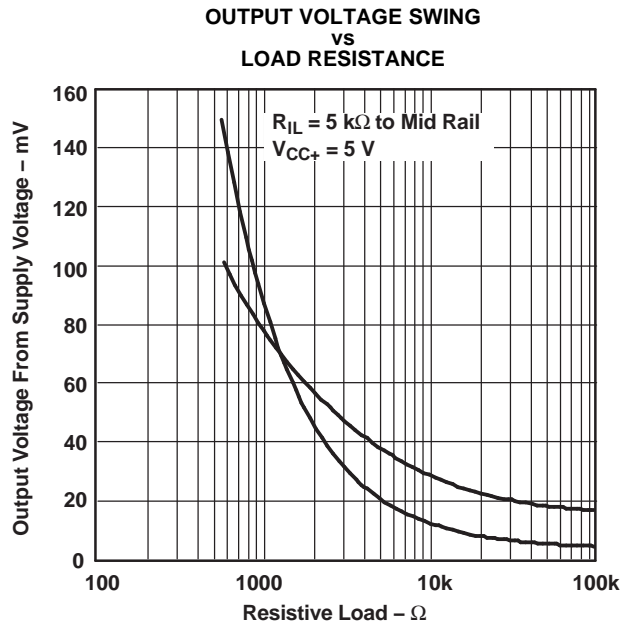
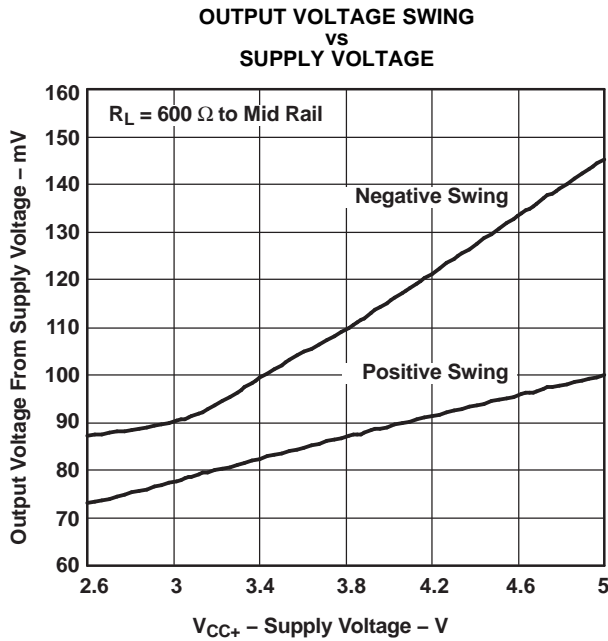

Figure 8.

**TYPICAL CHARACTERISTICS (continued)**

$T_A = 25^\circ\text{C}$ ,  $V_{CC+} = 5\text{-V}$  Single Supply (Unless Otherwise Noted)



**TYPICAL CHARACTERISTICS (continued)**

$T_A = 25^\circ\text{C}$ ,  $V_{CC+} = 5\text{-V}$  Single Supply (Unless Otherwise Noted)

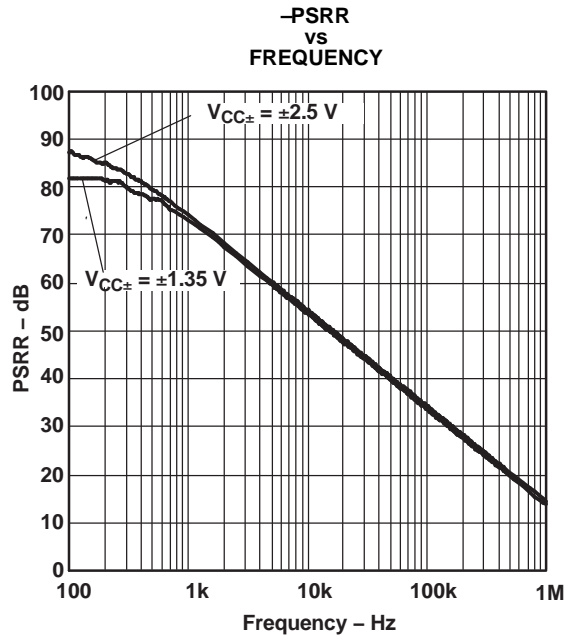

Figure 13.

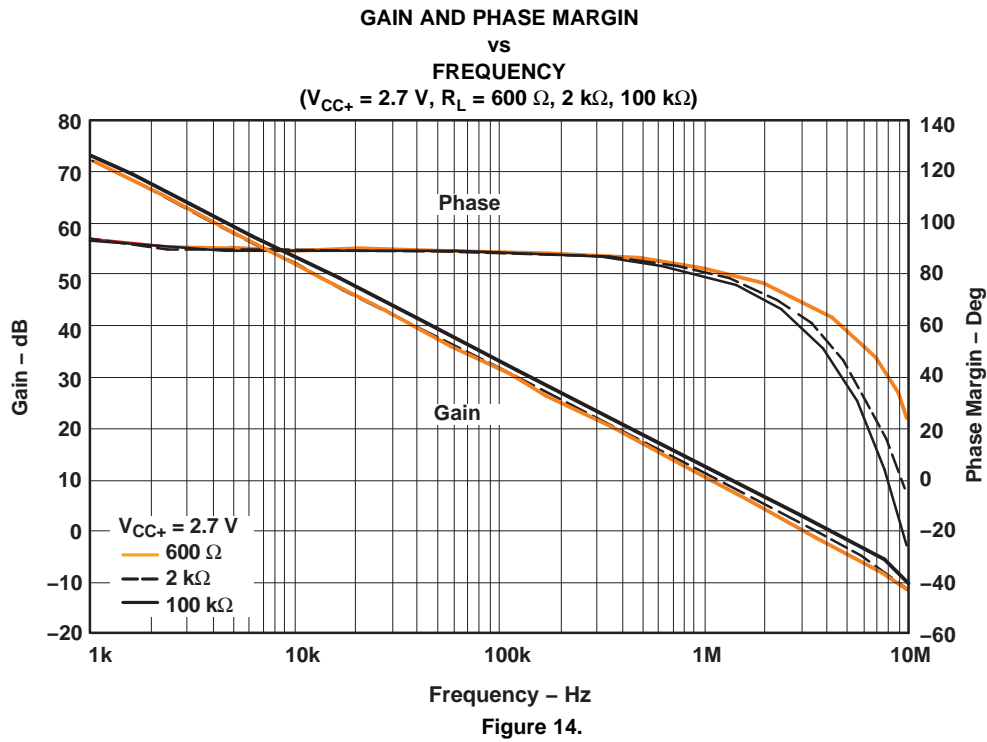
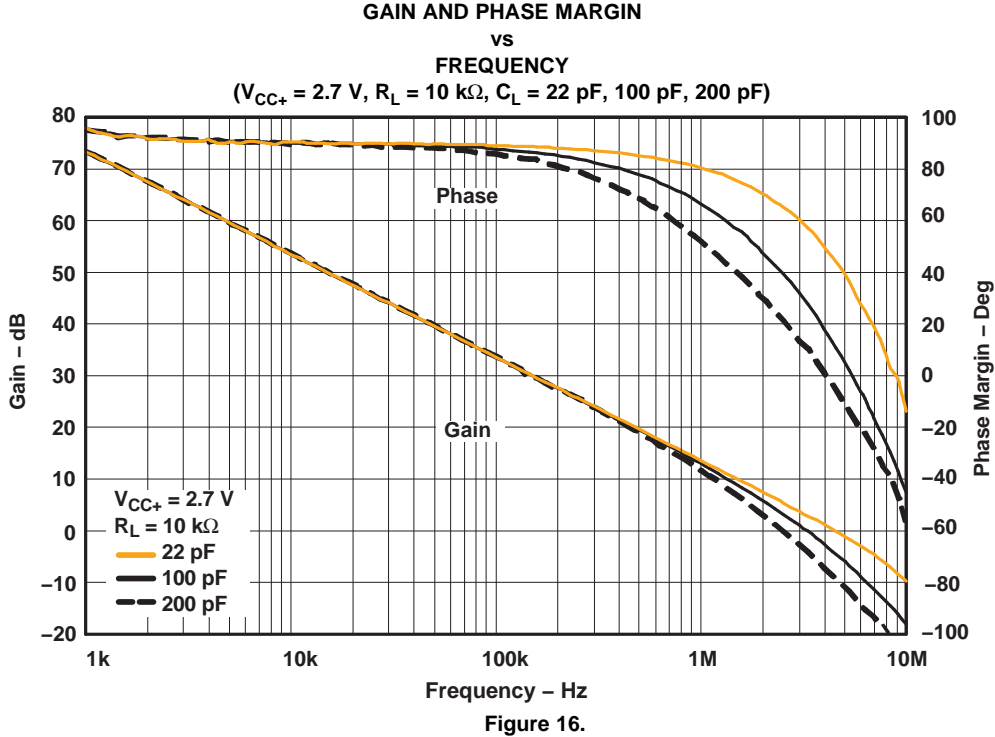
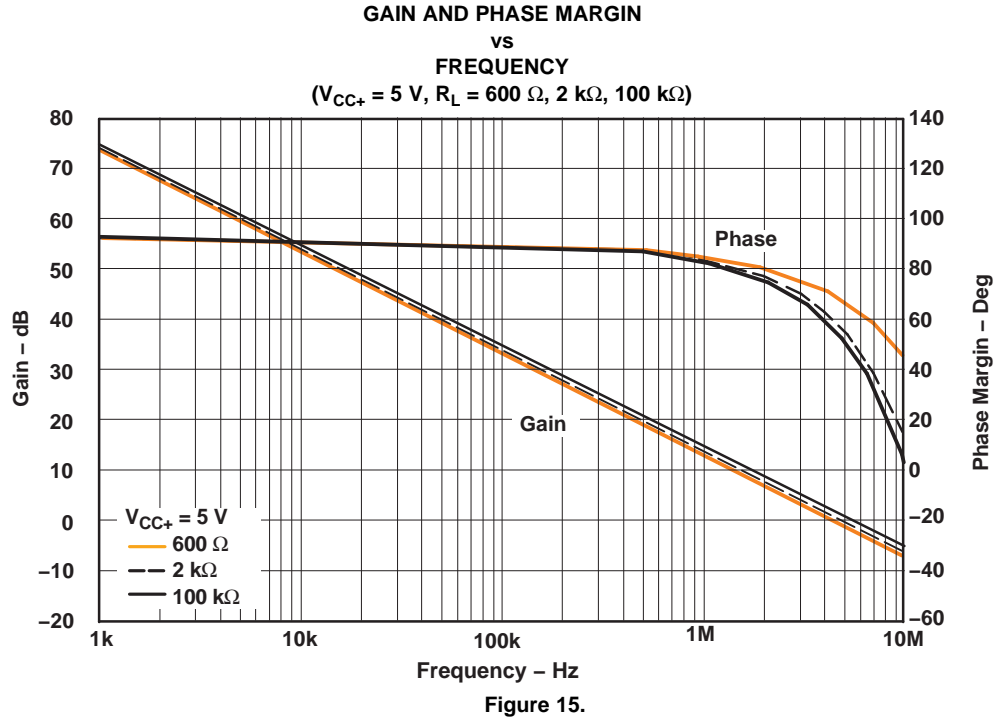

Figure 14.



**TYPICAL CHARACTERISTICS (continued)**

$T_A = 25^\circ\text{C}$ ,  $V_{CC+} = 5\text{-V}$  Single Supply (Unless Otherwise Noted)



**TYPICAL CHARACTERISTICS (continued)**

$T_A = 25^\circ\text{C}$ ,  $V_{CC+} = 5\text{-V}$  Single Supply (Unless Otherwise Noted)

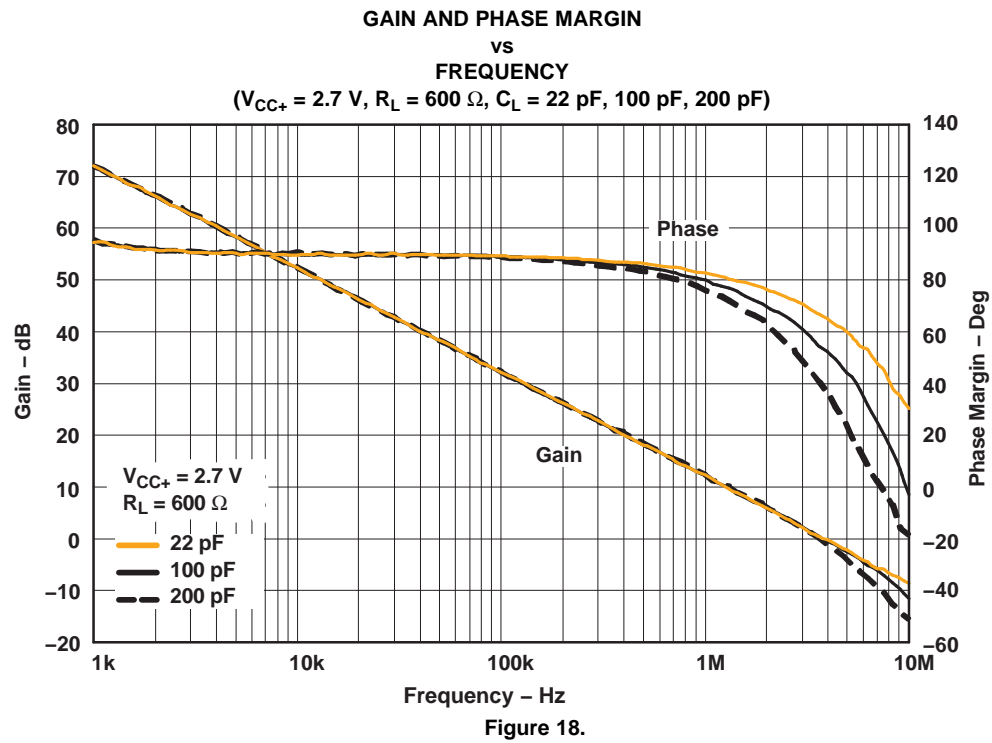
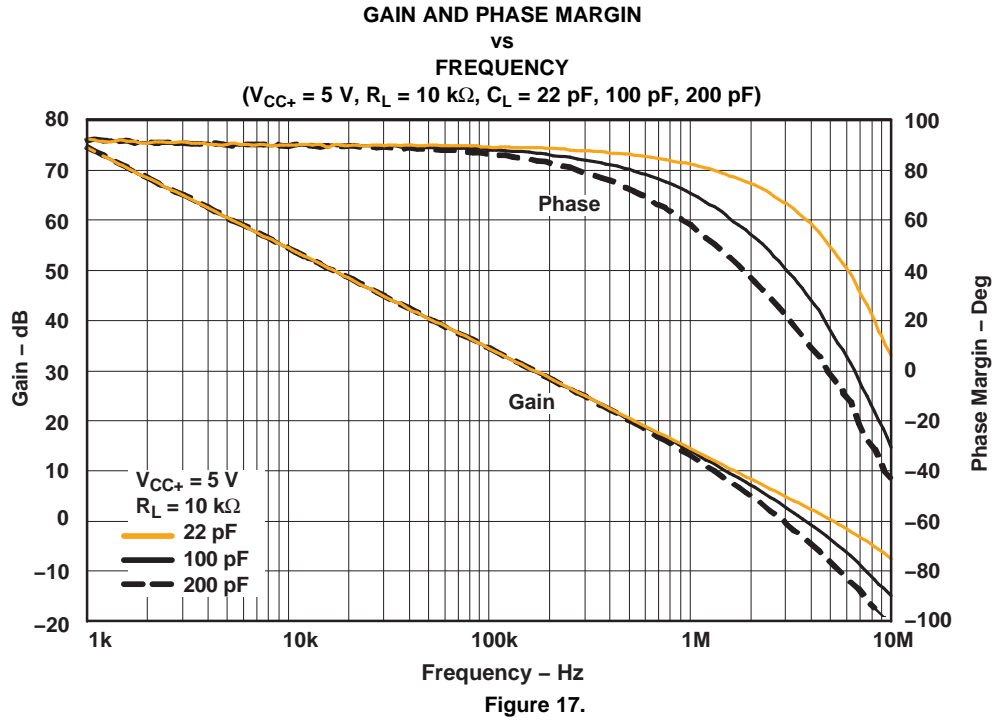

**TYPICAL CHARACTERISTICS (continued)**

$T_A = 25^\circ\text{C}$ ,  $V_{CC+} = 5\text{-V}$  Single Supply (Unless Otherwise Noted)

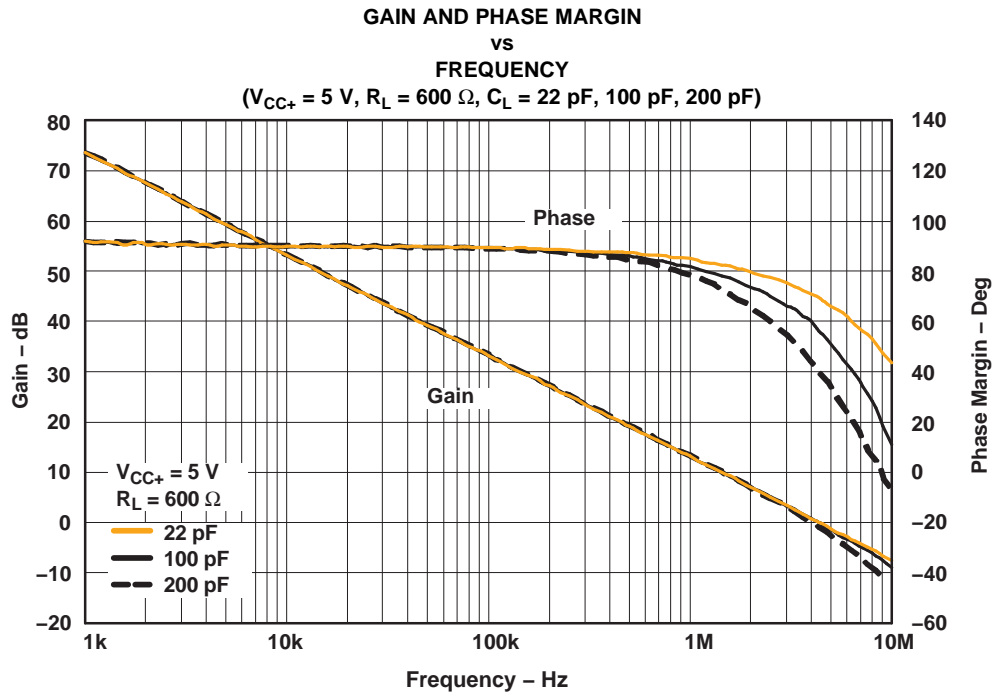

Figure 19.

### Important statement:

Huaguan Semiconductor Co,Ltd. reserves the right to change the products and services provided without notice. Customers should obtain the latest relevant information before ordering, and verify the timeliness and accuracy of this information.

Customers are responsible for complying with safety standards and taking safety measures when using our products for system design and machine manufacturing to avoid potential risks that may result in personal injury or property damage.

Our products are not licensed for applications in life support, military, aerospace, etc., so we do not bear the consequences of the application of these products in these fields.

Our documentation is only permitted to be copied without any tampering with the content, so we do not accept any responsibility or liability for the altered documents.