

# MAX14588

## 1A Adjustable Overcurrent and Overvoltage Protector with High Accuracy

### General Description

The MAX14588 adjustable overvoltage and overcurrent protection device is ideal for protecting systems against positive and negative input voltage faults up to  $\pm 40\text{V}$ , and feature low  $190\text{m}\Omega$  (typ)  $R_{\text{ON}}$  integrated FETs.

The adjustable overvoltage range is between  $6\text{V}$  and  $36\text{V}$ , while the adjustable undervoltage range is between  $4.5\text{V}$  and  $24\text{V}$ . The overvoltage lockout (OVLO) and undervoltage lockout (UVLO) thresholds are set using optional external resistors. The factory preset internal OVLO threshold is  $33\text{V}$  (typ), and the preset internal UVLO threshold is  $19\text{V}$  (typ).

The MAX14588 also features programmable current-limit protection up to  $1\text{A}$ . The device can be set for autoretry, latch-off, or continuous fault response when an overcurrent event occurs. Once current reaches the threshold, the MAX14588 turns off after  $21\text{ms}$  (typ) blanking time, and stays off during the retry period when set to autoretry mode. The device latches off after the blanking time when set to latch-off mode. The device limits the current continuously when set to continuous mode. The MAX14588 also features reverse current and thermal shutdown protection.

The MAX14588 is available in a small, 16-pin ( $3\text{mm} \times 3\text{mm}$ ) TQFN package. The MAX14588 operates over the  $-40^\circ\text{C}$  to  $+125^\circ\text{C}$  extended temperature range.

**Ordering Information** appears at end of data sheet.

### Benefits and Features

- Industrial Power Protection Increases Robustness
  - Wide Input Supply Range:  $+4.5\text{V}$  to  $+36\text{V}$
  - Negative Input Tolerance to  $-36\text{V}$
  - Low  $R_{\text{ON}}$   $190\text{m}\Omega$  (typ)
  - Reverse Current Flow Control Input
  - Thermal Overload Protection
  - Extended  $-40^\circ\text{C}$  to  $+125^\circ\text{C}$  Temperature Range
- Flexible Design Options Eases Designs
  - Adjustable OVLO and UVLO Thresholds
  - Programmable Forward-Current Limit:  $0.15\text{A}$  to  $1\text{A}$
  - Programmable Overcurrent Fault Response: Autoretry, Latch-Off, and Continuous
  - Dual Enable Inputs: EN and High Voltage HVEN
- Saves Space
  - 16-Pin,  $3\text{mm} \times 3\text{mm}$ , TQFN Package

### Applications

- Sensor Systems
- Condition Monitoring
- Factory Sensors
- Process Analytics
- Process Instrumentation
- Weighing and Batching Systems

### Typical Application Circuit

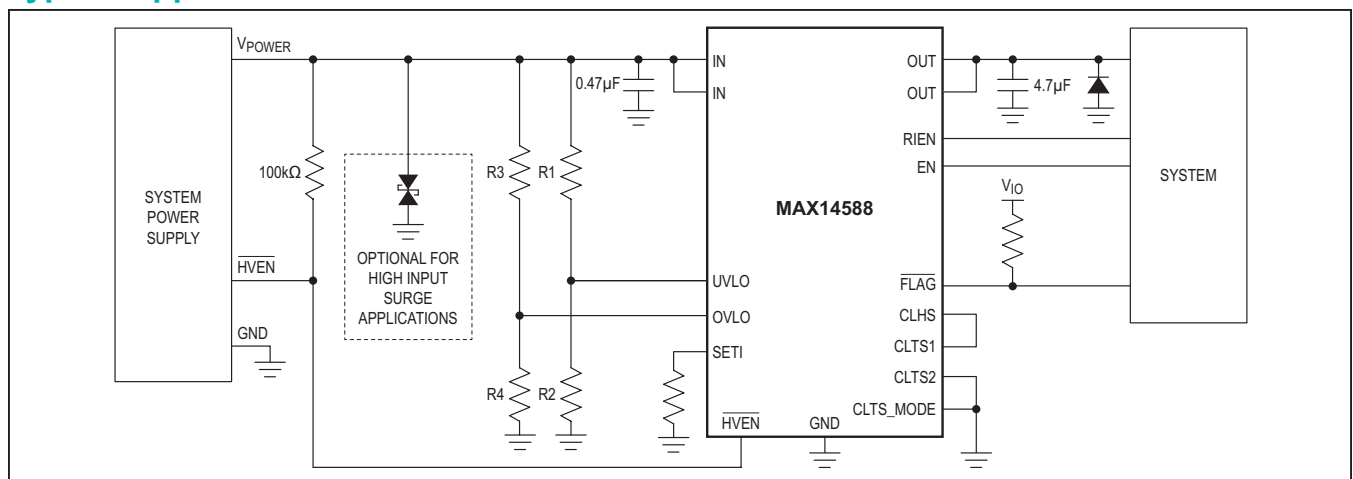

### Absolute Maximum Ratings

(All voltages referenced to GND.)

IN to GND.....	-40V to +40V
IN to OUT.....	-40V to +40V
OUT.....	-0.3V to +40V
HVEN.....	-40V to +40V
OVLO, UVLO, FLAG, EN, RIEN, CLTS1, CLTS2, CLTS_MODE.....	-0.3V to +6V
SETI.....	-0.3V to min(V <sub>IN</sub> , 1.22V)+0.3V
CLHS.....	-0.3V to min(V <sub>IN</sub> , 5V)+0.3V

I <sub>IN</sub> (DC Operating)(Note 1).....	1.0A
Continuous Power Dissipation (T <sub>A</sub> = +70°C) TQFN (derate 20.8mW/°C above +70°C).....	1667mW
Operating Temperature Range.....	-40°C to +125°C
Maximum Junction Temperature.....	+150°C
Storage Temperature Range.....	-65°C to +150°C
Lead Temperature (soldering, 10s).....	+300°C
Soldering Temperature (reflow).....	+260°C

**Note 1:** DC current is also limited by the thermal design of the system.

*Stresses beyond those listed under “Absolute Maximum Ratings” may cause permanent damage to the device. These are stress ratings only, and functional operation of the device at these or any other conditions beyond those indicated in the operational sections of the specifications is not implied. Exposure to absolute maximum rating conditions for extended periods may affect device reliability.*

### Package Thermal Characteristics (Note 2)

TQFN

Junction-to-Ambient Thermal Resistance (θ <sub>JA</sub> ).....	48°C/W	Junction-to-Case Thermal Resistance (θ <sub>JC</sub> ).....	10°C/W
--	--------	---	--------

**Note 2:** Package thermal resistances were obtained using the method described in JEDEC specification JESD51-7, using a four-layer board. For detailed information on package thermal considerations, refer to [www.maximintegrated.com/thermal-tutorial](http://www.maximintegrated.com/thermal-tutorial).

### Electrical Characteristics

(V<sub>IN</sub> = 4.5V to 36V, T<sub>A</sub> = -40°C to +125°C, unless otherwise noted. Typical values are at V<sub>IN</sub> = 24V, R<sub>SETI</sub> = 12kΩ, T<sub>A</sub> = +25°C.) (Note 3)

PARAMETER	SYMBOL	CONDITIONS	MIN	TYP	MAX	UNITS
IN Voltage	V <sub>IN</sub>		4.5		36	V
Shutdown IN Current	I <sub>SHDN</sub>	V <sub>EN</sub> = 0V, V <sub>HVEN</sub> = 5V		6.6	16	μA
Shutdown OUT Current	I <sub>OFF</sub>	V <sub>EN</sub> = 0V, V <sub>HVEN</sub> = 5V, V <sub>OUT</sub> = 0V		0.1	2	μA
Reverse IN Current	I <sub>IN_RVS</sub>	V <sub>IN</sub> = -40V, V <sub>OUT</sub> = V <sub>GND</sub> = 0V	-35	-21		μA
Supply Current	I <sub>IN</sub>	V <sub>IN</sub> = 15V, V <sub>HVEN</sub> = 0V		530	800	μA
Internal Overvoltage Trip Level	V <sub>OVLO</sub>	V <sub>IN</sub> rising	32	33	34.3	V
		V <sub>IN</sub> falling	30.3	32	33.7	
Internal Undervoltage Trip Level	V <sub>UVLO</sub>	V <sub>IN</sub> falling	17.5	18.5	19.5	V
		V <sub>IN</sub> rising	18.2	19.2	20.2	
Overvoltage Lockout Hysteresis		% of typical OVLO		3		%
External OVLO Adjustment Range		(Note 4)	6		36	V
External OVLO Select Threshold Voltage	V <sub>SEL_OVLO</sub>		0.3	0.4	0.5	V
External OVLO Leakage	I <sub>OVLO_LEAK</sub>	V <sub>OVLO</sub> < 1.2V	-100		+100	nA
External UVLO Adjustment Range		(Note 4)	4.5		24	V
External UVLO Select Threshold Voltage	V <sub>SEL_UVLO</sub>		0.3	0.4	0.5	V

## Electrical Characteristics (continued)

(V<sub>IN</sub> = 4.5V to 36V, T<sub>A</sub> = -40°C to +125°C, unless otherwise noted. Typical values are at V<sub>IN</sub> = 24V, R<sub>SET1</sub> = 12kΩ, T<sub>A</sub> = +25°C.) (Note 3)

PARAMETER	SYMBOL	CONDITIONS	MIN	TYP	MAX	UNITS
External UVLO Leakage	I <sub>UVLO_LEAK</sub>	V <sub>UVLO</sub> < 1.2V	-100		+100	nA
BG Reference Voltage	V <sub>BG</sub>		1.196	1.220	1.247	V
CLHS Voltage	V <sub>CLHS</sub>	Source 100μA	2.3	3.5		V
<b>INTERNAL FETs</b>						
Internal FETs On-Resistance	R <sub>ON</sub>	I <sub>LOAD</sub> = 100mA, V <sub>IN</sub> ≥ 8V		190	370	mΩ
Current-Limit Adjustment Range	I <sub>LIM</sub>		0.15		1.0	A
Current-Limit Accuracy		0.15A ≤ I <sub>LIM</sub> < 0.3A	-20		+20	%
		0.3A ≤ I <sub>LIM</sub> < 1.0A	-10		+10	
FLAG Assertion Drop Voltage Threshold	V <sub>FA</sub>	Increase (V <sub>IN</sub> - V <sub>OUT</sub> ) drop until FLAG asserts, V <sub>IN</sub> = 24V	400	600	800	mV
FLAG Output Logic-Low Voltage		I <sub>SINK</sub> = 1mA			0.4	V
FLAG Output Leakage Current		V <sub>IN</sub> = V <sub>FLAG</sub> = 5V, flag deasserted			2	μA
Reverse-Current Blocking Threshold	V <sub>RIB</sub>	V <sub>OUT</sub> - V <sub>IN</sub>	25	100	250	mV
Reverse-Blocking Supply Current	I <sub>RBL</sub>	V <sub>OUT</sub> - V <sub>IN</sub> > 130mV, current into OUT		430	700	μA
<b>LOGIC INPUTS</b>						
HVEN Threshold Voltage	V <sub>HVENTH</sub>		1	2	3.5	V
HVEN Threshold Hysteresis				2		%
HVEN Input Current	I <sub>HVEN_</sub>	V <sub>HVEN</sub> = 36V		26	41	μA
HVEN Input Reverse Current	I <sub>HVEN_R</sub>	V <sub>IN</sub> = V <sub>HVEN</sub> = -36V	-43	-28		μA
EN, RIEN, CLTS1, CLTS2, CLTS_MODE Input Logic-High	V <sub>IH</sub>		1.4			V
EN, RIEN, CLTS1, CLTS2, CLTS_MODE Input Logic- Low	V <sub>IL</sub>				0.4	V
EN, RIEN, CLTS1, CLTS2, CLTS_MODE Input Leakage Current	I <sub>LEAK</sub>	V <sub>LOGIC</sub> = 5V	-1		+1	μA
<b>DYNAMIC (NOTE 5)</b>						
Switch Turn-On Time	t <sub>ON</sub>	From OFF to ON (see Table 2), R <sub>LOAD</sub> = 240Ω, C <sub>OUT</sub> = 470μF		500		μs
Switch Turn-Off Time	t <sub>OFF</sub>	From ON to OFF (see Table 2), R <sub>LOAD</sub> = 47Ω, C <sub>OUT</sub> = 1μF		3		μs
Overvoltage Switch Turn-Off Time	t <sub>OFF_OVP</sub>	From (V <sub>IN</sub> > V <sub>OVLO</sub> ) to (V <sub>OUT</sub> = 80% of V <sub>IN_OVLO</sub> ), R <sub>LOAD</sub> = 47Ω		3		μs
Overcurrent Switch Turn-Off Time	t <sub>OFF_OCP</sub>	After t <sub>BLANK</sub>		3		μs

Electrical Characteristics (continued)

( $V_{IN} = 4.5V$  to  $36V$ ,  $T_A = -40^{\circ}C$  to  $+125^{\circ}C$ , unless otherwise noted. Typical values are at  $V_{IN} = 24V$ ,  $R_{SET1} = 12k\Omega$ ,  $T_A = +25^{\circ}C$ .) (Note 3)

PARAMETER	SYMBOL	CONDITIONS	MIN	TYP	MAX	UNITS
IN Debounce Time	$t_{DEB}$	From ( $V_{IN\_UVLO} < V_{IN} < V_{IN\_OVLO}$ ) and ( $EN = high$ or $HVEN = low$ ) to $V_{OUT} = 10\%$ of $V_{IN}$	14	16.5	19	ms
Blanking Time	$t_{BLANK}$		17.8	21	24.1	ms
Autoretry Time	$t_{RETRY}$	After blanking time from $I_{OUT} > I_{LIM}$ to FLAG deasserted	527	620	713	ms
<b>THERMAL PROTECTION</b>						
Thermal Shutdown				150		$^{\circ}C$
Thermal Shutdown Hysteresis				30		$^{\circ}C$

**Note 3:** All devices are 100% production tested at  $T_A = +25^{\circ}C$ . Specifications over the operating temperature range are guaranteed by design.

**Note 4:** All timing is measured using 20% and 80% levels.

Timing Diagrams

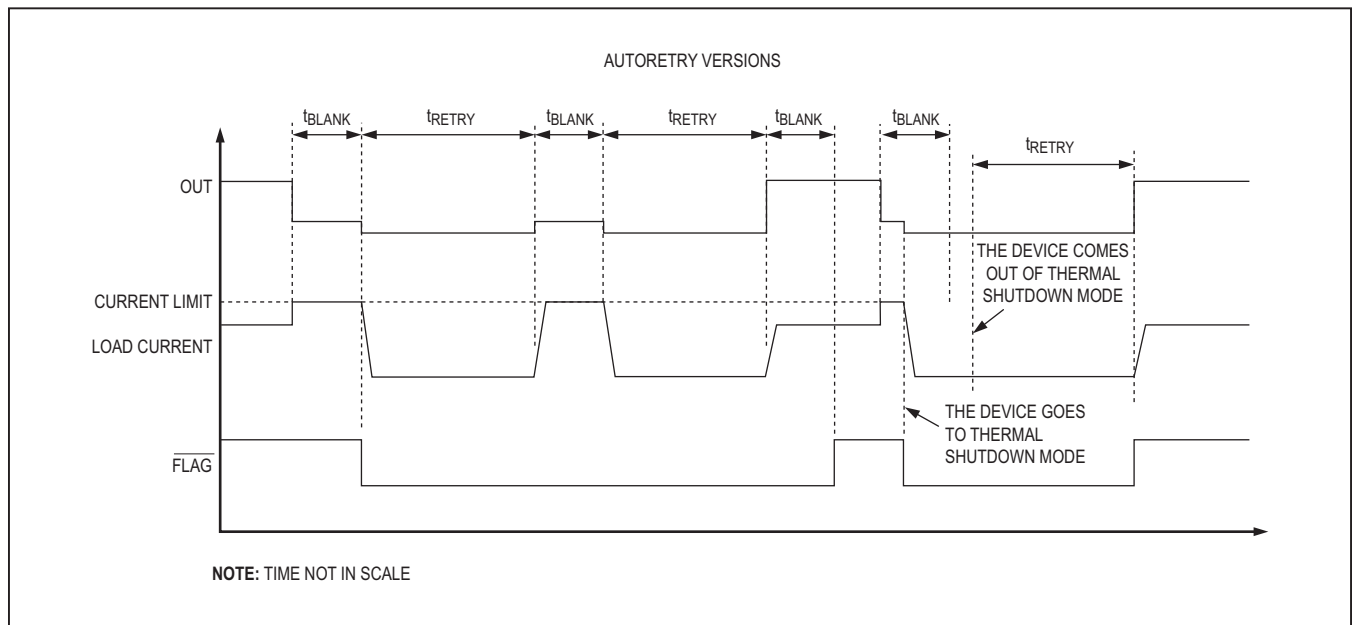

Figure 1. Autoretry Fault Diagram

Timing Diagrams (continued)

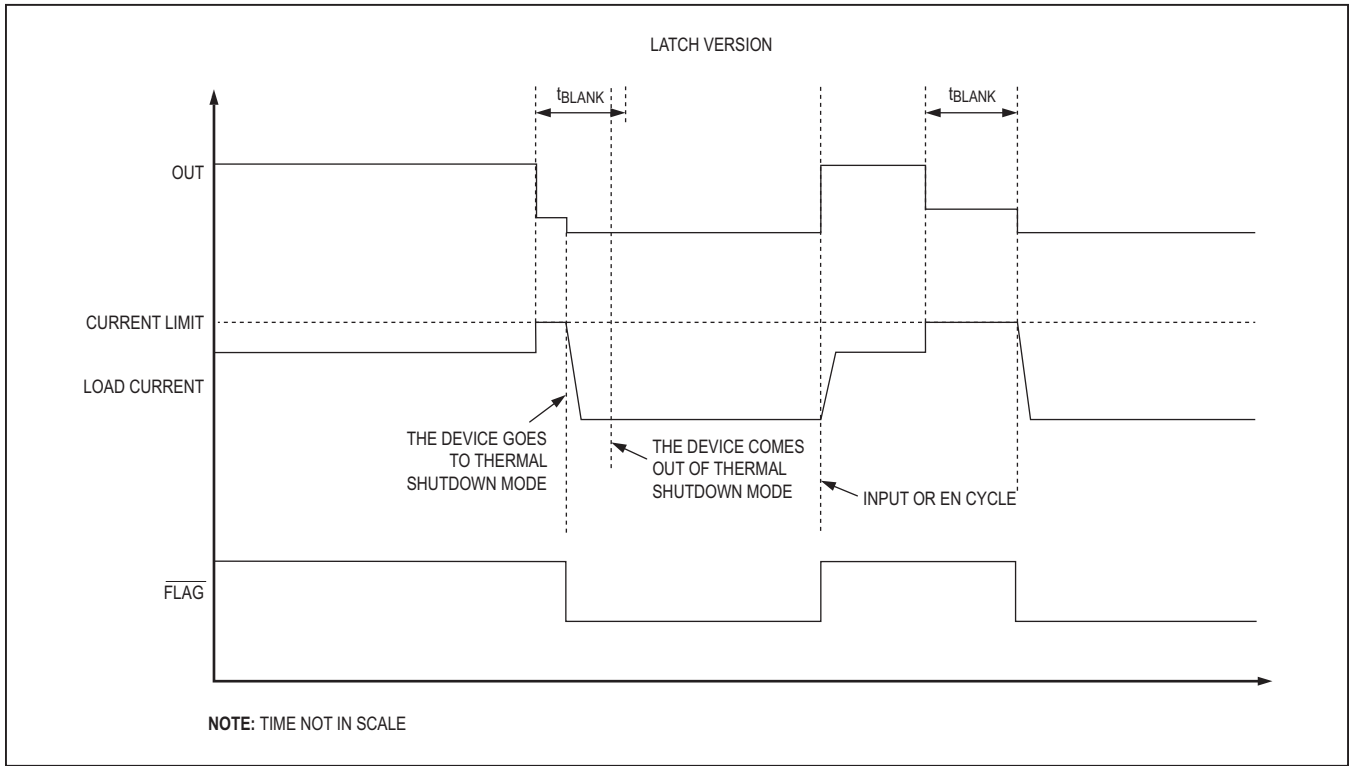

Figure 2. Latchoff Fault Diagram

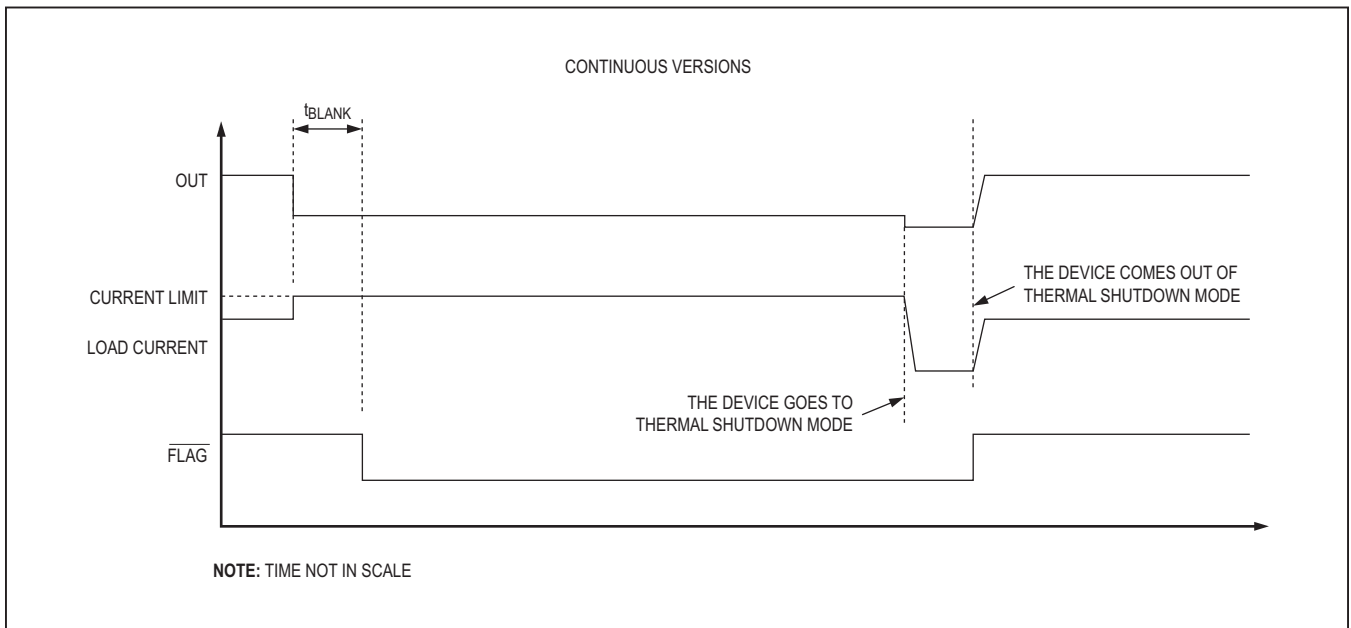

Figure 3. Continuous Fault Diagram

Timing Diagrams (continued)

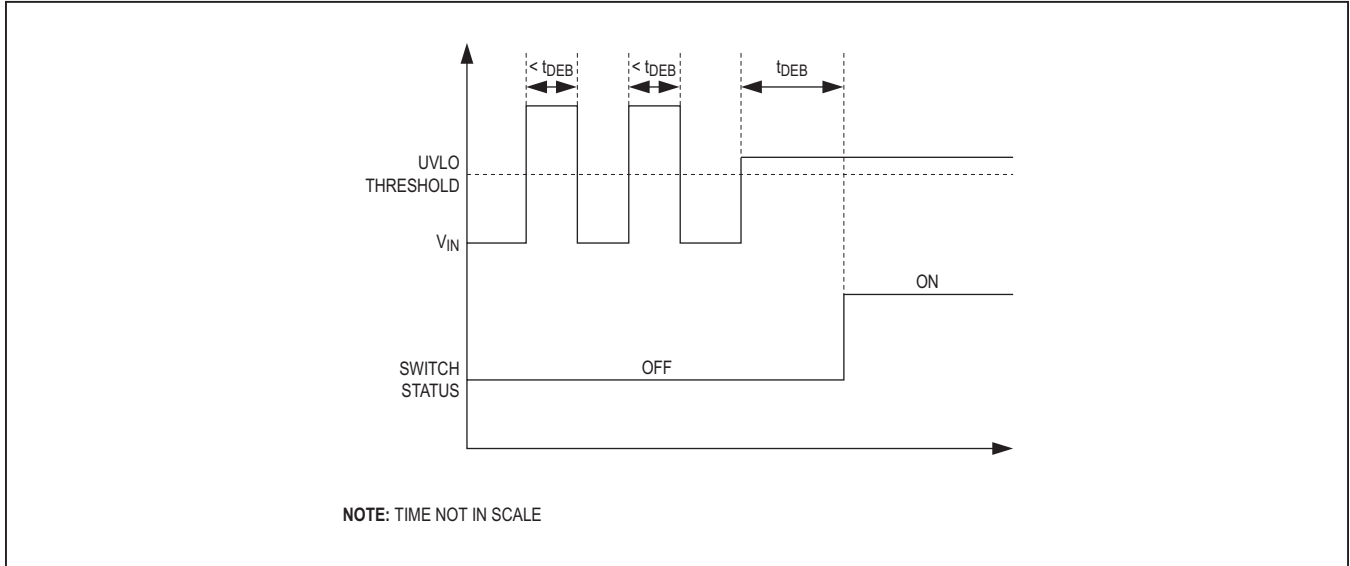
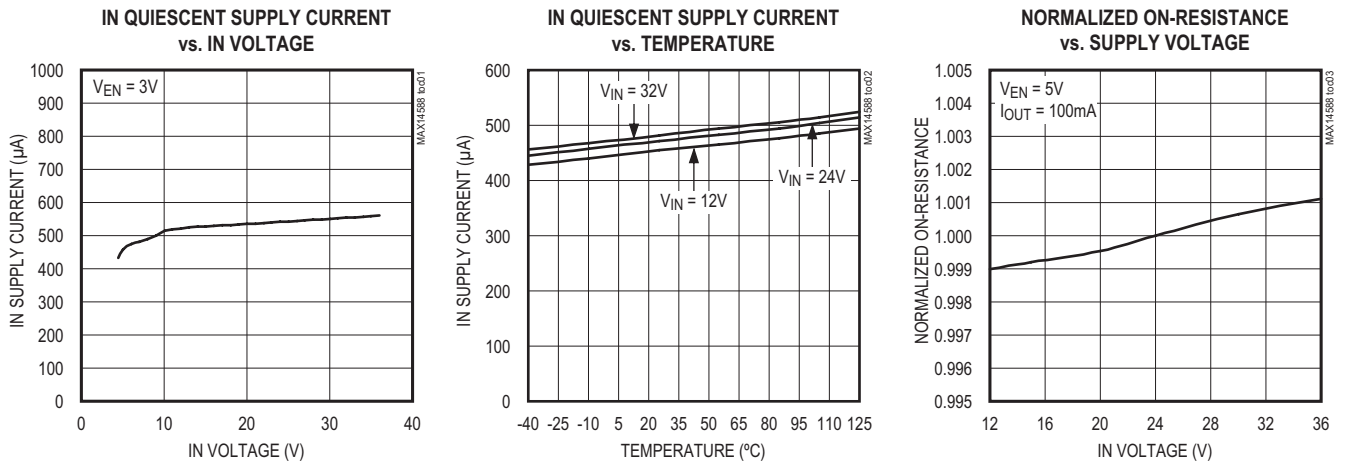

Figure 4. Debounce Timing

Typical Operating Characteristics

( $C_{IN} = 1\mu F$ ,  $C_{OUT} = 1\mu F$ ,  $T_A = +25^\circ C$ , unless otherwise noted.)



Typical Operating Characteristics (continued)

( $C_{IN} = 1\mu F$ ,  $C_{OUT} = 1\mu F$ ,  $T_A = +25^\circ C$ , unless otherwise noted.)

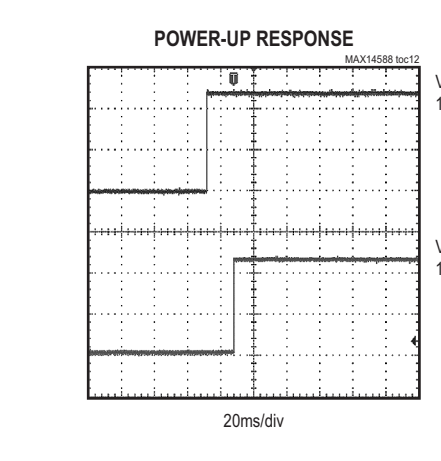
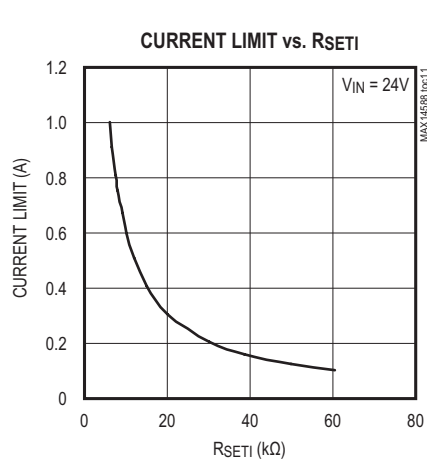
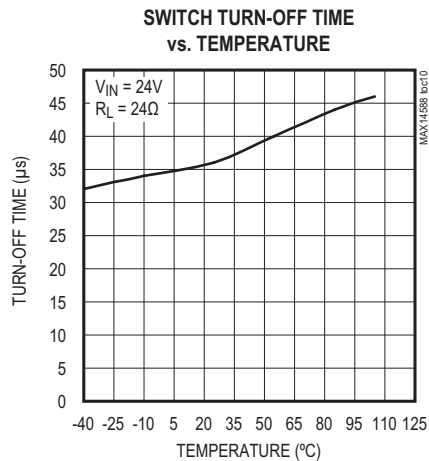
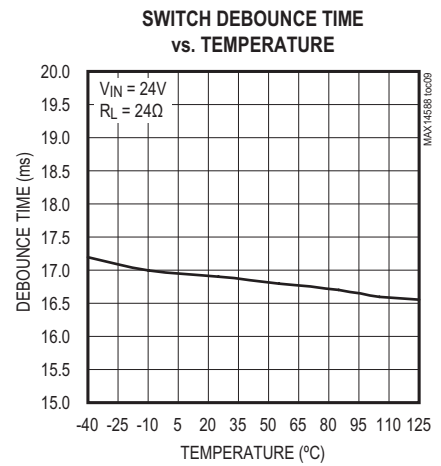
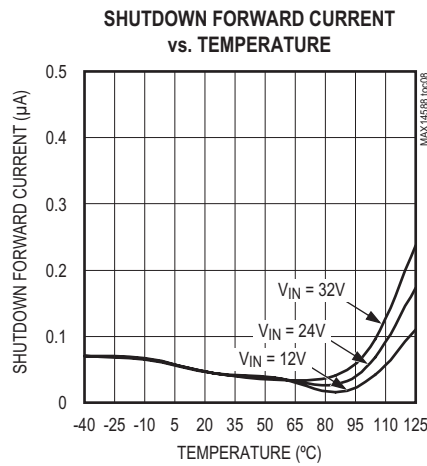
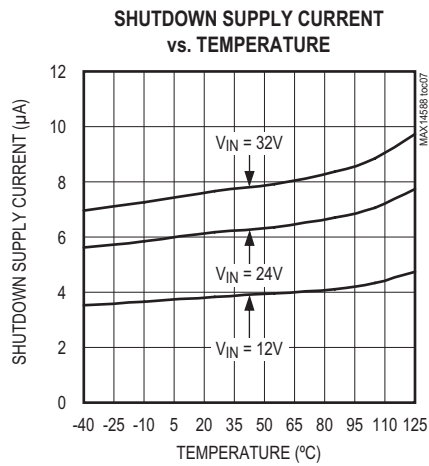
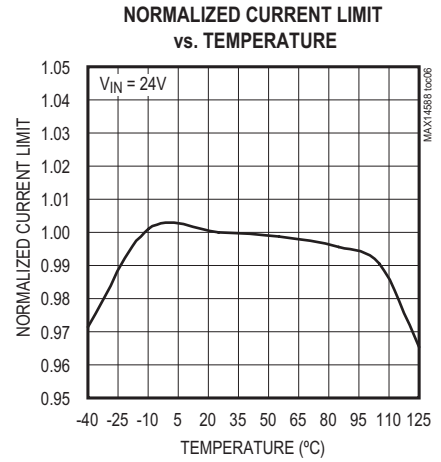
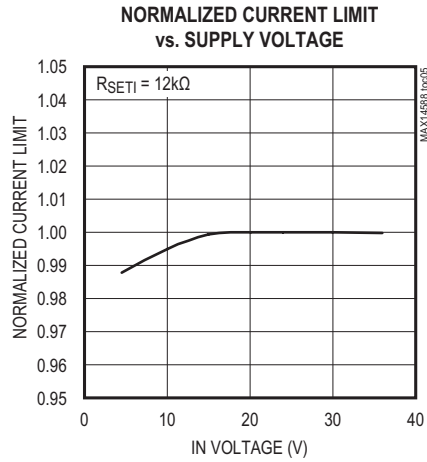
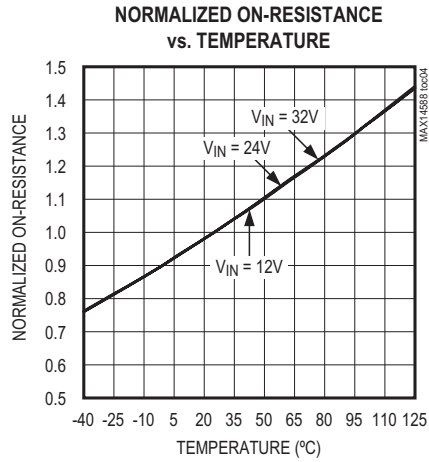

Typical Operating Characteristics (continued)

( $C_{IN} = 1\mu F$ ,  $C_{OUT} = 1\mu F$ ,  $T_A = +25^\circ C$ , unless otherwise noted.)

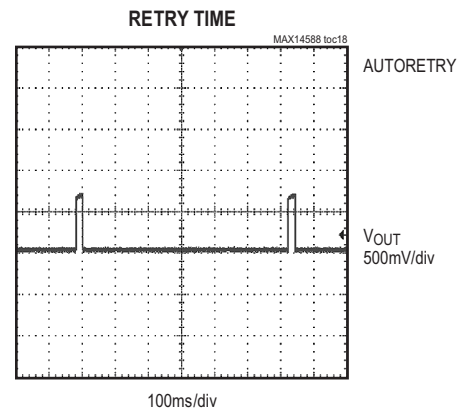
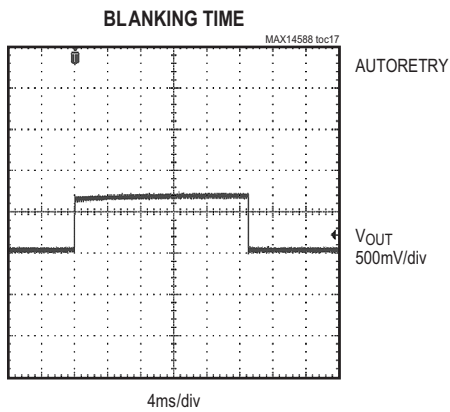
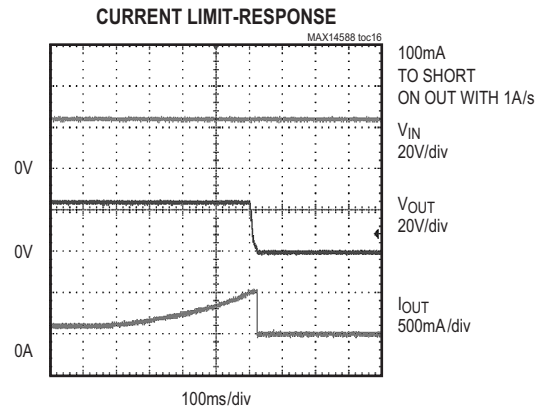
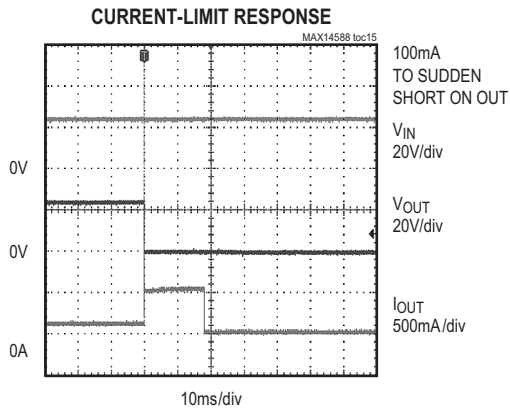
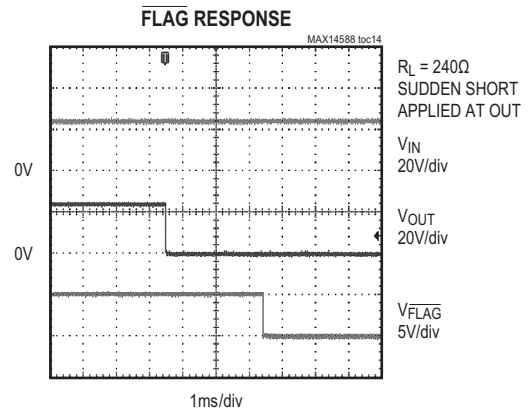
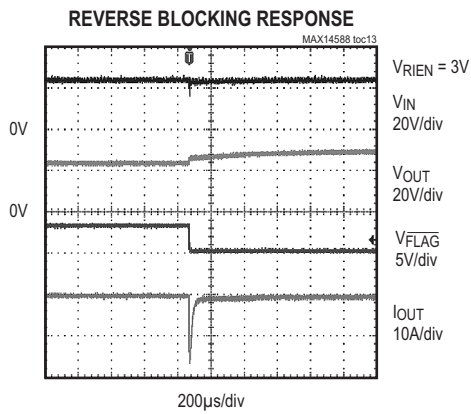



Pin Configuration

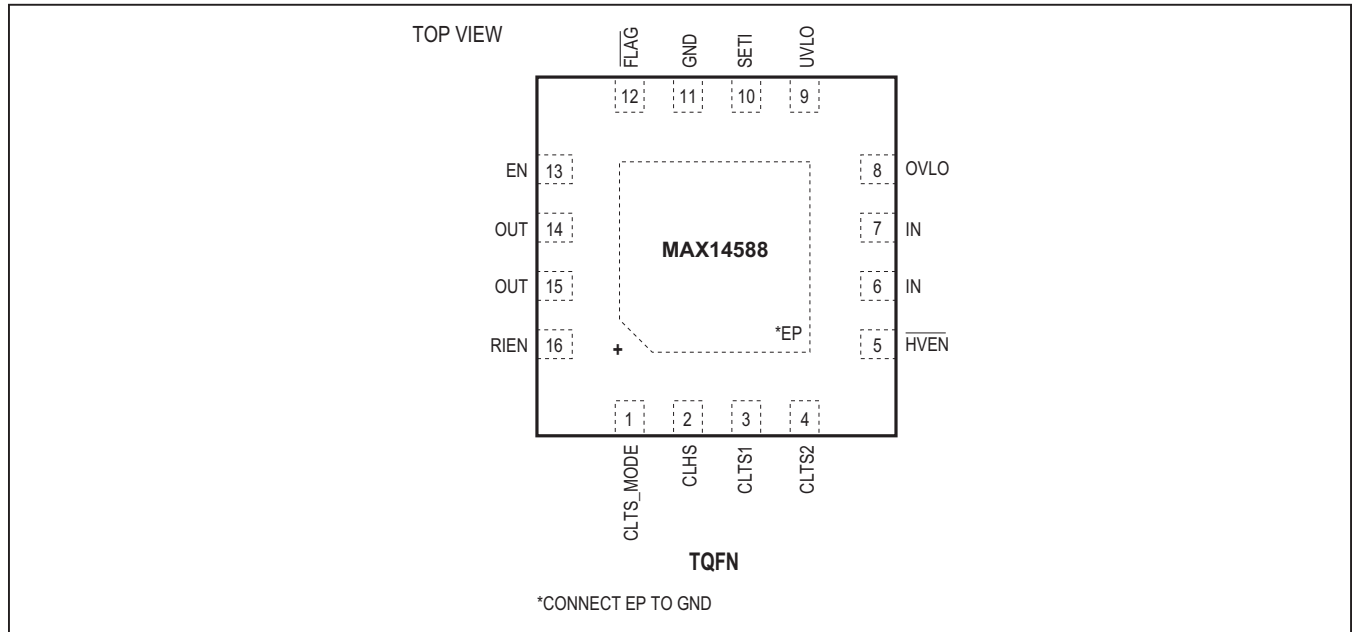

Pin Description

PIN	NAME	FUNCTION
1	CLTS_MODE	Current-Limit-Type Select Mode. CLTS_MODE = 0: CLTS1 and CLTS2 are sampled only when $(V_{IN} - V_{OUT}) < 0.6V$ . CLTS_MODE = 1: CLTS1 and CLTS2 are continuously sampled.
2	CLHS	Current-Limit-Type-Select Logic-High Voltage. Connect CLTS_MODE/CLTS1/CLTS2 to CLHS for logic-high.
3	CLTS1	Current-Limit-Type Select 1. See Table 1.
4	CLTS2	Current-Limit-Type Select 2. See Table 1.
5	HVEN	36V Capable Active-Low Enable Input. See Table 2.
6, 7	IN	Overvoltage Protection Input. Bypass IN to ground with a 0.47 $\mu$ F ceramic capacitor.
8	OVLO	Externally Programmable Overvoltage Lockout Threshold. Connect OVLO to GND to use the default internal OVLO threshold. Connect OVLO to an external resistor-divider to define a threshold externally and override the preset internal OVLO threshold.
9	UVLO	Externally Programmable Undervoltage Lockout Threshold. Connect UVLO to GND to use the default internal UVLO threshold. Connect UVLO to an external resistor-divider to define a threshold externally and override the preset internal UVLO threshold.
10	SETI	Overload-Current-Limit Adjust. Connect a resistor from SETI to GND to program the overcurrent limit. SETI must be connected to a resistor. If SETI is connected to GND, the FETs turn off and $\overline{FLAG}$ is asserted. Do not connect more than 10pF to SETI.
11	GND	Ground

Pin Description (continued)

PIN	NAME	FUNCTION
12	FLAG	Open-Drain Fault Indicator Output. FLAG goes low when the fault duration exceeds the blanking time, reverse current is detected, thermal shutdown mode is active, OVLO threshold is reached, or SETI is connected to GND.
13	EN	Active-High Enable Input. See Table 2.
14,15	OUT	Output Voltage. Output of internal FETs. Bypass OUT to GND with a 1µF ceramic capacitor placed as close to the device as possible.
16	RIEN	Reverse-Current Enable Input. Connect RIEN to GND to disable the reverse-current flow protection. Connect RIEN to logic-high to activate the reverse-current flow protection.
—	EP	Exposed Pad. Connect EP to ground. Do not use EP as the only ground connection.

Functional Diagram

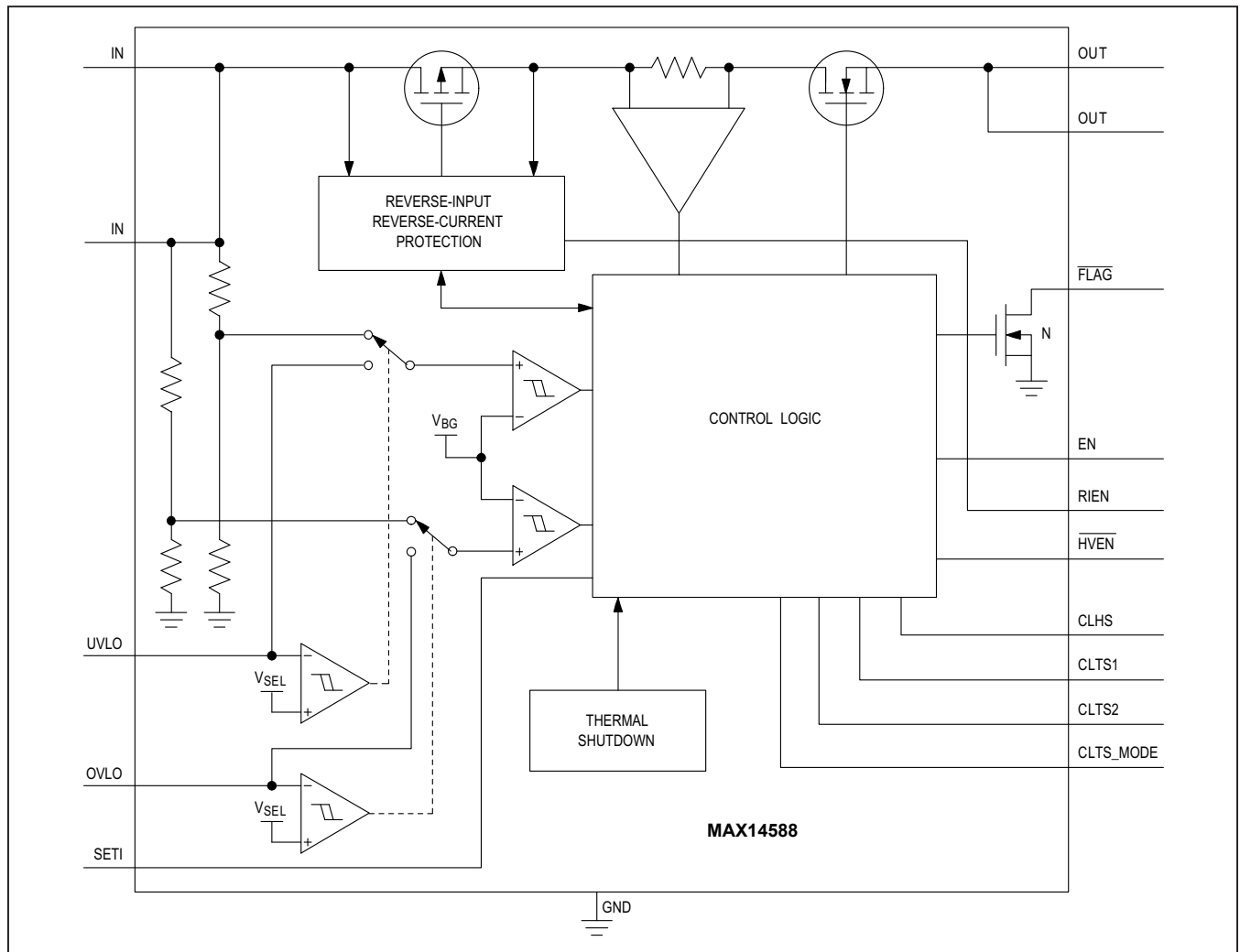

## Detailed Description

The MAX14588 is an adjustable overvoltage and overcurrent protection device designed to protect systems against positive and negative input voltage faults up to  $\pm 40\text{V}$ , and features a low  $190\text{m}\Omega$  (typ) on-resistance FET. If the input voltage exceeds the OVLO threshold or falls below the UVLO, the internal FETs are turned off to prevent damage to the protected components. If the OVLO or the UVLO pin is set below the external OVLO or UVLO select threshold ( $V_{\text{SEL\_OVLO}}$ ,  $V_{\text{SEL\_UVLO}}$ ), the device automatically selects the internal  $\pm 5\%$  accurate trip thresholds. The internal OVLO threshold is preset to  $33\text{V}$  (typ), and the internal UVLO threshold is preset to  $19\text{V}$  (typ).

### Current-Limit Type Select

The MAX14588 power-up current-limit default is continuous mode when CLTS\_MODE is low. After power up, the current-limit type can be programmed externally through CLTS1 and CLTS2 (Table 1). When CLTS\_MODE is high, CLTS1 and CLTS2 are sampled continuously. When CLTS\_MODE is low, CLTS1 and CLTS2 are sampled only when  $V_{\text{IN}} - V_{\text{OUT}} < 0.6\text{V}$ . Connect CLTS1, CLTS2, and CLTS\_MODE to CLHS for logic-high or to GND for logic-low.

### Autoretry

When the current threshold is reached, the  $t_{\text{BLANK}}$  timer begins counting. The  $\overline{\text{FLAG}}$  asserts if the overcurrent condition is present for  $t_{\text{BLANK}}$ . The timer resets if the overcurrent condition disappears before  $t_{\text{BLANK}}$  has elapsed. A retry time delay,  $t_{\text{RETRY}}$ , is started immediately after  $t_{\text{BLANK}}$  has elapsed and during  $t_{\text{RETRY}}$  time, the FETs are off. At the end of  $t_{\text{RETRY}}$ , the FETs are turned on again. If the fault still exists, the cycle is repeated and the  $\overline{\text{FLAG}}$  stays low. When the fault is removed, the FETs stay on. (Figure 1)

**Table 1. Current-Limit Type Select**

CLTS2	CLTS1	CURRENT-LIMIT TYPE
0	0	LATCH OFF
0	1	AUTORETRY
1	0	CONTINUOUS
1	1	CONTINUOUS

The autoretry feature reduces the system power in case of overcurrent or short-circuit conditions. During  $t_{\text{BLANK}}$  time, when the switch is on, the supply current is held at the current limit. During  $t_{\text{RETRY}}$  time, when the switch is off, there is no current through the switch. Thus, the output current is much less than the programmed current limit. Calculate the average output current using the following equation.

$$I_{\text{LOAD}} = I_{\text{LIM}} \left[ \frac{t_{\text{BLANK}}}{t_{\text{BLANK}} + t_{\text{RETRY}}} \right]$$

With a  $21\text{ms}$  (typ)  $t_{\text{BLANK}}$  and  $620\text{ms}$  (typ)  $t_{\text{RETRY}}$ , the duty cycle is  $3.3\%$ , resulting in a  $96.7\%$  power saving.

### Latch-Off

When the current threshold is reached, the  $t_{\text{BLANK}}$  timer begins counting. The  $\overline{\text{FLAG}}$  asserts if the overcurrent condition is present for  $t_{\text{BLANK}}$ . The timer resets when the overcurrent condition disappears before  $t_{\text{BLANK}}$  has elapsed. The switch turns off and stays off if the overcurrent condition continues beyond the blanking time. To reset the switch, either toggle the control logic EN or  $\overline{\text{HVEN}}$  or cycle the input voltage. (Figure 2)

### Continuous

When the current threshold is reached, the MAX14588 limits the output current to the programmed current limit. The  $\overline{\text{FLAG}}$  asserts if the overcurrent condition is present for  $t_{\text{BLANK}}$  and deasserts when the overload condition is removed. (Figure 3)

### Reverse-Current Block Enable (RIEN)

This feature disables the reverse-current protection and enables reverse-current flow from OUT to IN. The reverse-current block enable feature is useful in applications with inductive loads.

### Fault Flag Output

$\overline{\text{FLAG}}$  is an open-drain fault indicator output and requires an external pull-up resistor to a DC supply.  $\overline{\text{FLAG}}$  goes low when any of the following conditions occur:

- The blanking time has elapsed
- The reverse-current protection has tripped
- The die temperature exceeds  $+150^\circ\text{C}$
- SETI is connected to ground
- OVLO threshold is reached

### Thermal Shutdown Protection

The MAX14588 has a thermal-shutdown feature to protect the device from overheating. The device turns off and the  $\overline{\text{FLAG}}$  asserts when the junction temperature exceeds +150°C (typ). The devices exit thermal shutdown and resume normal operation after the junction temperature cools by 30°C (typ), except when in latch off mode, the device remains latched off.

The thermal limit behaves similar to the current limit. For autoretry mode, the thermal limit works with auto retry timer. When the device comes out of the thermal limit, it starts after the retry time. For latch off mode, the device latches off until power or EN cycle. For continuous mode, the device only disables while the temperature is over the limit. There is no blanking time for thermal protection.

### Overvoltage Lockout (OVLO)

The MAX14588 has a 33V (typ) preset OVLO threshold when the voltage at OVLO is set below the external OVLO select voltage ( $V_{\text{SEL}}$ ). Connect OVLO to GND to activate the preset OVLO threshold. Connect the external resistors to OVLO pin as shown in the *Typical Application Circuit* to externally adjust the OVLO threshold. Use the following equation to adjust the OVLO threshold. The recommended value for R3 is 2.2M $\Omega$ .

$$V_{\text{OVLO}} = V_{\text{BG}} \times \left[ 1 + \frac{R3}{R4} \right]$$

### Undervoltage Lockout (UVLO)

The MAX14588 has a 19V (typ) preset UVLO threshold when the voltage at UVLO is set below the external OVLO select voltage ( $V_{\text{SEL}}$ ). Connect UVLO to GND to activate the preset UVLO threshold. Connect the external resistors to UVLO pin as shown in the *Typical Application Circuit* to externally adjust the UVLO threshold. Use the following equation to adjust the UVLO threshold. The recommended value for R1 is 2.2M $\Omega$ .

$$V_{\text{UVLO}} = V_{\text{BG}} \times \left[ 1 + \frac{R1}{R2} \right]$$

### Switch Control

There are two independent enable inputs ( $\overline{\text{HVEN}}$  and EN) for MAX14588.  $\overline{\text{HVEN}}$  is a high-voltage capable input. Toggle  $\overline{\text{HVEN}}$  or EN to reset the fault condition once short-circuit is detected and the device shuts down (Table 2).

### Input Debounce Protection

The MAX14588 features input debounce protection. When the input voltage is higher than the UVLO threshold voltage for a period greater than the debounce time ( $t_{\text{DEB}}$ ), the internal FETs are turned on. This feature is intended for applications where the EN or  $\overline{\text{HVEN}}$  signal is present when the power supply ramps up (Figure 4).

## Applications Information

### Setting the Current Limit/Threshold

A resistor from SET1 to ground programs the current-limit/threshold value for the MAX14588. Leaving SET1 unconnected selects a 0A current limit/threshold. Connecting SET1 to ground asserts  $\overline{\text{FLAG}}$ .

Use the following formula to calculate the current limit:

$$R_{\text{SET1}}(\text{k}\Omega) = \frac{6100}{I_{\text{LIM}}(\text{mA})}$$

### IN Bypass Capacitor

Connect a minimum of 0.47 $\mu\text{F}$  capacitor from IN to GND to limit the input voltage drop during momentary output short-circuit conditions. Larger capacitor values further reduce the voltage undershoot at the input.

### Hot Plug IN

In many system powering applications, an input filtering capacitor is required to lower the radiated emission, enhance the ESD capability, etc. In hot plug applications, parasitic cable inductance along with the input capacitor causes overshoot and ringing when the powered cable is connected to the input terminal.

This effect causes the protection device to see almost twice the applied voltage. An input voltage of 24V can easily exceed the absolute maximum rating of 40V, which may permanently damage the device. A transient voltage suppressor (TVS) is often used for industrial applications to protect the system from these conditions. We recommend using a TVS that is capable of limiting the input surge to 40V placed close to the input terminal.

**Table 2. Enable Inputs**

$\overline{\text{HVEN}}$	EN	SWITCH STATUS
0	0	ON
0	1	ON
1	0	OFF
1	1	ON

**OUT Bypass Capacitor**

For stable operation over the full temperature range and over the entire programmable current-limit range, connect a 4.7 $\mu$ F ceramic capacitor from OUT to ground. Excessive output capacitance can cause a false overcurrent condition due to decreased dv/dt across the capacitor. Calculate the maximum capacitive load ( $C_{MAX}$ ) value that can be connected to OUT by using the following formula:

$$C_{MAX}(\mu F) = \frac{I_{LIM} \text{ (mA)} \times t_{BLANK(TYP)} \text{ (ms)}}{V_{IN} \text{ (V)}}$$

For example, for  $V_{IN} = 24V$ ,  $t_{BLANK(TYP)} = 20ms$ , and  $I_{LIM} = 1A$ ,  $C_{MAX}$  equals 833 $\mu$ F.

**Output Freewheeling Diode for Inductive Hard Short to Ground**

In applications that require protection from a sudden short to ground with an inductive load or a long cable, a schottky diode between the OUT terminal and ground is recommended. This is to prevent a negative spike on the OUT due to the inductive kickback during a short-circuit event.

**Layout and Thermal Dissipation**

To optimize the switch response time to output short-circuit conditions, it is very important to keep all traces as short as possible to reduce the effect of undesirable parasitic inductance. Place input and output capacitors as close as possible to the device (no more than 5mm). IN and OUT must be connected with wide short traces to the power bus. During normal operation, the power dissipation is small and the package temperature change is minimal. If the output is continuously shorted to ground at the maximum supply voltage, the switches with the autoretry option do not cause thermal shutdown detection to trip:

$$P_{(MAX)} = \frac{V_{IN(MAX)} \times I_{OUT(MAX)} \times t_{BLANK}}{t_{RETRY} + t_{BLANK}}$$

Attention must be given to continuous current-limit mode when the power dissipation during a fault condition can cause the device to reach the thermal shutdown threshold. Thermal vias from the exposed pad to ground plane are highly recommended to increase the system thermal capacitance while reducing the thermal resistance to the ambient.

## Ordering Information

PART	TEMP RANGE	TOP MARK	PIN-PACKAGE
MAX14588ETE+T	-40°C to +125°C	AJZ	16 TQFN-EP*

+ Denotes a lead(Pb)-free package/RoHS-compliant package.

T = Tape and reel

\*EP = Exposed Pad

## Chip Information

PROCESS: BiCMOS

## Package Information

For the latest package outline information and land patterns (footprints), go to [www.maximintegrated.com/packages](http://www.maximintegrated.com/packages). Note that a "+", "#", or "-" in the package code indicates RoHS status only. Package drawings may show a different suffix character, but the drawing pertains to the package regardless of RoHS status.

PACKAGE TYPE	PACKAGE CODE	OUTLINE NO.	LAND PATTERN NO.
16 TQFN-EP	T1633+5	<a href="#">21-0136</a>	<a href="#">90-0032</a>

## Revision History

REVISION NUMBER	REVISION DATE	DESCRIPTION	PAGES CHANGED
0	12/12	Initial release	—
1	6/16	Updated <i>Functional Diagram</i>	10

For pricing, delivery, and ordering information, please contact Maxim Direct at 1-888-629-4642, or visit Maxim Integrated's website at [www.maximintegrated.com](http://www.maximintegrated.com).

*Maxim Integrated cannot assume responsibility for use of any circuitry other than circuitry entirely embodied in a Maxim Integrated product. No circuit patent licenses are implied. Maxim Integrated reserves the right to change the circuitry and specifications without notice at any time. The parametric values (min and max limits) shown in the Electrical Characteristics table are guaranteed. Other parametric values quoted in this data sheet are provided for guidance.*