

1-Bit Dual-Supply Non-Inverting Level Translator

NLSV1T34

The NLSV1T34 is a 1-bit configurable dual-supply voltage level translator. The input A_n and output B_n ports are designed to track two different power supply rails, V_{CCA} and V_{CCB} respectively. Both supply rails are configurable from 0.9 V to 4.5 V allowing universal low-voltage translation from the input A_n to the output B_n port.

Features

- Wide V_{CCA} and V_{CCB} Operating Range: 0.9 V to 4.5 V
- High-Speed w/ Balanced Propagation Delay
- Inputs and Outputs have OVT Protection to 4.5 V
- Non-preferential V_{CCA} and V_{CCB} Sequencing
- Power-Off Protection
- Power-Off High Impedance Inputs and Outputs
- Ultra-Small Packaging: 1.45 mm x 1.0 mm ULLGA6
2.0 mm x 2.1 mm SC-88A
1.2 mm x 1.0 mm UDFN6
1.45 mm x 1.0 mm UDFN6
- NLV Prefix for Automotive and Other Applications Requiring Unique Site and Control Change Requirements; AEC-Q100 Qualified and PPAP Capable
- These are Pb-Free Devices

Typical Applications

- Mobile Phones, PDAs, Other Portable Devices

Important Information

- ESD Protection for All Pins:
HBM (Human Body Model) > 3000 V

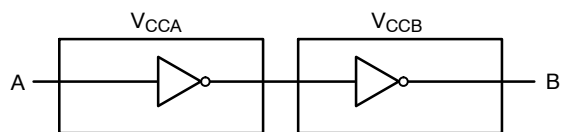







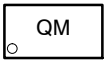

Figure 1. Logic Diagram



ON Semiconductor®

www.onsemi.com

MARKING DIAGRAMS

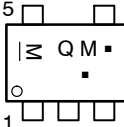
	UDFN6 MU SUFFIX CASE 517AA	
	UDFN6 MU SUFFIX CASE 517AQ	
	ULLGA6 MX1 SUFFIX CASE 613AF	
	SC-88A (SOT-353/SC-70) DF SUFFIX CASE 419A	

Q, A = Device Code
M = Date Code*
▪ = Pb-Free Package

(Note: Microdot may be in either location)

*Date Code orientation and/or position may vary depending upon manufacturing location.

PIN ASSIGNMENT

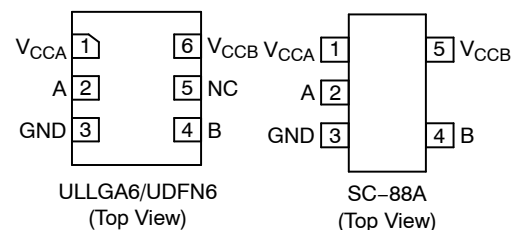

ORDERING INFORMATION

See detailed ordering and shipping information on page 5 of this data sheet.

NLSV1T34

PIN ASSIGNMENT

PIN	FUNCTION
V _{CCA}	Input Port DC Power Supply
V _{CCB}	Output Port DC Power Supply
GND	Ground
A	Input Port
B	Output Port

TRUTH TABLE

INPUTS	OUTPUTS
A	B
L	L
H	H

MAXIMUM RATINGS

Symbol	Rating	Value	Condition	Unit	
V _{CCA} , V _{CCB}	DC Supply Voltage	-0.5 to +5.5		V	
V _I	DC Input Voltage	A	-0.5 to +5.5	V	
V _O	DC Output Voltage (Power Down)	B	-0.5 to +5.5	V _{CCA} = V _{CCB} = 0	V
	(Active Mode)	B	-0.5 to +5.5		V
I _{IK}	DC Input Diode Current	-20	V _I < GND	mA	
I _{OK}	DC Output Diode Current	-50	V _O < GND	mA	
I _O	DC Output Source/Sink Current	±50		mA	
I _{CCA} , I _{CCB}	DC Supply Current Per Supply Pin	±100		mA	
I _{GND}	DC Ground Current per Ground Pin	±100		mA	
T _{STG}	Storage Temperature	-65 to +150		°C	

Stresses exceeding those listed in the Maximum Ratings table may damage the device. If any of these limits are exceeded, device functionality should not be assumed, damage may occur and reliability may be affected.

RECOMMENDED OPERATING CONDITIONS

Symbol	Parameter	Min	Max	Unit
V _{CCA} , V _{CCB}	Positive DC Supply Voltage	0.9	4.5	V
V _I	Bus Input Voltage	GND	4.5	V
V _{IO}	Bus Output Voltage (Power Down Mode)	B	4.5	V
	(Active Mode)	B	V _{CCB}	V
T _A	Operating Temperature Range	-40	+85	°C
Δt / ΔV	Input Transition Rise or Rate V _I , from 30% to 70% of V _{CC} ; V _{CC} = 3.3 V ±0.3 V	0	10	nS

Functional operation above the stresses listed in the Recommended Operating Ranges is not implied. Extended exposure to stresses beyond the Recommended Operating Ranges limits may affect device reliability.

NLSV1T34

DC ELECTRICAL CHARACTERISTICS

Symbol	Parameter	Test Conditions	V _{CCA} (V)	V _{CCB} (V)	-40°C to +85°C		Unit
					Min	Max	
V _{IH}	Input HIGH Voltage		3.6 – 4.5	0.9 – 4.5	2.2	–	V
			2.7 – 3.6		2.0	–	
			2.3 – 2.7		1.6	–	
			1.4 – 2.3		0.65 * V _{CCA}	–	
			0.9 – 1.4		0.9 * V _{CCA}	–	
V _{IL}	Input LOW Voltage		3.6 – 4.5	0.9 – 4.5	–	0.8	V
			2.7 – 3.6		–	0.8	
			2.3 – 2.7		–	0.7	
			1.4 – 2.3		–	0.35 * V _{CCA}	
			0.9 – 1.4		–	0.1 * V _{CCA}	
V _{OH}	Output HIGH Voltage	I _{OH} = –100 μA; V _I = V _{IH}	0.9 – 4.5	0.9 – 4.5	V _{CCB} – 0.2	–	V
		I _{OH} = –0.5 mA; V _I = V _{IH}	0.9	0.9	0.75 * V _{CCB}	–	
		I _{OH} = –2 mA; V _I = V _{IH}	1.4	1.4	1.05	–	
		I _{OH} = –6 mA; V _I = V _{IH}	1.65	1.65	1.25	–	
			2.3	2.3	2.0	–	
		I _{OH} = –12 mA; V _I = V _{IH}	2.3	2.3	1.8	–	
			2.7	2.7	2.2	–	
		I _{OH} = –18 mA; V _I = V _{IH}	2.3	2.3	1.7	–	
3.0	3.0		2.4	–			
V _{OL}	Output LOW Voltage	I _{OL} = 100 μA; V _I = V _{IL}	0.9 – 4.5	0.9 – 4.5	–	0.2	V
		I _{OL} = 0.5 mA; V _I = V _{IH}	1.1	1.1	–	0.3	
		I _{OL} = 2 mA; V _I = V _{IH}	1.4	1.4	–	0.35	
		I _{OL} = 6 mA; V _I = V _{IL}	1.65	1.65	–	0.3	
			2.3	2.3	–	0.4	
		I _{OL} = 12 mA; V _I = V _{IL}	2.7	2.7	–	0.4	
			2.3	2.3	–	0.6	
		I _{OL} = 18 mA; V _I = V _{IL}	3.0	3.0	–	0.4	
3.0	3.0		–	0.55			
I _I	Input Leakage Current	V _I = V _{CCA} or GND	0.9 – 4.5	0.9 – 4.5	–1.0	1.0	μA
I _{CCA}	Quiescent Supply Current	V _I = V _{CCA} or GND; I _O = 0, V _{CCA} = V _{CCB}	0.9 – 4.5	0.9 – 4.5	–	2.0	μA
I _{CCB}	Quiescent Supply Current	V _I = V _{CCA} or GND; I _O = 0, V _{CCA} = V _{CCB}	0.9 – 4.5	0.9 – 4.5	–	2.0	μA
I _{CCA} + I _{CCB}	Quiescent Supply Current	V _I = V _{CCA} or GND; I _O = 0, V _{CCA} = V _{CCB}	0.9 – 4.5	0.9 – 4.5	–	4.0	μA
I _{OFF}	Power OFF Leakage Current	V _I = 4.5 V	0	0	–	5.0	μA

Product parametric performance is indicated in the Electrical Characteristics for the listed test conditions, unless otherwise noted. Product performance may not be indicated by the Electrical Characteristics if operated under different conditions.

NLSV1T34

TOTAL STATIC POWER CONSUMPTION ($I_{CCA} + I_{CCB}$)

V_{CCA} (V)	-40°C to +85°C										Unit
	V_{CCB} (V)										
	4.5		3.3		2.8		1.8		0.9		
	Min	Max	Min	Max	Min	Max	Min	Max	Min	Max	
4.5		2		2		2		2		< 1.5	μ A
3.3		2		2		2		2		< 1.5	μ A
2.8		< 2		< 1		< 1		< 0.5		< 0.5	μ A
1.8		< 1		< 1		< 0.5		< 0.5		< 0.5	μ A
0.9		< 0.5		< 0.5		< 0.5		< 0.5		< 0.5	μ A

NOTE: Connect ground before applying supply voltage V_{CCA} or V_{CCB} . This device is designed with the feature that the power-up sequence of V_{CCA} and V_{CCB} will not damage the IC.

AC ELECTRICAL CHARACTERISTICS

Symbol	Parameter	V_{CCA} (V)	-40°C to +85°C										Unit
			V_{CCB} (V)										
			4.5		3.3		2.8		1.8		1.2		
			Min	Max	Min	Max	Min	Max	Min	Max	Min	Max	
t_{PLH} , t_{PHL} (Note 1)	Propagation Delay, A to B	4.5		1.6		1.8		2.0		2.1		2.3	nS
		3.3		1.7		1.9		2.1		2.3		2.6	
		2.8		1.9		2.1		2.3		2.5		2.8	
		1.8		2.1		2.4		2.5		2.7		3.0	
		1.2		2.4		2.7		2.8		3.0		3.3	

1. Propagation delays defined per Figure 2.

CAPACITANCE

Symbol	Parameter	Test Conditions	Typ (Note 2)	Unit
$C_{I/O}$	I/O Pin Input Capacitance	$V_{CCA} = V_{CCB} = 3.3$ V, $V_I = 0$ V or $V_{CCA/B}$	5.0	pF
C_{PD}	Power Dissipation Capacitance	$V_{CCA} = V_{CCB} = 3.3$ V, $V_I = 0$ V or V_{CCA} , $f = 10$ MHz	5.0	pF

2. Typical values are at $T_A = +25^\circ\text{C}$.

3. C_{PD} is defined as the value of the IC's equivalent capacitance from which the operating current can be calculated from:
 $I_{CC(\text{operating})} \cong C_{PD} \times V_{CC} \times f_{IN}$ where $I_{CC} = I_{CCA} + I_{CCB}$.

NLSV1T34

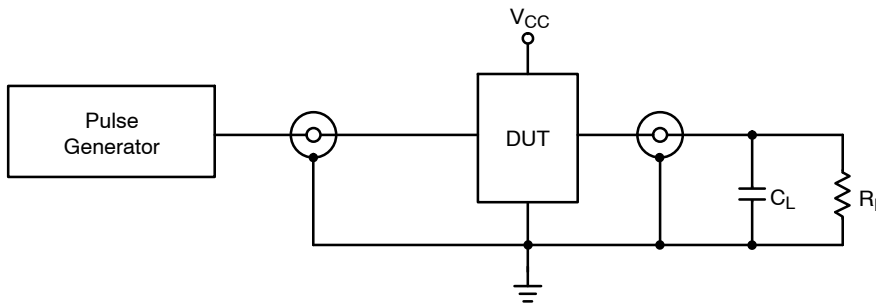
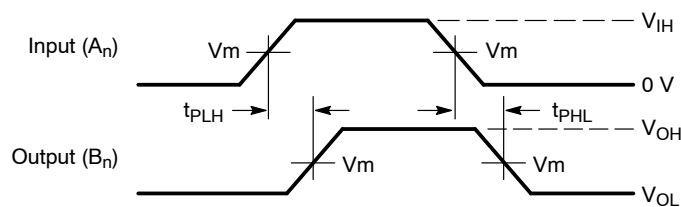

Figure 2. AC (Propagation Delay) Test Circuit

Test	Switch
$C_L = 15 \text{ pF}$ or equivalent (includes probe and jig capacitance)	
$R_L = 2 \text{ k}\Omega$ or equivalent	
Z_{OUT} of pulse generator = 50Ω	



Waveform 1 – Propagation Delays
 $t_R = t_F = 2.0 \text{ ns}$, 10% to 90%; $f = 1 \text{ MHz}$; $t_W = 500 \text{ ns}$

Figure 3. AC (Propagation Delay) Test Circuit Waveforms

Symbol	V_{CC}
	$0.9 \text{ V} - 4.5 \text{ V}$
V_{mA}	$V_{CCA}/2$
V_{mB}	$V_{CCB}/2$

ORDERING INFORMATION

Device	Package	Shipping†
NLSV1T34MUTBG	UDFN6, 1.2 x 1.0, 0.4P (Pb-Free)	3000 / Tape & Reel
NLSV1T34AMUTAG	UDFN6, 1.45 x 1.0, 0.5P (Pb-Free)	3000 / Tape & Reel
NLSV1T34AMUTCG		
NLSV1T34AMX1TCG	ULLGA6 (Pb-Free)	3000 / Tape & Reel
NLSV1T34DFT2G	SC-88A (Pb-Free)	3000 / Tape & Reel
NLVSV1T34DFT2G*		

†For information on tape and reel specifications, including part orientation and tape sizes, please refer to our Tape and Reel Packaging Specifications Brochure, BRD8011/D.

*NLV Prefix for Automotive and Other Applications Requiring Unique Site and Control Change Requirements; AEC-Q100 Qualified and PPAP Capable

NLSV1T34

PACKAGE DIMENSIONS

SC-88A (SC-70-5/SOT-353)
CASE 419A-02
ISSUE L

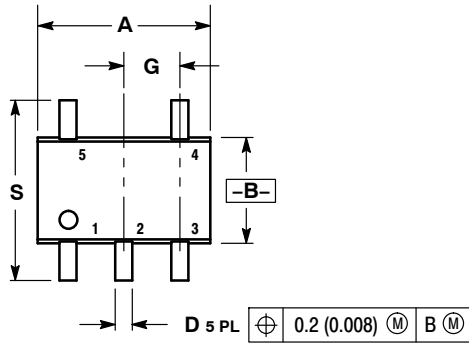

NOTES:

1. DIMENSIONING AND TOLERANCING PER ANSI Y14.5M, 1982.
2. CONTROLLING DIMENSION: INCH.
3. 419A-01 OBSOLETE. NEW STANDARD 419A-02.
4. DIMENSIONS A AND B DO NOT INCLUDE MOLD FLASH, PROTRUSIONS, OR GATE BURRS.

DIM	INCHES		MILLIMETERS	
	MIN	MAX	MIN	MAX
A	0.071	0.087	1.80	2.20
B	0.045	0.053	1.15	1.35
C	0.031	0.043	0.80	1.10
D	0.004	0.012	0.10	0.30
G	0.026 BSC		0.65 BSC	
H	---	0.004	---	0.10
J	0.004	0.010	0.10	0.25
K	0.004	0.012	0.10	0.30
N	0.008 REF		0.20 REF	
S	0.079	0.087	2.00	2.20

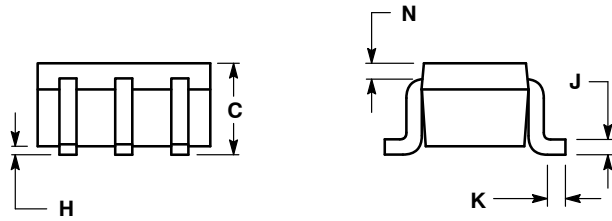

SOLDER FOOTPRINT

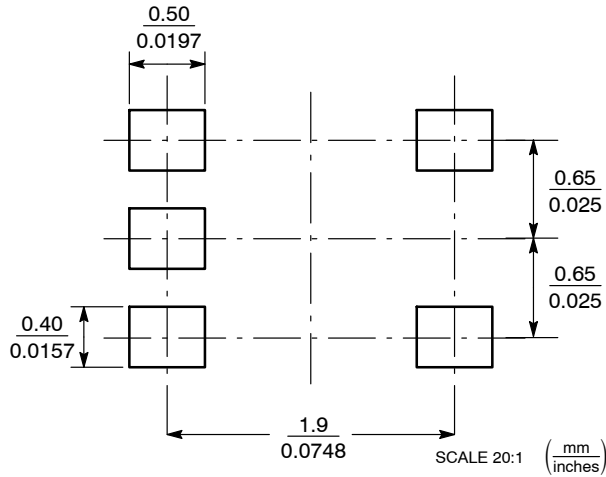

*For additional information on our Pb-Free strategy and soldering details, please download the ON Semiconductor Soldering and Mounting Techniques Reference Manual, SOLDERRM/D.

NLSV1T34

PACKAGE DIMENSIONS

UDFN6, 1.2x1.0, 0.4P
CASE 517AA
ISSUE D

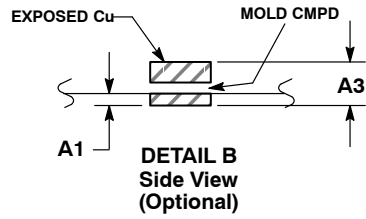
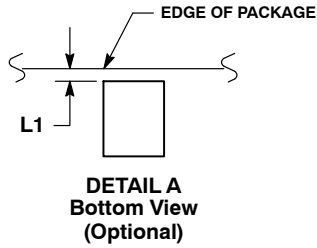
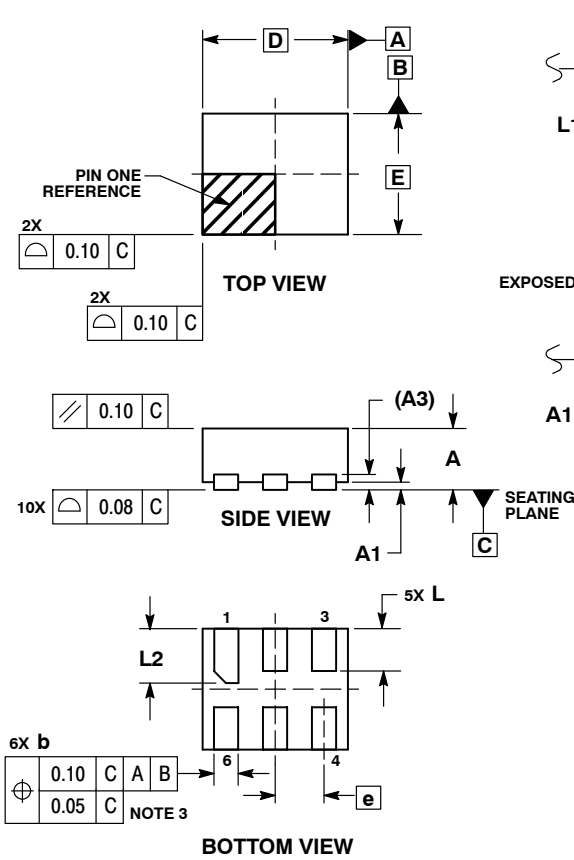

NOTES:

1. DIMENSIONING AND TOLERANCING PER ASME Y14.5M, 1994.
2. CONTROLLING DIMENSION: MILLIMETERS.
3. DIMENSION b APPLIES TO PLATED TERMINAL AND IS MEASURED BETWEEN 0.25 AND 0.30 mm FROM TERMINAL.
4. COPLANARITY APPLIES TO THE EXPOSED PAD AS WELL AS THE TERMINALS.

DIM	MILLIMETERS	
	MIN	MAX
A	0.45	0.55
A1	0.00	0.05
A3	0.127	REF
b	0.15	0.25
D	1.20	BSC
E	1.00	BSC
e	0.40	BSC
L	0.30	0.40
L1	0.00	0.15
L2	0.40	0.50

MOUNTING FOOTPRINT*

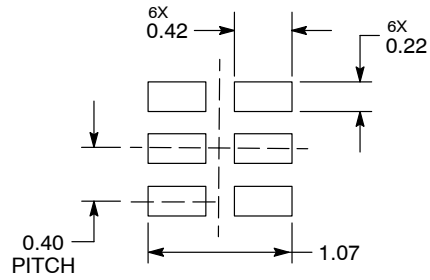

DIMENSIONS: MILLIMETERS

*For additional information on our Pb-Free strategy and soldering details, please download the ON Semiconductor Soldering and Mounting Techniques Reference Manual, SOLDERRM/D.

NLSV1T34

PACKAGE DIMENSIONS

UDFN6, 1.45x1.0, 0.5P
CASE 517AQ
ISSUE O

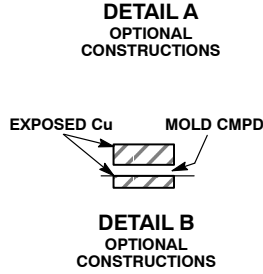
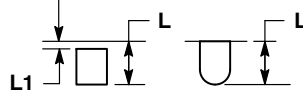
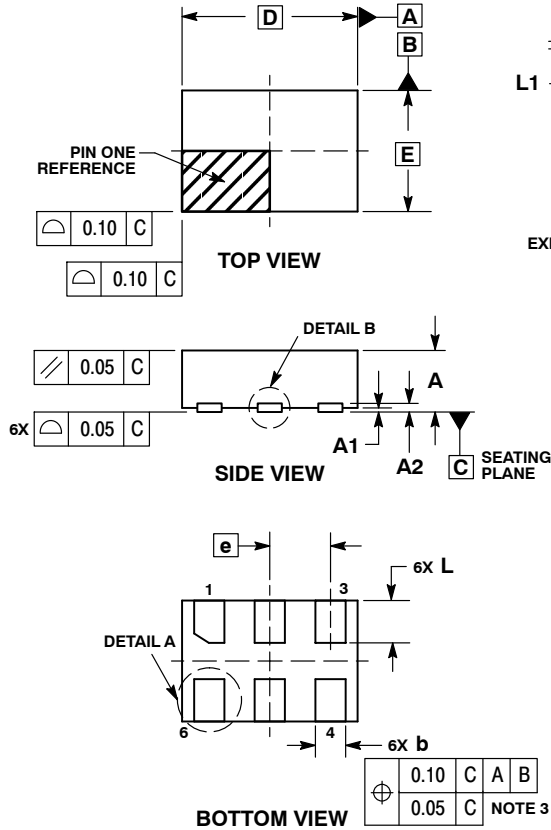

NOTES:

1. DIMENSIONING AND TOLERANCING PER ASME Y14.5M, 1994.
2. CONTROLLING DIMENSION: MILLIMETERS.
3. DIMENSION b APPLIES TO PLATED TERMINAL AND IS MEASURED BETWEEN 0.15 AND 0.30 mm FROM THE TERMINAL TIP.

MILLIMETERS		
DIM	MIN	MAX
A	0.45	0.55
A1	0.00	0.05
A2	0.07 REF	
b	0.20	0.30
D	1.45 BSC	
E	1.00 BSC	
e	0.50 BSC	
L	0.30	0.40
L1	---	0.15

MOUNTING FOOTPRINT

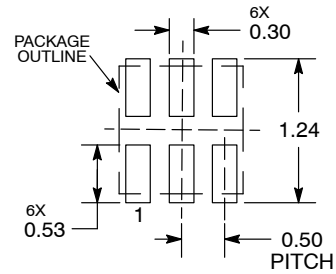

DIMENSIONS: MILLIMETERS

*For additional information on our Pb-Free strategy and soldering details, please download the ON Semiconductor Soldering and Mounting Techniques Reference Manual, SOLDERRM/D.

NLSV1T34

PACKAGE DIMENSIONS

ULLGA6 1.45x1.0, 0.5P
CASE 613AF
ISSUE A

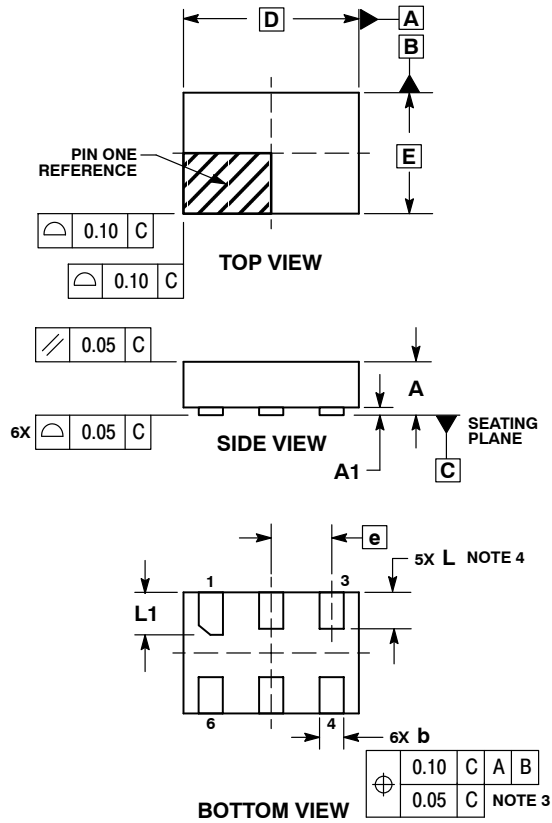

NOTES:

1. DIMENSIONING AND TOLERANCING PER ASME Y14.5M, 1994.
2. CONTROLLING DIMENSION: MILLIMETERS.
3. DIMENSION b APPLIES TO PLATED TERMINAL AND IS MEASURED BETWEEN 0.15 AND 0.30 mm FROM THE TERMINAL TIP.
4. A MAXIMUM OF 0.05 PULL BACK OF THE PLATED TERMINAL FROM THE EDGE OF THE PACKAGE IS ALLOWED.

MILLIMETERS		
DIM	MIN	MAX
A	---	0.40
A1	0.00	0.05
b	0.15	0.25
D	1.45 BSC	
E	1.00 BSC	
e	0.50 BSC	
L	0.25	0.35
L1	0.30	0.40

MOUNTING FOOTPRINT SOLDERMASK DEFINED*

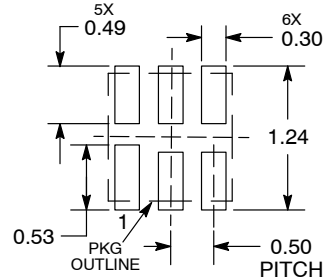

DIMENSIONS: MILLIMETERS

*For additional information on our Pb-Free strategy and soldering details, please download the ON Semiconductor Soldering and Mounting Techniques Reference Manual, SOLDERRM/D.

MiniGate is a trademark of Semiconductor Components Industries, LLC (SCILLC).

ON Semiconductor and are trademarks of Semiconductor Components Industries, LLC dba ON Semiconductor or its subsidiaries in the United States and/or other countries. ON Semiconductor owns the rights to a number of patents, trademarks, copyrights, trade secrets, and other intellectual property. A listing of ON Semiconductor's product/patent coverage may be accessed at www.onsemi.com/site/pdf/Patent-Marking.pdf. ON Semiconductor reserves the right to make changes without further notice to any products herein. ON Semiconductor makes no warranty, representation or guarantee regarding the suitability of its products for any particular purpose, nor does ON Semiconductor assume any liability arising out of the application or use of any product or circuit, and specifically disclaims any and all liability, including without limitation special, consequential or incidental damages. Buyer is responsible for its products and applications using ON Semiconductor products, including compliance with all laws, regulations and safety requirements or standards, regardless of any support or applications information provided by ON Semiconductor. "Typical" parameters which may be provided in ON Semiconductor data sheets and/or specifications can and do vary in different applications and actual performance may vary over time. All operating parameters, including "Typicals" must be validated for each customer application by customer's technical experts. ON Semiconductor does not convey any license under its patent rights nor the rights of others. ON Semiconductor products are not designed, intended, or authorized for use as a critical component in life support systems or any FDA Class 3 medical devices or medical devices with a same or similar classification in a foreign jurisdiction or any devices intended for implantation in the human body. Should Buyer purchase or use ON Semiconductor products for any such unintended or unauthorized application, Buyer shall indemnify and hold ON Semiconductor and its officers, employees, subsidiaries, affiliates, and distributors harmless against all claims, costs, damages, and expenses, and reasonable attorney fees arising out of, directly or indirectly, any claim of personal injury or death associated with such unintended or unauthorized use, even if such claim alleges that ON Semiconductor was negligent regarding the design or manufacture of the part. ON Semiconductor is an Equal Opportunity/Affirmative Action Employer. This literature is subject to all applicable copyright laws and is not for resale in any manner.

PUBLICATION ORDERING INFORMATION

LITERATURE FULFILLMENT:
Email Requests to: orderlit@onsemi.com

TECHNICAL SUPPORT
North American Technical Support:
Voice Mail: 1 800-282-9855 Toll Free USA/Canada
Phone: 011 421 33 790 2910

Europe, Middle East and Africa Technical Support:
Phone: 00421 33 790 2910
For additional information, please contact your local Sales Representative