

NCP5901B

MOSFET Driver, VR12 Compatible, Synchronous Buck

The NCP5901B is a high performance dual MOSFET gate driver optimized to drive the gates of both high-side and low-side power MOSFETs in a synchronous buck converter. It can drive up to 3 nF load with a 25 ns propagation delay and 20 ns transition time.

Adaptive anti-cross-conduction and power saving operation circuit can provide a low switching loss and high efficiency solution for notebook and desktop systems. Bidirectional EN pin can provide a fault signal to controller when the gate driver fault detect under OVP, UVLO occur. Also, an under-voltage lockout function guarantees the outputs are low when supply voltage is low

Features

- Faster Rise and Fall Times
- Adaptive Anti-Cross-Conduction Circuit
- Integrated Bootstrap Diode
- Pre OV function
- ZCD Detect
- Floating Top Driver Accommodates Boost Voltages of up to 35 V
- Output Disable Control Turns Off Both MOSFETs
- Under-voltage Lockout
- Power Saving Operation Under Light Load Conditions
- Direct Interface to NCP6151 and Other Compatible PWM Controllers
- Thermally Enhanced Package
- These are Pb-Free Devices

Typical Applications

- Power Solutions for Desktop Systems



ON Semiconductor®

<http://onsemi.com>



SOIC-8 NB
D SUFFIX
CASE 751

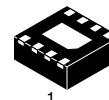

DFN8
MN SUFFIX
CASE 506AA

MARKING DIAGRAMS

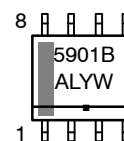

5901B = Specific Device Code
A = Assembly Location
L = Wafer Lot
Y = Year
W = Work Week
▪ = Pb-Free Package

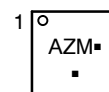

AZ = Specific Device Code
M = Date Code
▪ = Pb-Free Device

ORDERING INFORMATION

Device	Package	Shipping†
NCP5901BMNTBG	DFN8 (Pb-Free)	3000 / Tape & Reel
NCP5901BDR2G	SOIC-8 (Pb-Free)	2500 / Tape & Reel

†For information on tape and reel specifications, including part orientation and tape sizes, please refer to our Tape and Reel Packaging Specification Brochure, BRD8011/D.

NCP5901B

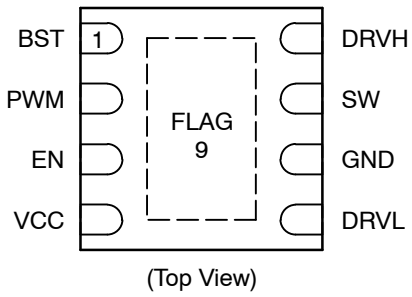

Figure 1. Pin Diagram

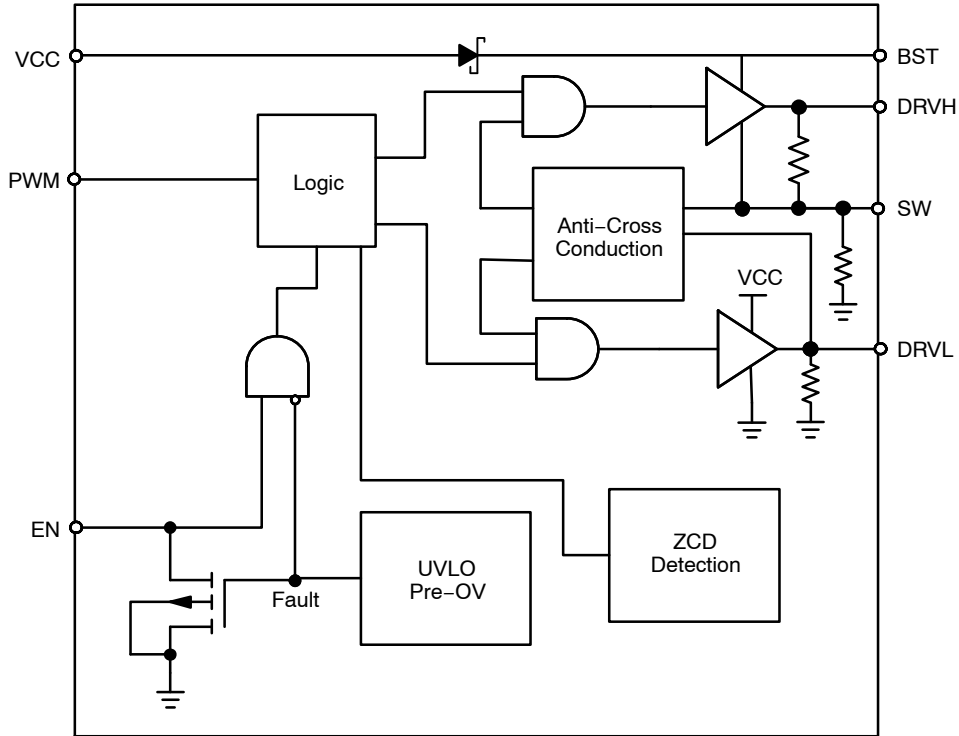

Figure 2. Block Diagram

Table 1. Pin Descriptions

Pin No.	Symbol	Description
1	BST	Floating bootstrap supply pin for high side gate driver. Connect the bootstrap capacitor between this pin and the SW pin.
2	PWM	Control input. The PWM signal has three distinctive states: Low = Low Side FET Enabled, Mid = Diode Emulation Enabled, High = High Side FET Enabled.
3	EN	Logic input. A logic high to enable the part and a logic low to disable the part.
4	VCC	Power supply input. Connect a bypass capacitor (0.1 μ F) from this pin to ground.
5	DRVL	Low side gate drive output. Connect to the gate of low side MOSFET.
6	GND	Bias and reference ground. All signals are referenced to this node (QFN Flag).
7	SW	Switch node. Connect this pin to the source of the high side MOSFET and drain of the low side MOSFET.
8	DRVH	High side gate drive output. Connect to the gate of high side MOSFET.
9	FLAG	Thermal flag. There is no electrical connection to the IC. Connect to ground plane.

NCP5901B

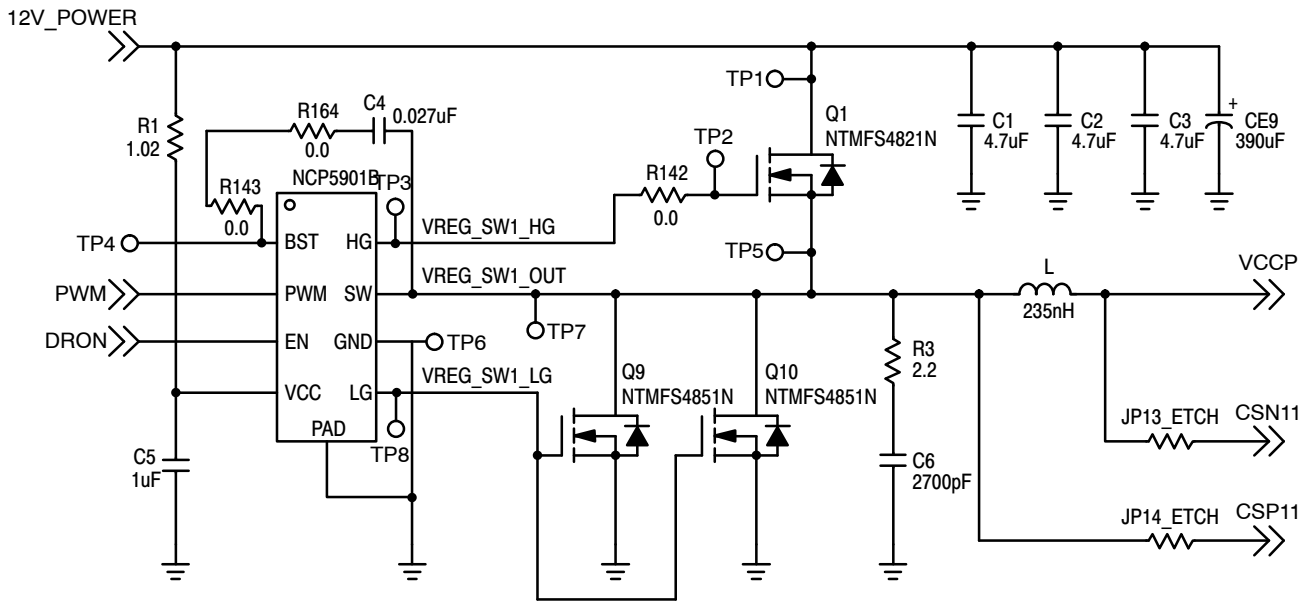

Figure 3. Application Circuit

Table 2. ABSOLUTE MAXIMUM RATINGS

Pin Symbol	Pin Name	V _{MAX}	V _{MIN}
VCC	Main Supply Voltage Input	15 V	-0.3 V
BST	Bootstrap Supply Voltage	35 V wrt/ GND 40 V ≤ 50 ns wrt/ GND 15 V wrt/ SW	-0.3 V wrt/SW
SW	Switching Node (Bootstrap Supply Return)	35 V 40 V ≤ 50 ns	-5 V -10 V (200 ns)
DRVH	High Side Driver Output	BST+0.3 V	-0.3 V wrt/SW -2 V (<200 ns) wrt/SW
DRVL	Low Side Driver Output	VCC+0.3 V	-0.3 V DC -5 V (<200 ns)
PWM	DRVH and DRVL Control Input	6.5 V	-0.3 V
EN	Enable Pin	6.5 V	-0.3 V
GND	Ground	0 V	0 V

Stresses exceeding Maximum Ratings may damage the device. Maximum Ratings are stress ratings only. Functional operation above the Recommended Operating Conditions is not implied. Extended exposure to stresses above the Recommended Operating Conditions may affect device reliability.

Table 3. THERMAL INFORMATION (All signals referenced to AGND unless noted otherwise)

Symbol	Parameter	Value	Unit
R _{θJA}	Thermal Characteristic	SOIC Package (Note 1) 74	°C/W
T _J	Operating Junction Temperature Range (Note 2)	0 to 150	°C
T _A	Operating Ambient Temperature Range	-10 to +125	°C
T _{STG}	Maximum Storage Temperature Range	-55 to +150	°C
MSL	Moisture Sensitivity Level	SOIC Package 1 DFN Package 1	

* The maximum package power dissipation must be observed.

1. 1 in² Cu, 1 oz thickness.

2. Operation at -40°C to -10°C guaranteed by design, not production tested.

NCP5901B

Table 4. ELECTRICAL CHARACTERISTICS (Unless otherwise stated: $-10^{\circ}\text{C} < T_A < +125^{\circ}\text{C}$; $4.5\text{ V} < V_{\text{CC}} < 13.2\text{ V}$, $4.5\text{ V} < \text{BST-SWN} < 13.2\text{ V}$, $4.5\text{ V} < \text{BST} < 30\text{ V}$, $0\text{ V} < \text{SWN} < 21\text{ V}$)

Parameter	Test Conditions	Min.	Typ.	Max.	Units
SUPPLY VOLTAGE					
VCC Operation Voltage		4.5		13.2	V
Power ON Reset Threshold			2.75	3.2	V
UNDERVOLTAGE LOCKOUT					
VCC Start Threshold		3.8	4.35	4.5	V
VCC UVLO Hysteresis		150	200	250	mV
Output Overvoltage Trip Threshold at Startup	Power Startup time, VCC > POR	2.1	2.25	2.4	V
SUPPLY CURRENT					
Normal Mode	$I_{\text{CC}} + I_{\text{BST}}$, EN = 5 V, PWM = OSC, Fsw = 100 KHz, Cload = 3 nF for DRVH, 3 nF for DRVL		12.2		mA
Standby Current	$I_{\text{CC}} + I_{\text{BST}}$, EN = GND		0.5	1.9	mA
Standby Current	$I_{\text{CC}} + I_{\text{BST}}$, EN = HIGH, PWM = LOW, No loading on DRVH & DRVL		2.1		mA
Standby Current	$I_{\text{CC}} + I_{\text{BST}}$, EN = HIGH, PWM = HIGH, No loading on DRVH & DRVL		2.2		mA
BOOTSTRAP DIODE					
Forward Voltage	$V_{\text{CC}} = 12\text{ V}$, forward bias current = 2 mA	0.1	0.4	0.6	V
PWM INPUT					
PWM Input High		3.4			V
PWM Mid-State		1.3		2.7	V
PWM Input Low				0.7	V
ZCD Blanking Timer			250		ns
HIGH SIDE DRIVER (VCC = 12 V)					
Output Impedance, Sourcing Current	VBST - VSW = 12 V		2.0	3.5	Ω
Output Impedance, Sinking Current	VBST - VSW = 12 V		1.0	2.0	Ω
DRVH Rise Time t_{rDRVH}	$V_{\text{VCC}} = 12\text{ V}$, 3 nF load, VBST-VSW = 12 V		16	30	ns
DRVH Fall Time t_{fDRVH}	$V_{\text{VCC}} = 12\text{ V}$, 3 nF load, VBST-VSW = 12 V		11	25	ns
DRVH Turn-Off Propagation Delay t_{pdhDRVH}	$C_{\text{LOAD}} = 3\text{ nF}$	8.0		30	ns
DRVH Turn-On Propagation Delay t_{pdlDRVH}	$C_{\text{LOAD}} = 3\text{ nF}$			30	ns
SW Pull Down Resistance	SW to PGND		45		k Ω
DRVH Pull Down Resistance	DRVH to SW, BST-SW = 0 V		45		k Ω
HIGH SIDE DRIVER (VCC = 5 V)					
Output Impedance, Sourcing Current	VBST - VSW = 5 V		4.5		Ω
Output Impedance, Sinking Current	VBST - VSW = 5 V		2.9		Ω
DRVH Rise Time t_{rDRVH}	$V_{\text{VCC}} = 5\text{ V}$, 3 nF load, VBST - VSW = 5 V		30		ns
DRVH Fall Time t_{fDRVH}	$V_{\text{VCC}} = 5\text{ V}$, 3 nF load, VBST - VSW = 5 V		27		ns
DRVH Turn-Off Propagation Delay t_{pdhDRVH}	$C_{\text{LOAD}} = 3\text{ nF}$		20		ns
DRVH Turn-On Propagation Delay t_{pdlDRVH}	$C_{\text{LOAD}} = 3\text{ nF}$		27		ns
SW Pull Down Resistance	SW to PGND		45		k Ω

NCP5901B

Table 4. ELECTRICAL CHARACTERISTICS (Unless otherwise stated: $-10^{\circ}\text{C} < T_A < +125^{\circ}\text{C}$; $4.5\text{ V} < V_{CC} < 13.2\text{ V}$, $4.5\text{ V} < \text{BST-SWN} < 13.2\text{ V}$, $4.5\text{ V} < \text{BST} < 30\text{ V}$, $0\text{ V} < \text{SWN} < 21\text{ V}$)

Parameter	Test Conditions	Min.	Typ.	Max.	Units
-----------	-----------------	------	------	------	-------

HIGH SIDE DRIVER (VCC = 5 V)

DRVH Pull Down Resistance	DRVH to SW, BST-SW = 0 V		45		k Ω
---------------------------	--------------------------	--	----	--	------------

LOW SIDE DRIVER (VCC = 12 V)

Output Impedance, Sourcing Current			2.0	3.5	Ω
Output Impedance, Sinking Current			0.8	1.8	Ω
DRVL Rise Time t_{rDRVL}	$C_{LOAD} = 3\text{ nF}$		16	35	ns
DRVL Fall Time t_{fDRVL}	$C_{LOAD} = 3\text{ nF}$		11	20	ns
DRVL Turn-Off Propagation Delay t_{pdDRVL}	$C_{LOAD} = 3\text{ nF}$			35	ns
DRVL Turn-On Propagation Delay $t_{pdhDRVL}$	$C_{LOAD} = 3\text{ nF}$	8.0		30	ns
DRVL Pull Down Resistance	DRVL to PGND, VCC = PGND		45		k Ω

LOW SIDE DRIVER (VCC = 5 V)

Output Impedance, Sourcing Current			4.5		Ω
Output Impedance, Sinking Current			2.4		Ω
DRVL Rise Time t_{rDRVL}	$C_{LOAD} = 3\text{ nF}$		30		ns
DRVL Fall Time t_{fDRVL}	$C_{LOAD} = 3\text{ nF}$		22		ns
DRVL Turn-Off Propagation Delay t_{pdDRVL}	$C_{LOAD} = 3\text{ nF}$		27		ns
DRVL Turn-On Propagation Delay $t_{pdhDRVL}$	$C_{LOAD} = 3\text{ nF}$		12		ns
DRVL Pull Down Resistance	DRVL to PGND, VCC = PGND		45		k Ω

EN INPUT

Input Voltage High		2.0			V
Input Voltage Low				1.0	V
Hysteresis			500		mV
Normal Mode Bias Current		-1		1	μA
Enable Pin Sink Current		4		30	mA
Propagation Delay Time			20	40	ns

SW Node

SW Node Leakage Current				20	μA
Zero Cross Detection Threshold Voltage	SW to -20 mV, ramp slowly until BG goes off (Start in DCM mode) (Note 3)		-6		mV

Table 5. DECODER TRUTH TABLE

PWM INPUT	ZCD	DRVL	DRVH
PWM High	ZCD Reset	Low	High
PWM Mid	Positive current through the inductor	High	Low
PWM Mid	Zero current through the inductor	Low	Low
PWM Low	ZCD Reset	High	Low

3. Guaranteed by design; not production tested.

NCP5901B



Figure 4.

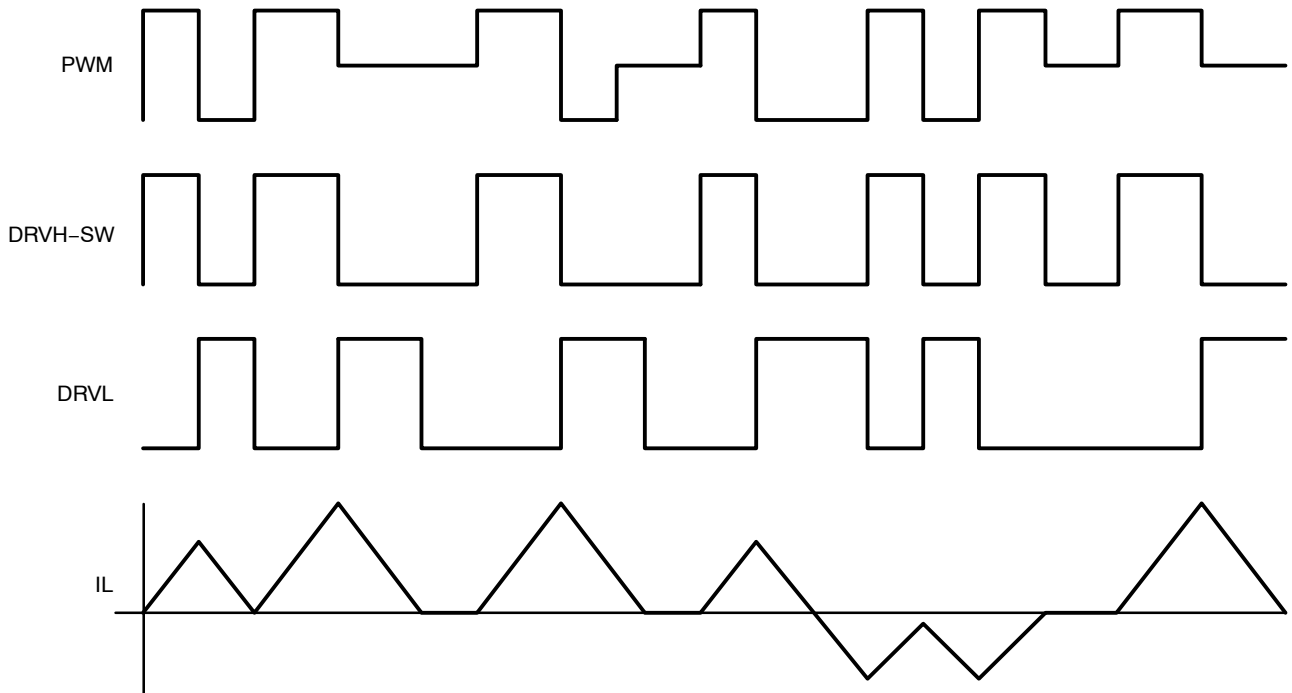

Figure 5. Timing Diagram

APPLICATIONS INFORMATION

The NCP5901B gate driver is a single phase MOSFET driver designed for driving N-channel MOSFETs in a synchronous buck converter topology. The NCP5901B is designed to work with ON Semiconductor's NCP6131 multi-phase controller. This gate driver is optimized for desktop applications.

Undervoltage Lockout

The DRVH and DRVL are held low until VCC reaches 4.5 V during startup. The PWM signals will control the gate status when VCC threshold is exceeded. If VCC decreases to 250 mV below the threshold, the output gate will be forced low until input voltage VCC rises above the startup threshold.

Power-On Reset

Power-On Reset feature is used to protect a gate driver avoid abnormal status driving the startup condition. When the initial soft-start voltage is higher than 2.75 V, the gate driver will monitor the switching node SW pin. If SW pin high than 2.25 V, bottom gate will be force to high for discharge the output capacitor. The fault mode will be latch and EN pin will force to be low, unless the driver is recycle. When input voltage is higher than 4.5 V, and EN goes high, the gate driver will normal operation, top gate driver DRVH and bottom gate driver will follow the PWM signal decode to a status.

Bi-directional EN Signal

Fault modes such as Power-On Reset and Undervoltage Lockout will de-assert the EN pin, which will pull down the DRON pin of controller as well. Thus the controller will be shut down consequently.

PWM Input and Zero Cross Detect (ZCD)

The PWM input, along with EN and ZCD, control the state of DRVH and DRVL.

When PWM is set high, DRVH will be set high after the adaptive non-overlap delay. When PWM is set low, DRVL will be set high after the adaptive non-overlap delay.

When the PWM is set to the mid state, DRVH will be set low, and after the adaptive non-overlap delay, DRVL will be set high. DRVL remains high during the ZCD blanking time. When the timer is expired, the SW pin will be monitored for zero cross detection. After the detection, the DRVL will be set low.

Adaptive Nonoverlap

The nonoverlap dead time control is used to avoid the shoot through damage the power MOSFETs. When the PWM signal pull high, DRVL will go low after a propagation delay, the controller will monitors the switching node (SWN) pin voltage and the gate voltage of the MOSFET to know the status of the MOSFET. When the low side MOSFET status is off an internal timer will delay

turn on of the high-side MOSFET. When the PWM pull low, gate DRVH will go low after the propagation delay ($t_{pd\ DRVH}$).

The time to turn off the high side MOSFET is depending on the total gate charge of the high-side MOSFET. A timer will be triggered once the high side MOSFET is turn off to delay the turn on the low-side MOSFET.

Low-Side Driver Timeout

In normal operation, the DRVH signal tracks the PWM signal and turns off the Q1 high-side switch with a few 10 ns delay ($t_{pdIDRVH}$) following the falling edge of the input signal. When Q1 is turned off, DRVL is allowed to go high, Q2 turns on, and the SW node voltage collapses to zero. But in a fault condition such as a high-side Q1 switch drain-source short circuit, the SW node cannot fall to zero, even when DRVH goes low. This driver has a timer circuit to address this scenario. Every time the PWM goes low, a DRVL on-time delay timer is triggered.

If the SW node voltage does not trigger a low-side turn-on, the DRVL on-time delay circuit does it instead, when it times out with $t_{SW(TO)}$ delay. If Q1 is still turned on, that is, its drain is shorted to the source, Q2 turns on and creates a direct short circuit across the VDCIN voltage rail. The crowbar action causes the fuse in the VDCIN current path to open. The opening of the fuse saves the load (CPU) from potential damage that the high-side switch short circuit could have caused.

Layout Guidelines

Layout for DC-DC converter is very important. The bootstrap and VCC bypass capacitors should be placed as close as to the driver IC.

Connect GND pin to local ground plane. The ground plane can provide a good return path for gate drives and reduce the ground noise. The thermal slug should be tied to the ground plane for good heat dissipation. To minimize the ground loop for low side MOSFET, the driver GND pin should be close to the low-side MOSFET source pin. The gate drive trace should be routed to minimize the length, the minimum width is 20 mils.

Gate Driver Power Loss Calculation

The gate driver power loss consists of the gate drive loss and quiescent power loss.

The equation below can be used to calculate the power dissipation of the gate driver. Where Q_{GMF} is the total gate charge for each main MOSFET and Q_{GSF} is the total gate charge for each synchronous MOSFET.

$$P_{DRV} = \left[\frac{f_{sw}}{2 \times n} \times (n_{MF} \times Q_{GMF} + n_{SF} \times Q_{GSF}) + I_{CC} \right] \times V_{CC}$$

Also shown is the standby dissipation factor ($I_{CC} \cdot V_{CC}$) of the driver.

MECHANICAL CASE OUTLINE

PACKAGE DIMENSIONS

ON Semiconductor®

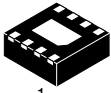

SCALE 4:1

DFN8 2x2, 0.5P
CASE 506AA-01
ISSUE E

DATE 22 JAN 2010

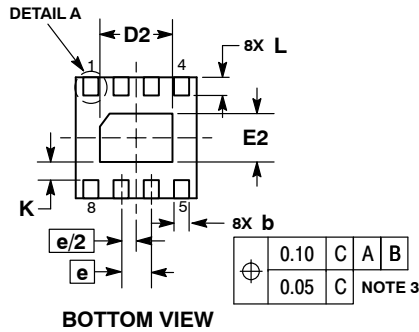
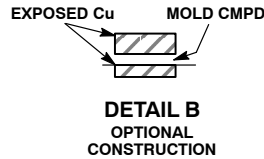
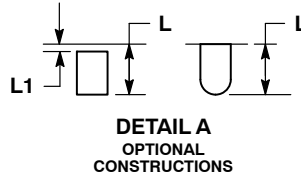
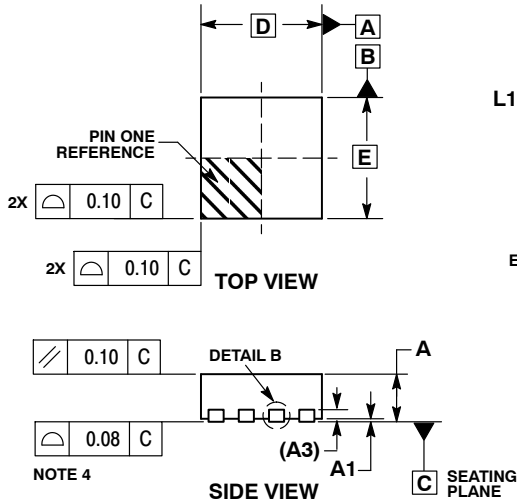

NOTES:

1. DIMENSIONING AND TOLERANCING PER ASME Y14.5M, 1994.
2. CONTROLLING DIMENSION: MILLIMETERS.
3. DIMENSION b APPLIES TO PLATED TERMINAL AND IS MEASURED BETWEEN 0.15 AND 0.20 MM FROM TERMINAL TIP.
4. COPLANARITY APPLIES TO THE EXPOSED PAD AS WELL AS THE TERMINALS.

MILLIMETERS		
DIM	MIN	MAX
A	0.80	1.00
A1	0.00	0.05
A3	0.20	REF
b	0.20	0.30
D	2.00	BSC
D2	1.10	1.30
E	2.00	BSC
E2	0.70	0.90
e	0.50	BSC
K	0.30	REF
L	0.25	0.35
L1	---	0.10

GENERIC MARKING DIAGRAM*

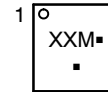

- XX = Specific Device Code
- M = Date Code
- = Pb-Free Device

*This information is generic. Please refer to device data sheet for actual part marking. Pb-Free indicator, "G" or microdot "■", may or may not be present.

RECOMMENDED SOLDERING FOOTPRINT*

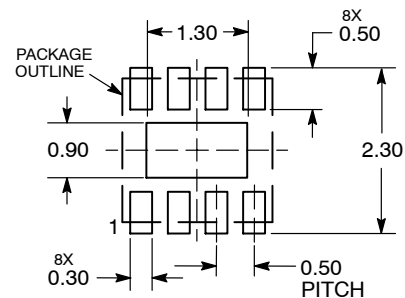

DIMENSIONS: MILLIMETERS

*For additional information on our Pb-Free strategy and soldering details, please download the ON Semiconductor Soldering and Mounting Techniques Reference Manual, SOLDERRM/D.

DOCUMENT NUMBER:	98AON18658D	Electronic versions are uncontrolled except when accessed directly from the Document Repository. Printed versions are uncontrolled except when stamped "CONTROLLED COPY" in red.
DESCRIPTION:	DFN8, 2.0X2.0, 0.5MM PITCH	PAGE 1 OF 1

ON Semiconductor and are trademarks of Semiconductor Components Industries, LLC dba ON Semiconductor or its subsidiaries in the United States and/or other countries. ON Semiconductor reserves the right to make changes without further notice to any products herein. ON Semiconductor makes no warranty, representation or guarantee regarding the suitability of its products for any particular purpose, nor does ON Semiconductor assume any liability arising out of the application or use of any product or circuit, and specifically disclaims any and all liability, including without limitation special, consequential or incidental damages. ON Semiconductor does not convey any license under its patent rights nor the rights of others.

MECHANICAL CASE OUTLINE PACKAGE DIMENSIONS

ON Semiconductor®



SCALE 1:1

SOIC-8 NB
CASE 751-07
ISSUE AK

DATE 16 FEB 2011



- NOTES:
1. DIMENSIONING AND TOLERANCING PER ANSI Y14.5M, 1982.
 2. CONTROLLING DIMENSION: MILLIMETER.
 3. DIMENSION A AND B DO NOT INCLUDE MOLD PROTRUSION.
 4. MAXIMUM MOLD PROTRUSION 0.15 (0.006) PER SIDE.
 5. DIMENSION D DOES NOT INCLUDE DAMBAR PROTRUSION. ALLOWABLE DAMBAR PROTRUSION SHALL BE 0.127 (0.005) TOTAL IN EXCESS OF THE D DIMENSION AT MAXIMUM MATERIAL CONDITION.
 6. 751-01 THRU 751-06 ARE OBSOLETE. NEW STANDARD IS 751-07.

DIM	MILLIMETERS		INCHES	
	MIN	MAX	MIN	MAX
A	4.80	5.00	0.189	0.197
B	3.80	4.00	0.150	0.157
C	1.35	1.75	0.053	0.069
D	0.33	0.51	0.013	0.020
G	1.27 BSC		0.050 BSC	
H	0.10	0.25	0.004	0.010
J	0.19	0.25	0.007	0.010
K	0.40	1.27	0.016	0.050
M	0°	8°	0°	8°
N	0.25	0.50	0.010	0.020
S	5.80	6.20	0.228	0.244

SOLDERING FOOTPRINT*



*For additional information on our Pb-Free strategy and soldering details, please download the ON Semiconductor Soldering and Mounting Techniques Reference Manual, SOLDERRM/D.

GENERIC MARKING DIAGRAM*



XXXXXX = Specific Device Code
A = Assembly Location
L = Wafer Lot
Y = Year
W = Work Week
▪ = Pb-Free Package

XXXXXX = Specific Device Code
A = Assembly Location
Y = Year
WW = Work Week
▪ = Pb-Free Package

*This information is generic. Please refer to device data sheet for actual part marking. Pb-Free indicator, "G" or microdot "▪", may or may not be present. Some products may not follow the Generic Marking.

STYLES ON PAGE 2

DOCUMENT NUMBER:	98ASB42564B	Electronic versions are uncontrolled except when accessed directly from the Document Repository. Printed versions are uncontrolled except when stamped "CONTROLLED COPY" in red.
DESCRIPTION:	SOIC-8 NB	PAGE 1 OF 2

ON Semiconductor and ON are trademarks of Semiconductor Components Industries, LLC dba ON Semiconductor or its subsidiaries in the United States and/or other countries. ON Semiconductor reserves the right to make changes without further notice to any products herein. ON Semiconductor makes no warranty, representation or guarantee regarding the suitability of its products for any particular purpose, nor does ON Semiconductor assume any liability arising out of the application or use of any product or circuit, and specifically disclaims any and all liability, including without limitation special, consequential or incidental damages. ON Semiconductor does not convey any license under its patent rights nor the rights of others.

SOIC-8 NB
CASE 751-07
ISSUE AK

DATE 16 FEB 2011

- | | | | |
|--|---|---|---|
| <p>STYLE 1:
 PIN 1. EMITTER
 2. COLLECTOR
 3. COLLECTOR
 4. EMITTER
 5. EMITTER
 6. BASE
 7. BASE
 8. EMITTER</p> | <p>STYLE 2:
 PIN 1. COLLECTOR, DIE, #1
 2. COLLECTOR, #1
 3. COLLECTOR, #2
 4. COLLECTOR, #2
 5. BASE, #2
 6. EMITTER, #2
 7. BASE, #1
 8. EMITTER, #1</p> | <p>STYLE 3:
 PIN 1. DRAIN, DIE #1
 2. DRAIN, #1
 3. DRAIN, #2
 4. DRAIN, #2
 5. GATE, #2
 6. SOURCE, #2
 7. GATE, #1
 8. SOURCE, #1</p> | <p>STYLE 4:
 PIN 1. ANODE
 2. ANODE
 3. ANODE
 4. ANODE
 5. ANODE
 6. ANODE
 7. ANODE
 8. COMMON CATHODE</p> |
| <p>STYLE 5:
 PIN 1. DRAIN
 2. DRAIN
 3. DRAIN
 4. DRAIN
 5. GATE
 6. GATE
 7. SOURCE
 8. SOURCE</p> | <p>STYLE 6:
 PIN 1. SOURCE
 2. DRAIN
 3. DRAIN
 4. SOURCE
 5. SOURCE
 6. GATE
 7. GATE
 8. SOURCE</p> | <p>STYLE 7:
 PIN 1. INPUT
 2. EXTERNAL BYPASS
 3. THIRD STAGE SOURCE
 4. GROUND
 5. DRAIN
 6. GATE 3
 7. SECOND STAGE Vd
 8. FIRST STAGE Vd</p> | <p>STYLE 8:
 PIN 1. COLLECTOR, DIE #1
 2. BASE, #1
 3. BASE, #2
 4. COLLECTOR, #2
 5. COLLECTOR, #2
 6. EMITTER, #2
 7. EMITTER, #1
 8. COLLECTOR, #1</p> |
| <p>STYLE 9:
 PIN 1. EMITTER, COMMON
 2. COLLECTOR, DIE #1
 3. COLLECTOR, DIE #2
 4. EMITTER, COMMON
 5. EMITTER, COMMON
 6. BASE, DIE #2
 7. BASE, DIE #1
 8. EMITTER, COMMON</p> | <p>STYLE 10:
 PIN 1. GROUND
 2. BIAS 1
 3. OUTPUT
 4. GROUND
 5. GROUND
 6. BIAS 2
 7. INPUT
 8. GROUND</p> | <p>STYLE 11:
 PIN 1. SOURCE 1
 2. GATE 1
 3. SOURCE 2
 4. GATE 2
 5. DRAIN 2
 6. DRAIN 2
 7. DRAIN 1
 8. DRAIN 1</p> | <p>STYLE 12:
 PIN 1. SOURCE
 2. SOURCE
 3. SOURCE
 4. GATE
 5. DRAIN
 6. DRAIN
 7. DRAIN
 8. DRAIN</p> |
| <p>STYLE 13:
 PIN 1. N.C.
 2. SOURCE
 3. SOURCE
 4. GATE
 5. DRAIN
 6. DRAIN
 7. DRAIN
 8. DRAIN</p> | <p>STYLE 14:
 PIN 1. N-SOURCE
 2. N-GATE
 3. P-SOURCE
 4. P-GATE
 5. P-DRAIN
 6. P-DRAIN
 7. N-DRAIN
 8. N-DRAIN</p> | <p>STYLE 15:
 PIN 1. ANODE 1
 2. ANODE 1
 3. ANODE 1
 4. ANODE 1
 5. CATHODE, COMMON
 6. CATHODE, COMMON
 7. CATHODE, COMMON
 8. CATHODE, COMMON</p> | <p>STYLE 16:
 PIN 1. EMITTER, DIE #1
 2. BASE, DIE #1
 3. EMITTER, DIE #2
 4. BASE, DIE #2
 5. COLLECTOR, DIE #2
 6. COLLECTOR, DIE #2
 7. COLLECTOR, DIE #1
 8. COLLECTOR, DIE #1</p> |
| <p>STYLE 17:
 PIN 1. VCC
 2. V2OUT
 3. V1OUT
 4. TXE
 5. RXE
 6. VEE
 7. GND
 8. ACC</p> | <p>STYLE 18:
 PIN 1. ANODE
 2. ANODE
 3. SOURCE
 4. GATE
 5. DRAIN
 6. DRAIN
 7. CATHODE
 8. CATHODE</p> | <p>STYLE 19:
 PIN 1. SOURCE 1
 2. GATE 1
 3. SOURCE 2
 4. GATE 2
 5. DRAIN 2
 6. MIRROR 2
 7. DRAIN 1
 8. MIRROR 1</p> | <p>STYLE 20:
 PIN 1. SOURCE (N)
 2. GATE (N)
 3. SOURCE (P)
 4. GATE (P)
 5. DRAIN
 6. DRAIN
 7. DRAIN
 8. DRAIN</p> |
| <p>STYLE 21:
 PIN 1. CATHODE 1
 2. CATHODE 2
 3. CATHODE 3
 4. CATHODE 4
 5. CATHODE 5
 6. COMMON ANODE
 7. COMMON ANODE
 8. CATHODE 6</p> | <p>STYLE 22:
 PIN 1. I/O LINE 1
 2. COMMON CATHODE/VCC
 3. COMMON CATHODE/VCC
 4. I/O LINE 3
 5. COMMON ANODE/GND
 6. I/O LINE 4
 7. I/O LINE 5
 8. COMMON ANODE/GND</p> | <p>STYLE 23:
 PIN 1. LINE 1 IN
 2. COMMON ANODE/GND
 3. COMMON ANODE/GND
 4. LINE 2 IN
 5. LINE 2 OUT
 6. COMMON ANODE/GND
 7. COMMON ANODE/GND
 8. LINE 1 OUT</p> | <p>STYLE 24:
 PIN 1. BASE
 2. EMITTER
 3. COLLECTOR/ANODE
 4. COLLECTOR/ANODE
 5. CATHODE
 6. CATHODE
 7. COLLECTOR/ANODE
 8. COLLECTOR/ANODE</p> |
| <p>STYLE 25:
 PIN 1. VIN
 2. N/C
 3. REXT
 4. GND
 5. IOUT
 6. IOUT
 7. IOUT
 8. IOUT</p> | <p>STYLE 26:
 PIN 1. GND
 2. dv/dt
 3. ENABLE
 4. ILIMIT
 5. SOURCE
 6. SOURCE
 7. SOURCE
 8. VCC</p> | <p>STYLE 27:
 PIN 1. ILIMIT
 2. OVLO
 3. UVLO
 4. INPUT+
 5. SOURCE
 6. SOURCE
 7. SOURCE
 8. DRAIN</p> | <p>STYLE 28:
 PIN 1. SW_TO_GND
 2. DASIC OFF
 3. DASIC_SW_DET
 4. GND
 5. V_MON
 6. VBULK
 7. VBULK
 8. VIN</p> |
| <p>STYLE 29:
 PIN 1. BASE, DIE #1
 2. EMITTER, #1
 3. BASE, #2
 4. EMITTER, #2
 5. COLLECTOR, #2
 6. COLLECTOR, #2
 7. COLLECTOR, #1
 8. COLLECTOR, #1</p> | <p>STYLE 30:
 PIN 1. DRAIN 1
 2. DRAIN 1
 3. GATE 2
 4. SOURCE 2
 5. SOURCE 1/DRAIN 2
 6. SOURCE 1/DRAIN 2
 7. SOURCE 1/DRAIN 2
 8. GATE 1</p> | | |

DOCUMENT NUMBER:	98ASB42564B	Electronic versions are uncontrolled except when accessed directly from the Document Repository. Printed versions are uncontrolled except when stamped "CONTROLLED COPY" in red.
DESCRIPTION:	SOIC-8 NB	PAGE 2 OF 2

ON Semiconductor and  are trademarks of Semiconductor Components Industries, LLC dba ON Semiconductor or its subsidiaries in the United States and/or other countries. ON Semiconductor reserves the right to make changes without further notice to any products herein. ON Semiconductor makes no warranty, representation or guarantee regarding the suitability of its products for any particular purpose, nor does ON Semiconductor assume any liability arising out of the application or use of any product or circuit, and specifically disclaims any and all liability, including without limitation special, consequential or incidental damages. ON Semiconductor does not convey any license under its patent rights nor the rights of others.

ON Semiconductor and  are trademarks of Semiconductor Components Industries, LLC dba ON Semiconductor or its subsidiaries in the United States and/or other countries. ON Semiconductor owns the rights to a number of patents, trademarks, copyrights, trade secrets, and other intellectual property. A listing of ON Semiconductor's product/patent coverage may be accessed at www.onsemi.com/site/pdf/Patent-Marking.pdf. ON Semiconductor reserves the right to make changes without further notice to any products herein. ON Semiconductor makes no warranty, representation or guarantee regarding the suitability of its products for any particular purpose, nor does ON Semiconductor assume any liability arising out of the application or use of any product or circuit, and specifically disclaims any and all liability, including without limitation special, consequential or incidental damages. Buyer is responsible for its products and applications using ON Semiconductor products, including compliance with all laws, regulations and safety requirements or standards, regardless of any support or applications information provided by ON Semiconductor. "Typical" parameters which may be provided in ON Semiconductor data sheets and/or specifications can and do vary in different applications and actual performance may vary over time. All operating parameters, including "Typicals" must be validated for each customer application by customer's technical experts. ON Semiconductor does not convey any license under its patent rights nor the rights of others. ON Semiconductor products are not designed, intended, or authorized for use as a critical component in life support systems or any FDA Class 3 medical devices or medical devices with a same or similar classification in a foreign jurisdiction or any devices intended for implantation in the human body. Should Buyer purchase or use ON Semiconductor products for any such unintended or unauthorized application, Buyer shall indemnify and hold ON Semiconductor and its officers, employees, subsidiaries, affiliates, and distributors harmless against all claims, costs, damages, and expenses, and reasonable attorney fees arising out of, directly or indirectly, any claim of personal injury or death associated with such unintended or unauthorized use, even if such claim alleges that ON Semiconductor was negligent regarding the design or manufacture of the part. ON Semiconductor is an Equal Opportunity/Affirmative Action Employer. This literature is subject to all applicable copyright laws and is not for resale in any manner.

PUBLICATION ORDERING INFORMATION

LITERATURE FULFILLMENT:

Email Requests to: orderlit@onsemi.com

ON Semiconductor Website: www.onsemi.com

TECHNICAL SUPPORT

North American Technical Support:
Voice Mail: 1 800-282-9855 Toll Free USA/Canada
Phone: 011 421 33 790 2910

Europe, Middle East and Africa Technical Support:

Phone: 00421 33 790 2910

For additional information, please contact your local Sales Representative