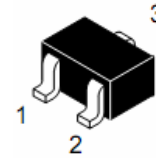
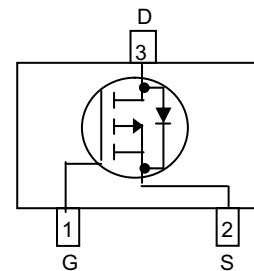
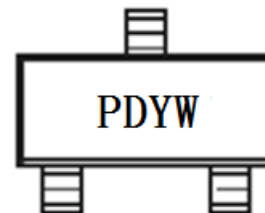

WPM2080
Single P-Channel, -20V, -4.0A, Power MOSFET
[Http://www.sh-willsemi.com](http://www.sh-willsemi.com)

V_{DS} (V)	Typical $R_{DS(on)}$ (m Ω)
-20	43 @ $V_{GS}=-4.5V$
	55 @ $V_{GS}=-2.5V$
	81 @ $V_{GS}=-1.8V$

SOT-23-3L

Pin configuration (Top view)

PD = Device Code
 Y = Year
 W = Week(A~z)

Marking
Descriptions

The WPM2080 is P-Channel enhancement MOS Field Effect Transistor. Uses advanced trench technology and design to provide excellent $R_{DS(ON)}$ with low gate charge. This device is suitable for use in DC-DC conversion, power switch and charging circuit. Standard Product WPM2080 is Pb-free.

Features

- Trench Technology
- Supper high density cell design
- Excellent ON resistance
- Extremely Low Threshold Voltage
- Small package SOT-23-3L

Applications

- DC/DC converters
- Power supply converters circuit
- Load/Power Switching for portable device

Order information

Device	Package	Shipping
WPM2080-3/TR	SOT-23-3L	3000/Tape&Reel

Absolute Maximum ratings

Parameter	Symbol	10 s	Steady State	Unit	
Drain-Source Voltage	V_{DS}	-20		V	
Gate-Source Voltage	V_{GS}	±12			
Continuous Drain Current ^{a d}	I_D	$T_A=25^{\circ}C$	-4.0	-3.4	A
		$T_A=70^{\circ}C$	-3.2	-2.7	
Maximum Power Dissipation ^{a d}	P_D	$T_A=25^{\circ}C$	1.4	1.0	W
		$T_A=70^{\circ}C$	0.9	0.6	
Continuous Drain Current ^{b d}	I_D	$T_A=25^{\circ}C$	-3.5	-3.2	A
		$T_A=70^{\circ}C$	-2.8	-2.6	
Maximum Power Dissipation ^{b d}	P_D	$T_A=25^{\circ}C$	1.1	0.9	W
		$T_A=70^{\circ}C$	0.7	0.6	
Pulsed Drain Current ^c	I_{DM}	-20		A	
Operating Junction Temperature	T_J	-55 to 150		°C	
Lead Temperature	T_L	260		°C	
Storage Temperature Range	T_{stg}	-55 to 150		°C	

Thermal resistance ratings

Single Operation					
Parameter	Symbol	Typical	Maximum	Unit	
Junction-to-Ambient Thermal Resistance ^a	$R_{\theta JA}$	$t \leq 10$ s	70	90	°C/W
		Steady State	90	125	
Junction-to-Ambient Thermal Resistance ^b	$R_{\theta JA}$	$t \leq 10$ s	89	115	
		Steady State	115	140	
Junction-to-Case Thermal Resistance	$R_{\theta JC}$	40	60		

a Surface mounted on FR4 Board using 1 square inch pad size, 1oz copper

b Surface mounted on FR4 board using minimum pad size, 1oz copper

c Repetitive rating, pulse width limited by junction temperature, $t_p=10\mu s$, Duty Cycle=1%

d Repetitive rating, pulse width limited by junction temperature $T_J=150^{\circ}C$.

Electronics Characteristics (Ta=25°C, unless otherwise noted)

Parameter	Symbol	Test Conditions	Min	Typ	Max	Unit
OFF CHARACTERISTICS						
Drain-to-Source Breakdown Voltage	BV_{DSS}	$V_{GS} = 0\text{ V}, I_D = -250\mu\text{A}$	-20			V
Zero Gate Voltage Drain Current	I_{DSS}	$V_{DS} = -16\text{ V}, V_{GS} = 0\text{ V}$			-1	μA
Gate-to-source Leakage Current	I_{GSS}	$V_{DS} = 0\text{ V}, V_{GS} = \pm 12\text{ V}$			± 100	nA
ON CHARACTERISTICS						
Gate Threshold Voltage	$V_{GS(TH)}$	$V_{GS} = V_{DS}, I_D = -250\mu\text{A}$	-0.35	-0.65	-1	V
Drain-to-source On-resistance	$R_{DS(on)}$	$V_{GS} = -4.5\text{ V}, I_D = -4.0\text{ A}$		43	57	m Ω
		$V_{GS} = -2.5\text{ V}, I_D = -3.0\text{ A}$		55	70	
		$V_{GS} = -1.8\text{ V}, I_D = -2.5\text{ A}$		81	120	
Forward Transconductance	g_{FS}	$V_{DS} = -5\text{ V}, I_D = -4\text{ A}$		6	16	S
CHARGES, CAPACITANCES AND GATE RESISTANCE						
Input Capacitance	C_{ISS}	$V_{GS} = 0\text{ V}, f = 1.0\text{ MHz}, V_{DS} = -6\text{ V}$		1062		pF
Output Capacitance	C_{OSS}			146		
Reverse Transfer Capacitance	C_{RSS}			124		
Total Gate Charge	$Q_{G(TOT)}$	$V_{GS} = -4.5\text{ V}, V_{DS} = -10\text{ V}, I_D = -3.3\text{ A}$		10		nC
Threshold Gate Charge	$Q_{G(TH)}$			0.8		
Gate-to-Source Charge	Q_{GS}			1.8		
Gate-to-Drain Charge	Q_{GD}			1.7		
SWITCHING CHARACTERISTICS						
Turn-On Delay Time	$t_d(ON)$	$V_{GS} = -4.5\text{ V}, V_{DS} = -6\text{ V}, I_D = -3.3\text{ A}, R_G = 6\Omega$		11.4		ns
Rise Time	t_r			6.8		
Turn-Off Delay Time	$t_d(OFF)$			67.6		
Fall Time	t_f			16.8		
BODY DIODE CHARACTERISTICS						
Forward Voltage	V_{SD}	$V_{GS} = 0\text{ V}, I_S = -2.5\text{ A}$		-0.8	-1.5	V

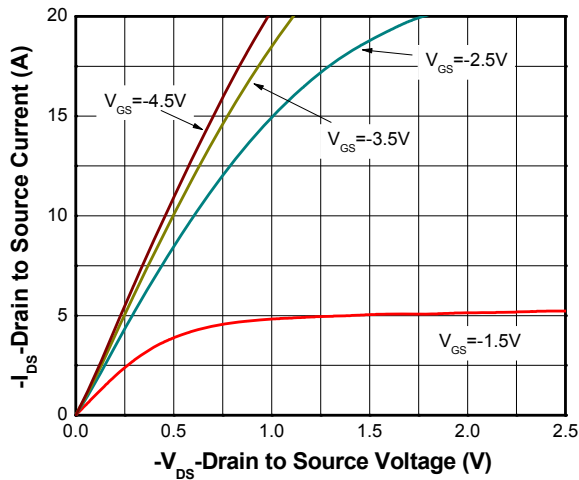
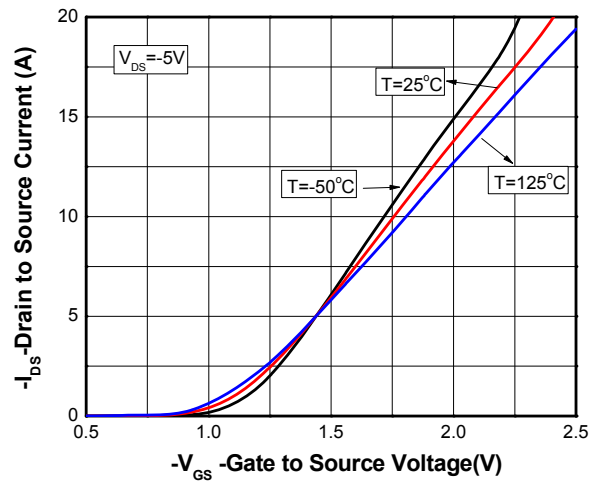
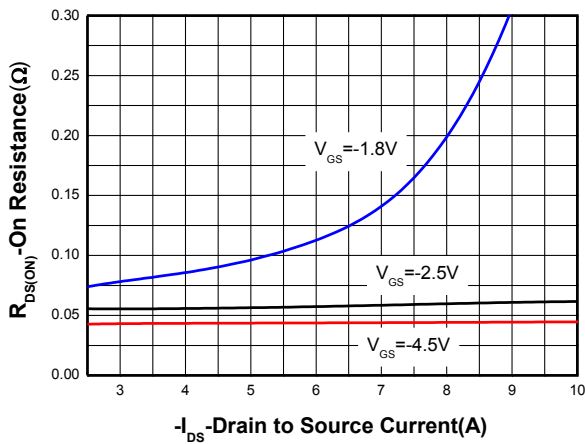
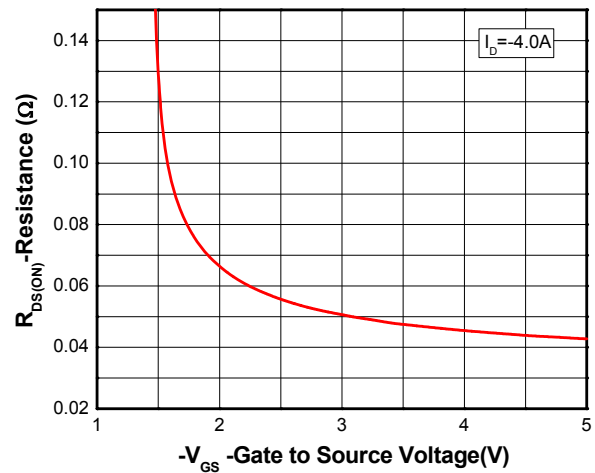
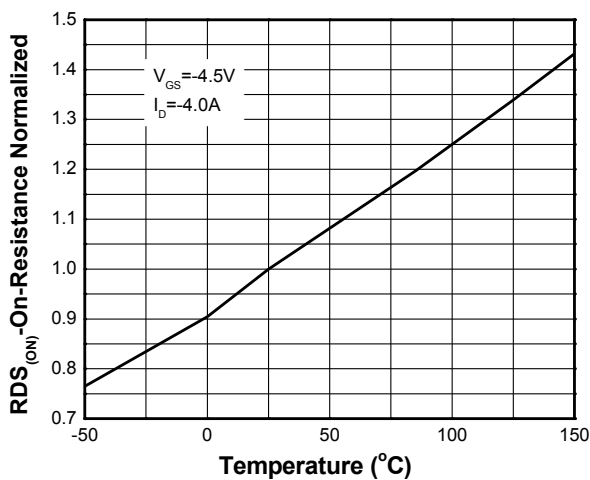
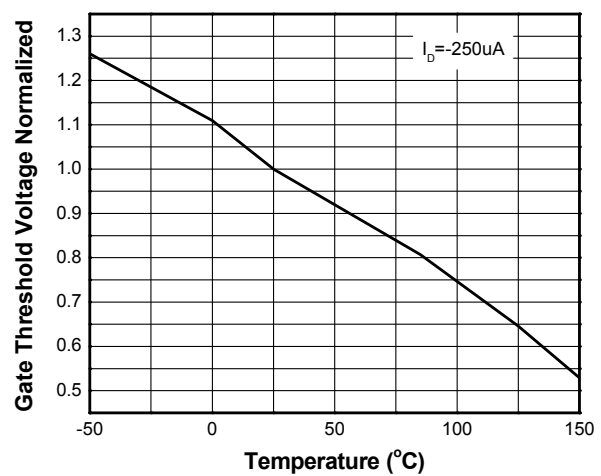
Typical Characteristics (Ta=25°C, unless otherwise noted)

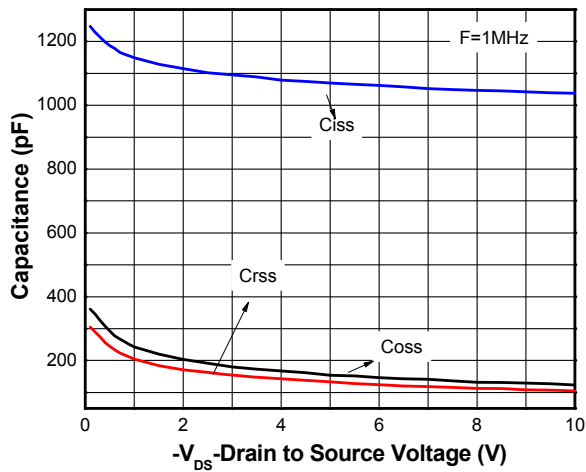
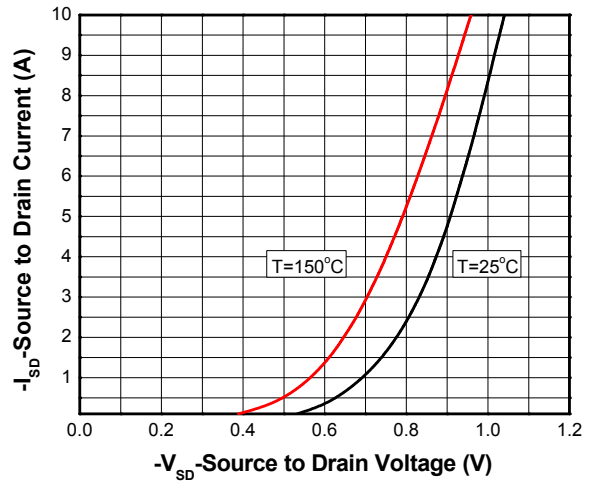
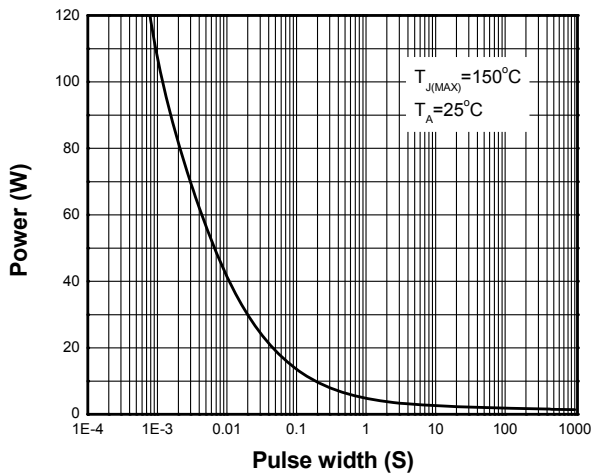
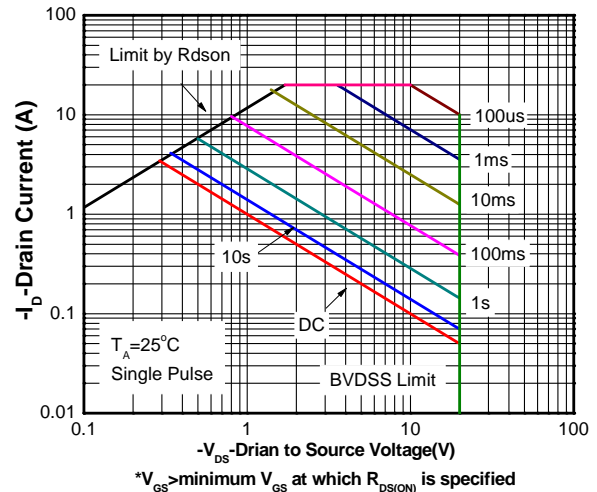
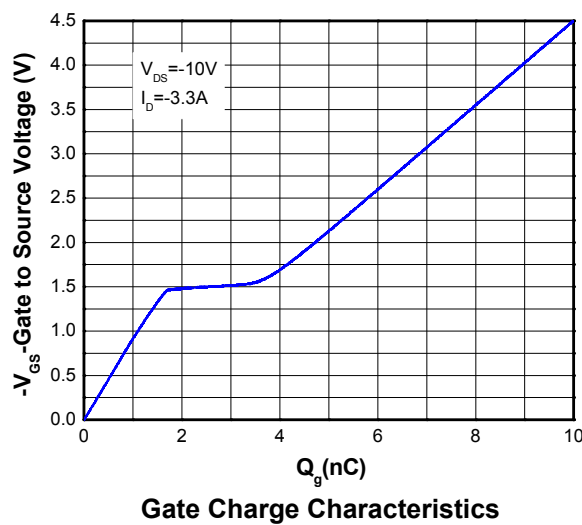
Output characteristics

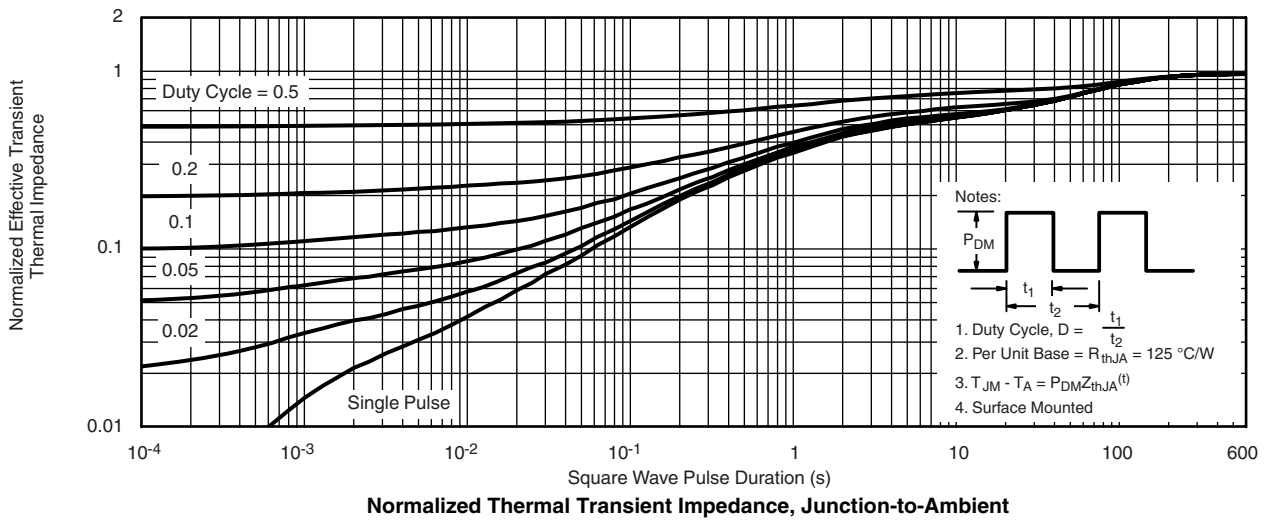
Transfer characteristics

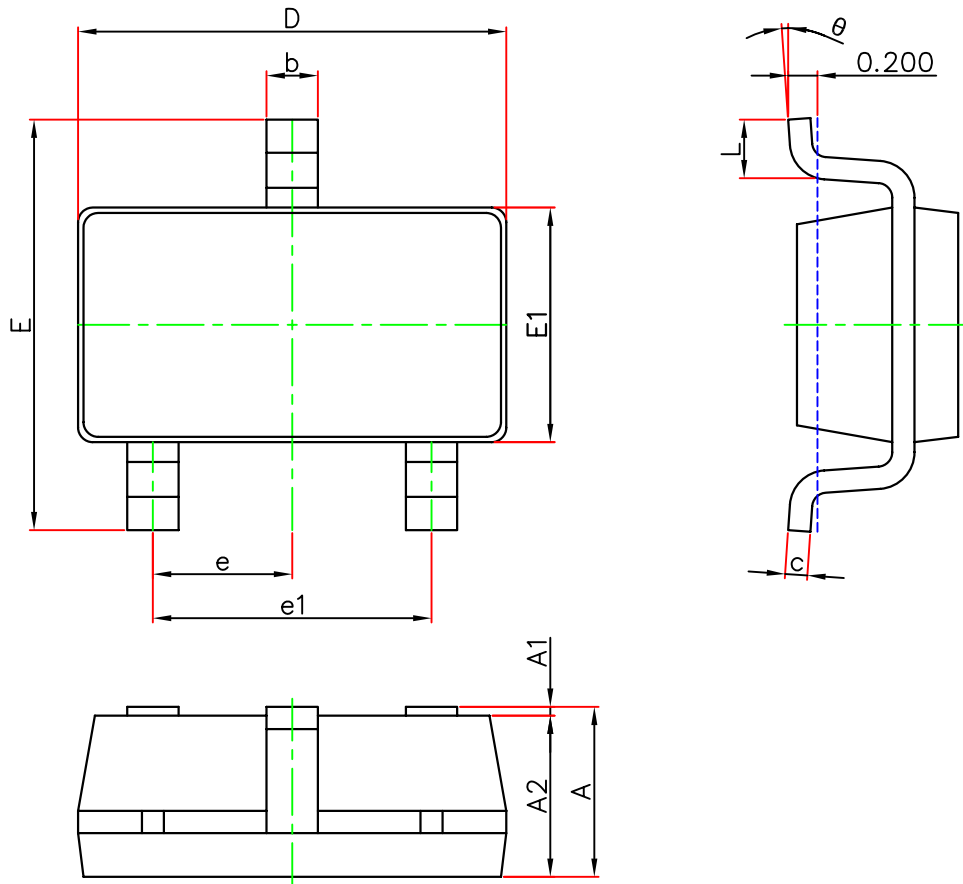
On-Resistance vs. Drain current

On-Resistance vs. Gate-to-source voltage

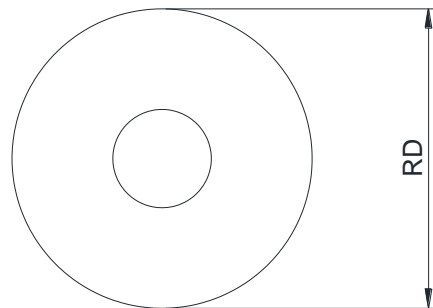
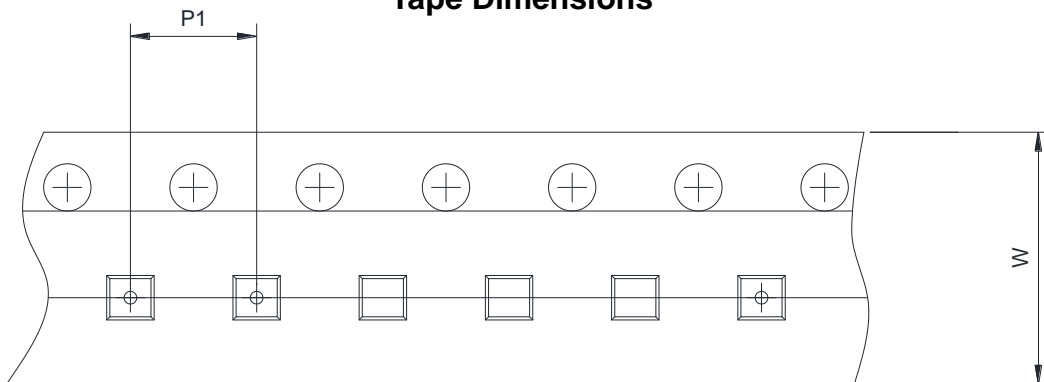
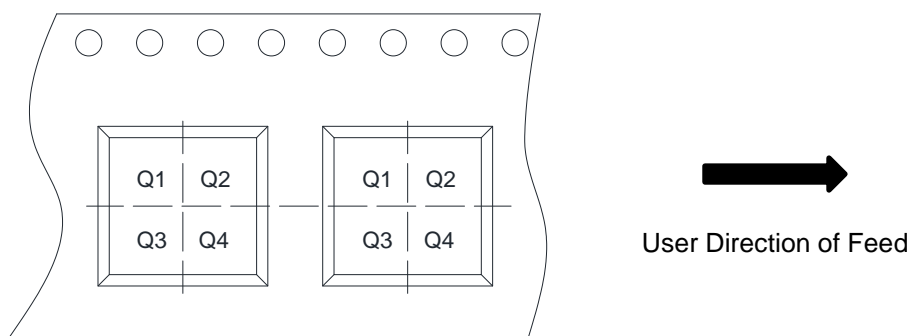
On-Resistance vs. Junction temperature

Threshold voltage vs. Temperature

Capacitance

Body diode forward voltage

Single pulse power

Safe operating power

Gate Charge Characteristics

Transient thermal response (Junction-to-Ambient)

Package outline dimensions
SOT-23-3L

Symbol	Dimensions in Millimeters		
	Min.	Typ.	Max.
A	-	-	1.250
A1	0.000	-	0.150
A2	1.000	1.100	1.200
b	0.300	-	0.500
c	0.140	-	0.200
D	2.820	-	3.026
E	2.600	2.800	3.000
E1	1.500	-	1.726
e	0.950 BSC		
e1	1.800	1.900	2.000
L	0.300	0.450	0.600
θ	0 °	-	8 °

TAPE AND REEL INFORMATION
Reel Dimensions

Tape Dimensions

Quadrant Assignments For PIN1 Orientation In Tape

RD	Reel Dimension	<input checked="" type="checkbox"/> 7inch	<input type="checkbox"/> 13inch
W	Overall width of the carrier tape	<input checked="" type="checkbox"/> 8mm	<input type="checkbox"/> 12mm <input type="checkbox"/> 16mm
P1	Pitch between successive cavity centers	<input type="checkbox"/> 2mm	<input checked="" type="checkbox"/> 4mm <input type="checkbox"/> 8mm
Pin1	Pin1 Quadrant	<input type="checkbox"/> Q1	<input type="checkbox"/> Q2 <input checked="" type="checkbox"/> Q3 <input type="checkbox"/> Q4