

**ESD5325E**
**4-Lines, Uni-directional, Low Capacitance  
Transient Voltage Suppressors**
<http://www.sh-willsemi.com>
**Descriptions**

The ESD5325E is a low capacitance TVS (Transient Voltage Suppressor) array designed to protect high speed data interfaces. It has been specifically designed to protect sensitive electronic components which are connected to data and transmission lines from over-stress caused by ESD (Electrostatic Discharge).

The ESD5325E incorporates four pairs of low capacitance steering diodes plus a TVS diode.

The ESD5325E may be used to provide ESD protection up to  $\pm 30\text{kV}$  (contact discharge) according to IEC61000-4-2, and withstand peak pulse current up to 6A (8/20 $\mu\text{s}$ ) according to IEC61000-4-5.

The ESD5325E is available in SOT23-6L package. Standard products are Pb-free and Halogen-free.

**Features**

- Reverse stand-off voltage: 6V max. (VDD to GND)
- Transient protection for each line according to IEC61000-4-2 (ESD):  $\pm 30\text{kV}$  (contact discharge)  
IEC61000-4-5 (surge): 6A (8/20 $\mu\text{s}$ )
- Low capacitance:  $C_{\text{I/O-GND}} = 1.0\text{pF typ.}$
- Ultra-low leakage current:  $I_{\text{R}} < 1\text{nA typ.}$
- Low clamping voltage:  $V_{\text{CL I/O-GND}} = 12.5\text{V @ } I_{\text{PP}} = 16\text{A}$  (TLP)
- Solid-state silicon technology

**Applications**

- USB 2.0
- Video Graphics Cards
- DVI
- IEEE 1394
- Monitors and Flat Panel Displays
- 10/100 Ethernet
- Notebooks

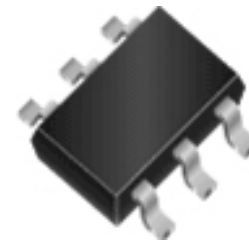
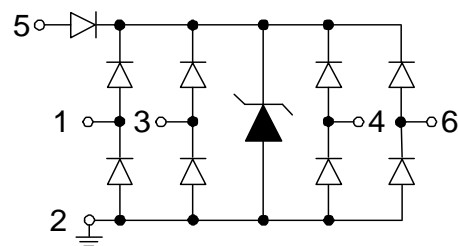
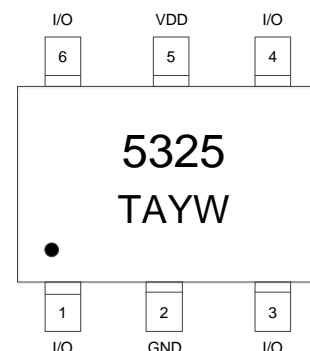
**SOT23-6L**

**Circuit diagram**

5325 = Device code  
TA = Special code  
YW = Date code

**Marking & Pin configuration (Top View)**
**Order information**

Device	Package	Shipping
ESD5325E-6/TR	SOT23-6L	3000/Tape&Reel

**Absolute maximum ratings**

Parameter	Symbol	Rating	Unit
Peak pulse power ( $t_p = 8/20\mu s$ )	$P_{pk}$	70	W
Peak pulse current ( $t_p = 8/20\mu s$ )	$I_{PP}$	6	A
Operating Supply Voltage (VDD to GND)	$V_{DC}$	6	V
ESD according to IEC61000-4-2 air discharge(I/O pins)	$V_{ESD}$	$\pm 30$	kV
ESD according to IEC61000-4-2 contact discharge(I/O pins)		$\pm 30$	
Junction temperature	$T_J$	125	$^{\circ}C$
Operation temperature	$T_{OP}$	-40 to 85	$^{\circ}C$
Storage temperature	$T_{STG}$	-55 to 150	$^{\circ}C$
Lead temperature	$T_L$	260	$^{\circ}C$

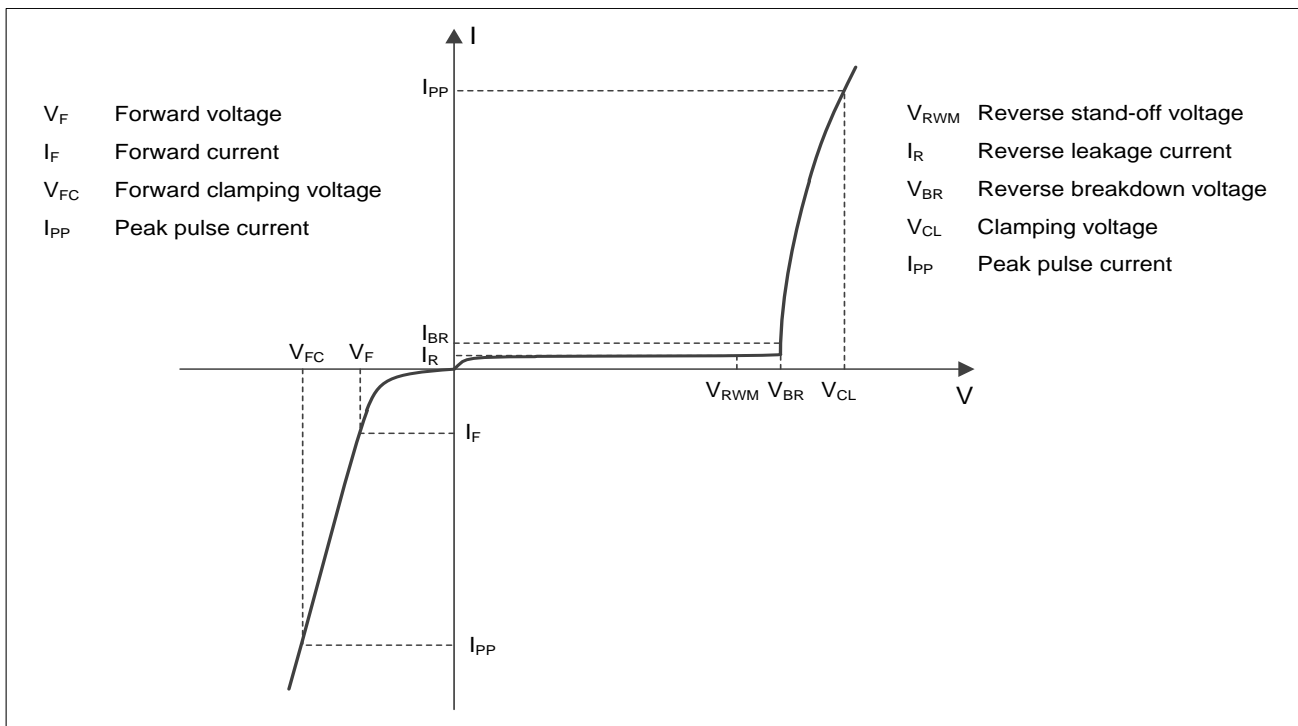
**Electrical characteristics ( $T_A = 25^{\circ}C$ , unless otherwise noted)**

**Definitions of electrical characteristics**

**Electrical characteristics ( $T_A = 25^\circ\text{C}$ , unless otherwise noted)**

Parameter	Symbol	Condition	Min.	Typ.	Max.	Unit
<b>I/O Pins</b>						
Reverse stand-off voltage	$V_{RWM}$				5.0	V
Reverse leakage current	$I_R$	$V_{RWM} = 5V$		<1	100	nA
Reverse breakdown voltage	$V_{BR}$	$I_{BR} = 1\text{mA}$	7.0	8.0	9.0	V
Forward voltage	$V_F$	$I_F = 10\text{mA}$	0.6	0.9	1.2	V
Clamping voltage <sup>1)</sup>	$V_{CL}$	$I_{PP} = 16\text{A}$ , $t_p = 100\text{ns}$		12.5		V
Dynamic resistance <sup>1)</sup>	$R_{DYN}$	$t_p = 100\text{ns}$		0.24		$\Omega$
Clamping voltage <sup>2)</sup>	$V_{CL}$	$V_{ESD} = 8\text{kV}$		12.5		V
Clamping voltage <sup>3)</sup>	$V_{CL}$	$I_{PP} = 1\text{A}$ , $t_p = 8/20\mu\text{s}$		8.5		V
		$I_{PP} = 6\text{A}$ , $t_p = 8/20\mu\text{s}$		11.5		V
Junction capacitance	$C_{I/O-GND}$	$V_R = 0V$ , $f = 1\text{MHz}$ , Any I/O to GND		1.0	1.6	pF
	$C_{I/O-I/O}$	$V_R = 0V$ , $f = 1\text{MHz}$ , Any I/O to I/O		0.50	0.80	pF
<b>VDD Pin</b>						
Reverse stand-off voltage	$V_{RWM}$				6	V
Reverse leakage current	$I_R$	$V_{RWM} = 6V$			1	$\mu\text{A}$
Reverse breakdown voltage	$V_{BR}$	$I_{BR} = 1\text{mA}$	7.0	8.0	9.0	V
Forward voltage	$V_F$	$I_F = 10\text{mA}$	0.6	0.9	1.2	V
Clamping voltage <sup>1)</sup>	$V_{CL}$	$I_{PP} = 16\text{A}$ , $t_p = 100\text{ns}$		12.0		V
Dynamic resistance <sup>1)</sup>	$R_{DYN}$	$t_p = 100\text{ns}$		0.21		$\Omega$
Clamping voltage <sup>2)</sup>	$V_{CL}$	$V_{ESD} = 8\text{kV}$		12.0		V
Clamping voltage <sup>3)</sup>	$V_{CL}$	$I_{PP} = 1\text{A}$ , $t_p = 8/20\mu\text{s}$		8.5		V
		$I_{PP} = 6\text{A}$ , $t_p = 8/20\mu\text{s}$		11.0		V

**Notes:**

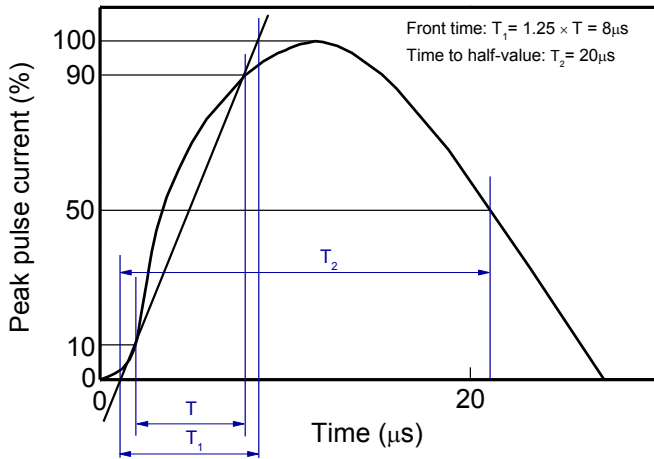
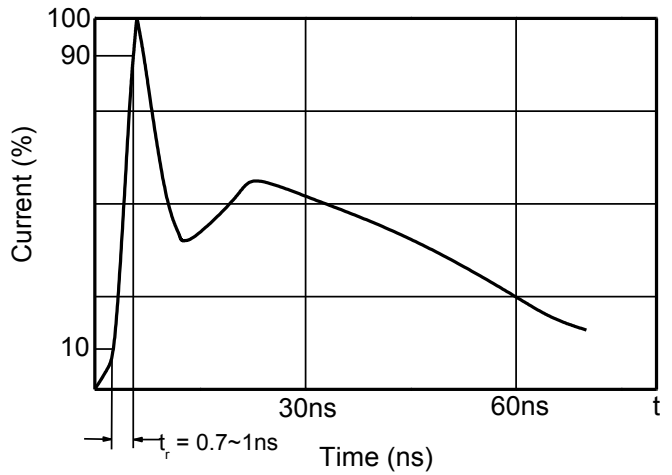
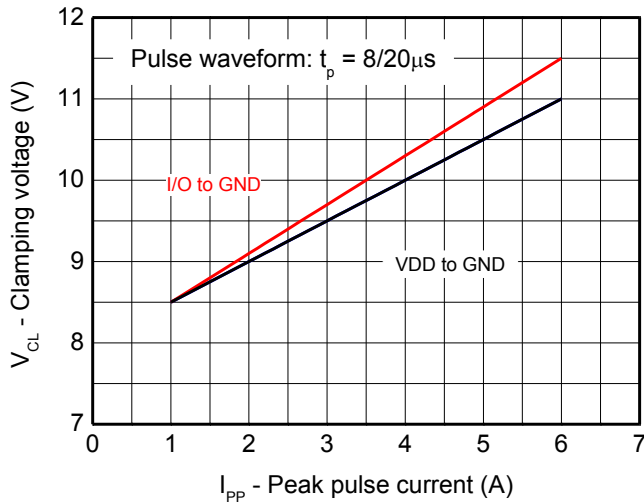
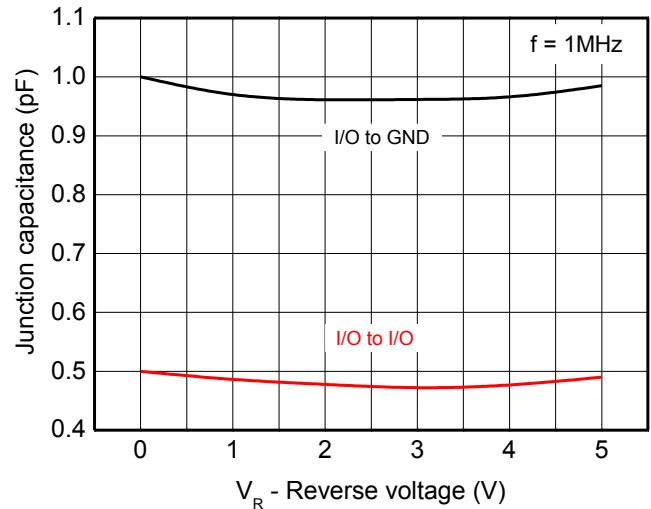
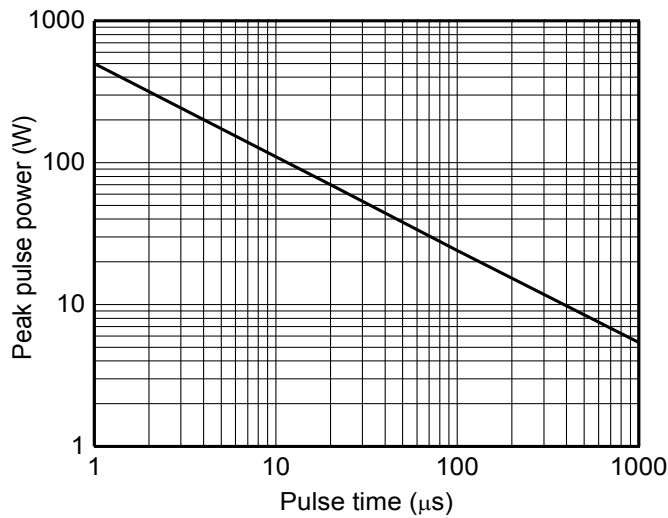
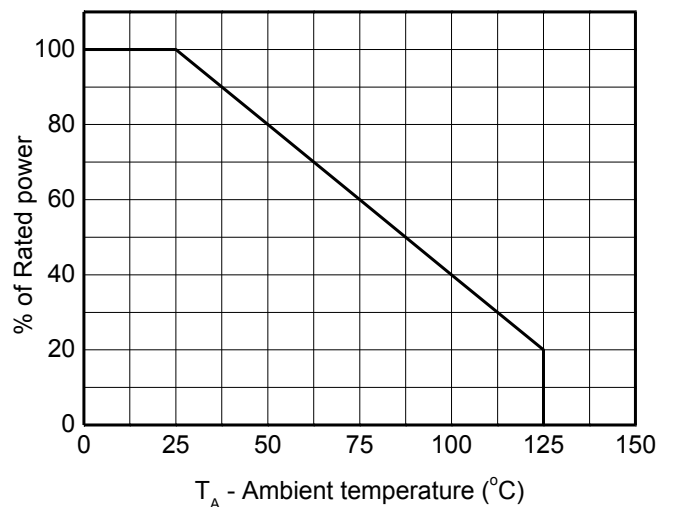
- 1) TLP parameter:  $Z_0 = 50\Omega$ ,  $t_p = 100\text{ns}$ ,  $t_r = 2\text{ns}$ , averaging window from 60ns to 80ns.  $R_{DYN}$  is calculated from 4A to 16A.
- 2) Contact discharge mode, according to IEC61000-4-2.
- 3) Non-repetitive current pulse, according to IEC61000-4-5.

**Typical characteristics ( $T_A = 25^\circ\text{C}$ , unless otherwise noted)**

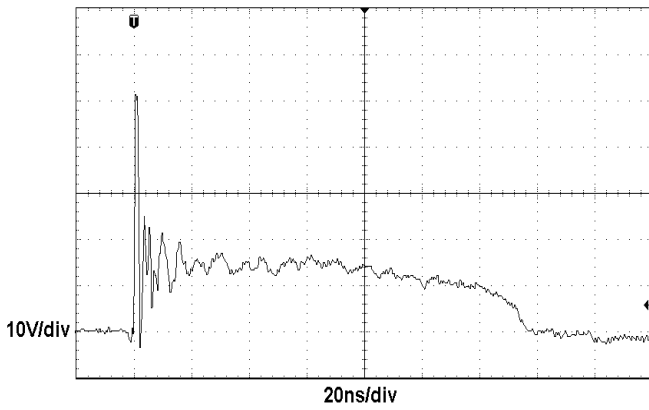
**8/20μs waveform per IEC61000-4-5**

**Contact discharge current waveform per IEC61000-4-2**

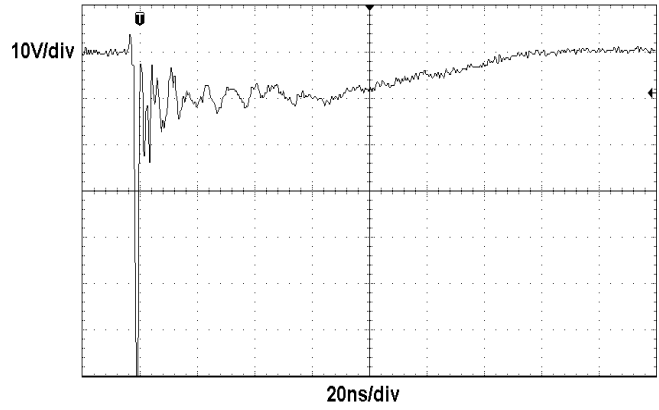
**Clamping voltage vs. Peak pulse current**

**Capacitance vs. Reverse voltage**

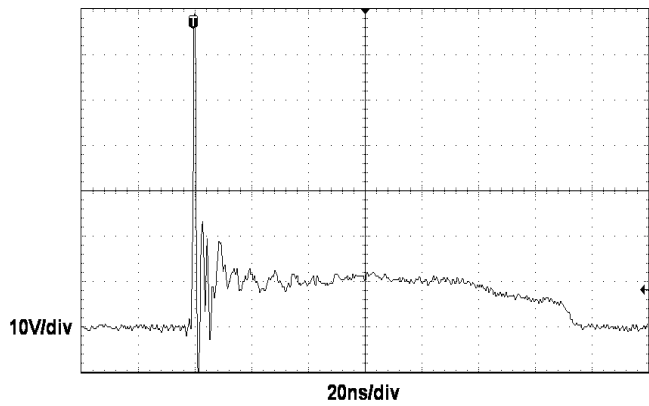
**Non-repetitive peak pulse power vs. Pulse time**

**Power derating vs. Ambient temperature**

**Typical characteristics ( $T_A = 25^\circ\text{C}$ , unless otherwise noted)**

**ESD clamping - I/O to GND**  
 (+8kV contact discharge per IEC61000-4-2)



**ESD clamping - I/O to GND**  
 (-8kV contact discharge per IEC61000-4-2)



**ESD clamping - VDD to GND**  
 (+8kV contact discharge per IEC61000-4-2)

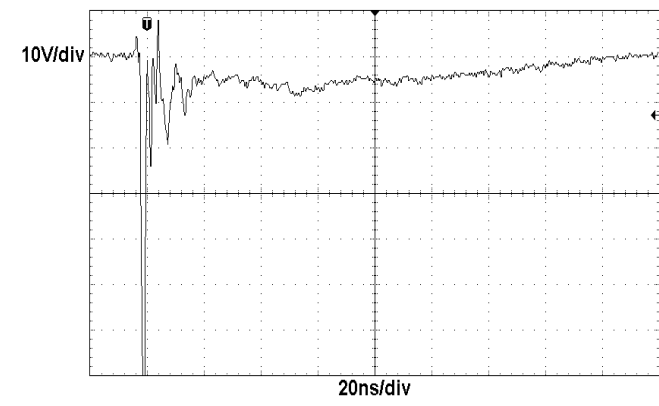

**ESD clamping - VDD to GND**  
 (-8kV contact discharge per IEC61000-4-2)

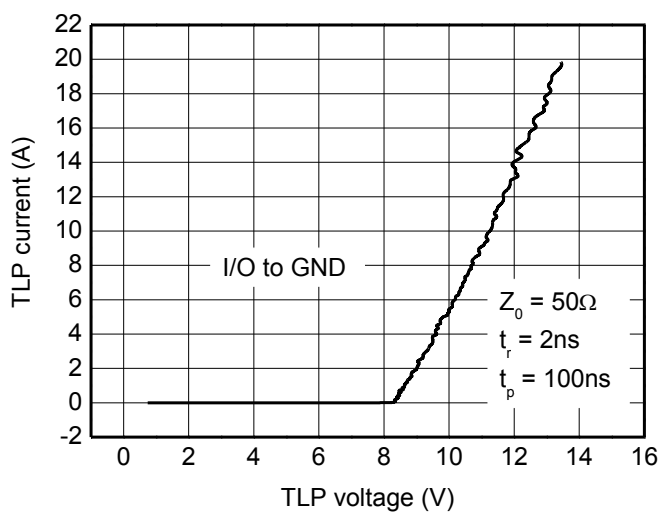

**TLP Measurement - I/O to GND**

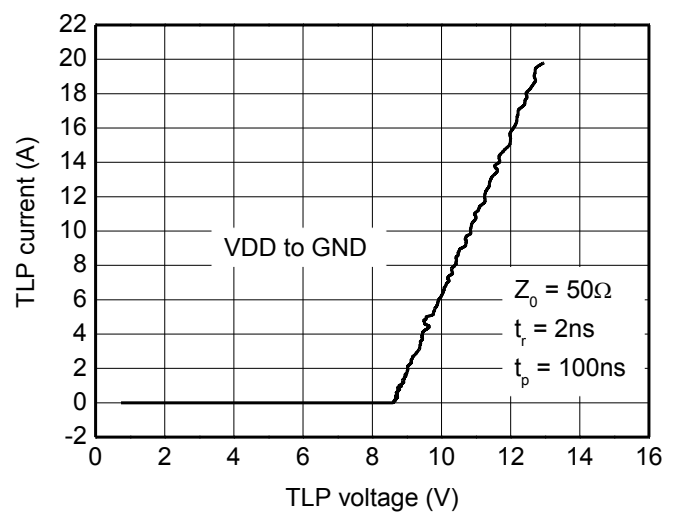

**TLP Measurement - VDD to GND**

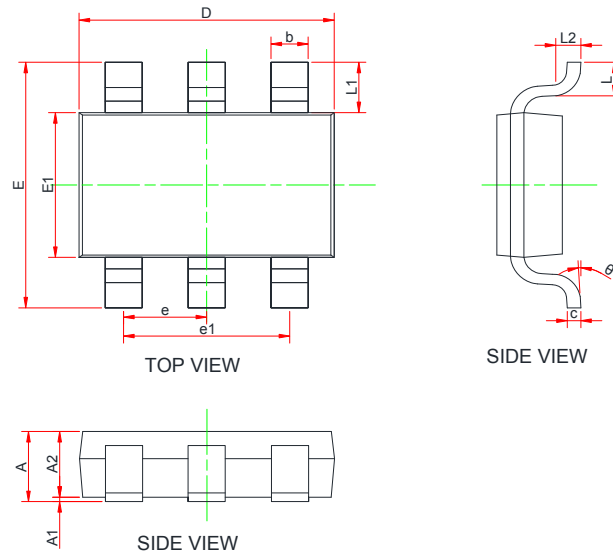
**PACKAGE OUTLINE DIMENSIONS**
**SOT-23-6L**

Symbol	Dimensions in Millimeters		
	Min.	Typ.	Max.
A	1.05	-	1.45
A1	0	-	0.15
A2	0.90	1.10	1.30
b	0.30	0.40	0.50
c	0.10	-	0.21
D	2.72	2.92	3.12
E	2.60	2.80	3.00
E1	1.40	1.60	1.80
e	0.85	0.95	1.05
e1	1.80	1.90	2.00
L	0.30	-	0.60
L1	0.59Ref		
L2	0.25Ref		
$\theta$	0 °	-	8 °

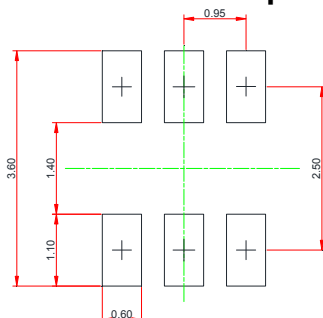
**Recommended land pattern (Unit: mm)**

**Notes:**

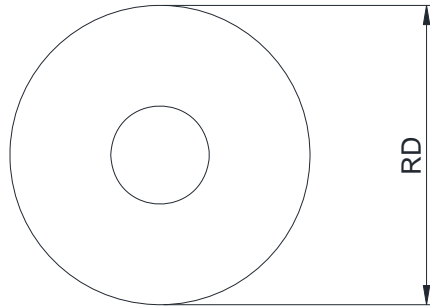
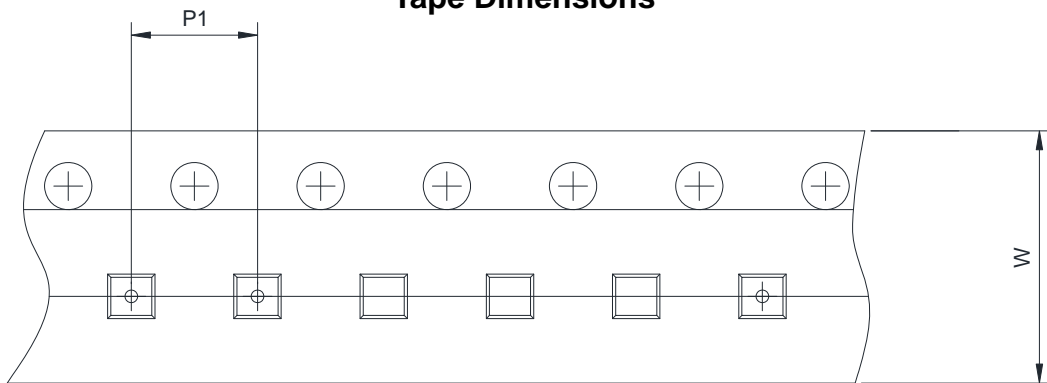
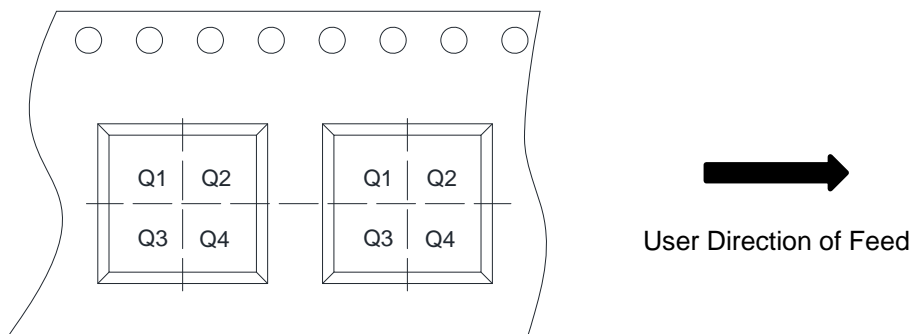
This recommended land pattern is for reference purposes only. Please consult your manufacturing group to ensure your PCB design guidelines are met.

**TAPE AND REEL INFORMATION**
**Reel Dimensions**

**Tape Dimensions**

**Quadrant Assignments For PIN1 Orientation In Tape**

RD	Reel Dimension	<input checked="" type="checkbox"/> 7inch	<input type="checkbox"/> 13inch	
W	Overall width of the carrier tape	<input checked="" type="checkbox"/> 8mm	<input type="checkbox"/> 12mm	<input type="checkbox"/> 16mm
P1	Pitch between successive cavity centers	<input type="checkbox"/> 2mm	<input checked="" type="checkbox"/> 4mm	<input type="checkbox"/> 8mm
Pin1	Pin1 Quadrant	<input type="checkbox"/> Q1	<input type="checkbox"/> Q2	<input checked="" type="checkbox"/> Q3 <input type="checkbox"/> Q4