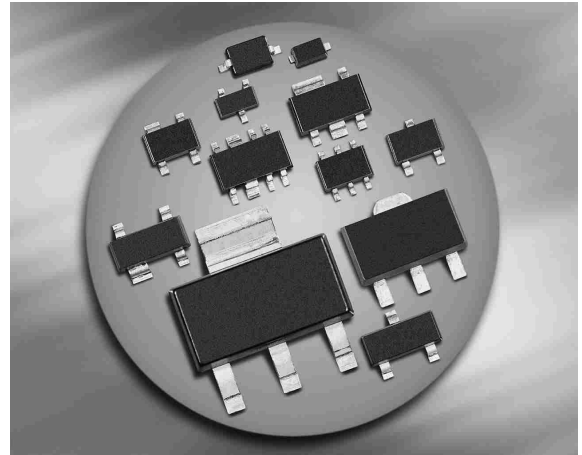
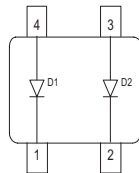
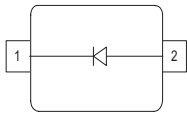

Silicon Schottky Diode

- Low barrier diode for detectors up to GHz frequencies
- For high-speed applications
- Zero bias detector diode
- Pb-free (RoHS compliant) package

BAT63-02V
BAT63-07W

ESD (Electrostatic discharge) sensitive device, observe handling precaution!

Type	Package	Configuration	L_S (nH)	Marking
BAT63-02V	SC79	single	0.6	d
BAT63-07W	SOT343	parallel pair	1.6	63s

Maximum Ratings at $T_A = 25^\circ\text{C}$, unless otherwise specified

Parameter	Symbol	Value	Unit
Diode reverse voltage	V_R	3	V
Forward current	I_F	100	mA
Total power dissipation	P_{tot}		mW
$T_S \leq 120^\circ\text{C}$, BAT63-02V		100	
$T_S \leq 114^\circ\text{C}$, BAT63-07W		100	
Junction temperature	T_j	150	$^\circ\text{C}$
Storage temperature	T_{stg}	-55 ... 150	

Thermal Resistance

Parameter	Symbol	Value	Unit
Junction - soldering point ¹⁾	R_{thJS}		K/W
BAT63-02V		≤ 295	
BAT63-07W		≤ 355	

Electrical Characteristics at $T_A = 25^\circ\text{C}$, unless otherwise specified

Parameter	Symbol	Values			Unit
		min.	typ.	max.	
DC Characteristics					
Reverse current $V_R = 3\text{ V}$	I_R	-	-	10	μA
Forward voltage $I_F = 1\text{ mA}$	V_F	-	190	300	mV
Forward voltage matching ²⁾ $I_F = 1\text{ mA}$	ΔV_F	-	-	20	
AC Characteristics					
Diode capacitance $V_R = 0.2\text{ V}, f = 1\text{ MHz}$	C_T	-	0.65	0.85	pF
Differential resistance $V_R = 0, f = 10\text{ kHz}$	R_0	-	30	-	k Ω

¹For calculation of R_{thJA} please refer to Application Note Thermal Resistance

² ΔV_F is the difference between lowest and highest V_F in a multiple diode component.

Diode capacitance $C_T = f(V_R)$

$f = 1\text{MHz}$

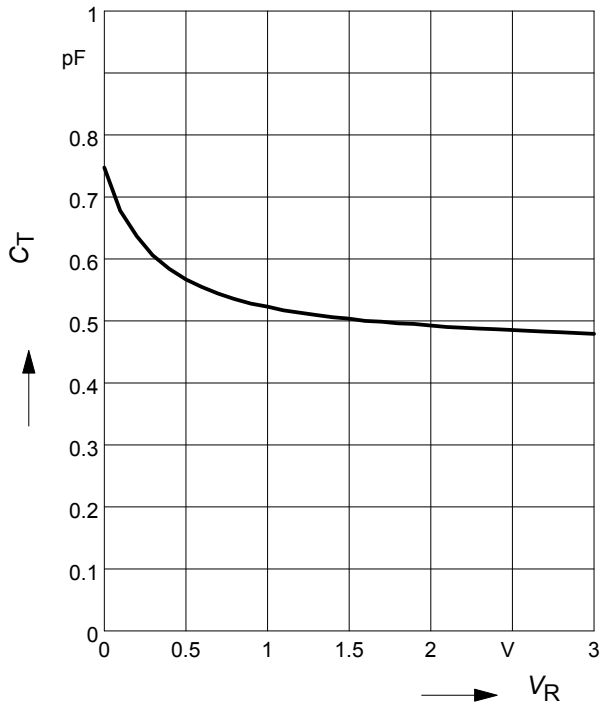

Forward current $I_F = f(V_F)$

$T_A = \text{Parameter}$

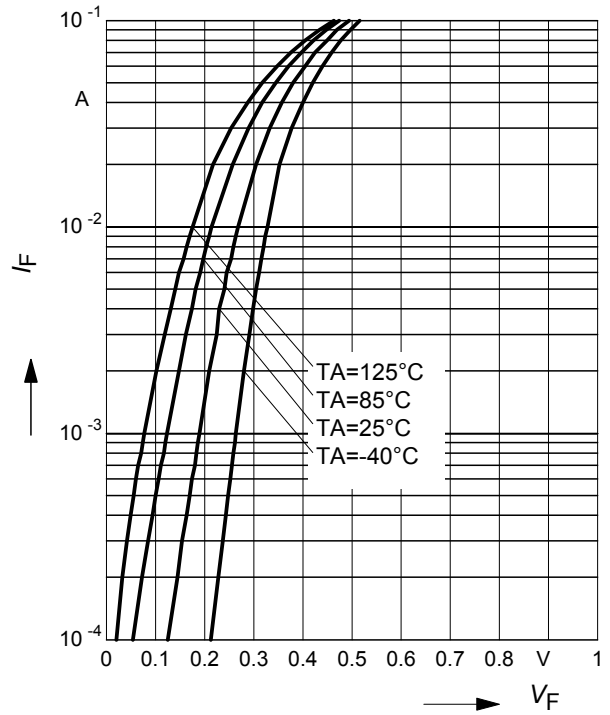

Forward current $I_F = f(T_S)$

BAT63-07W

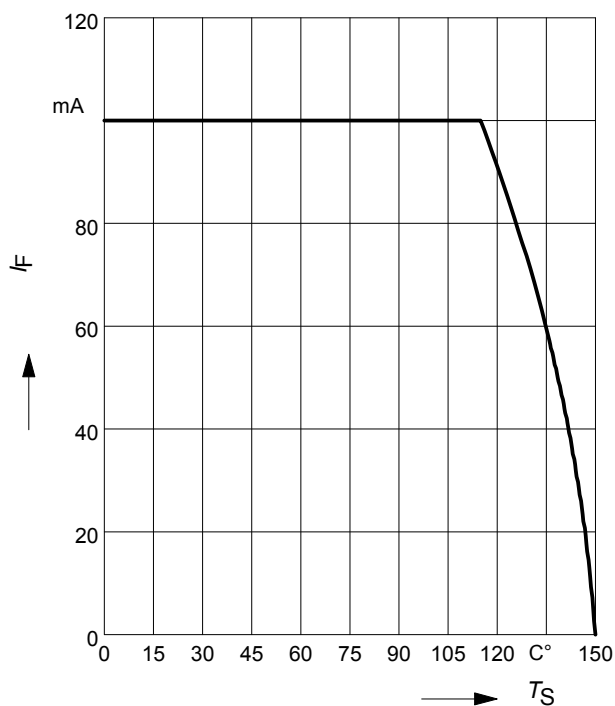

Forward current $I_F = f(T_S)$

BAT63-02V

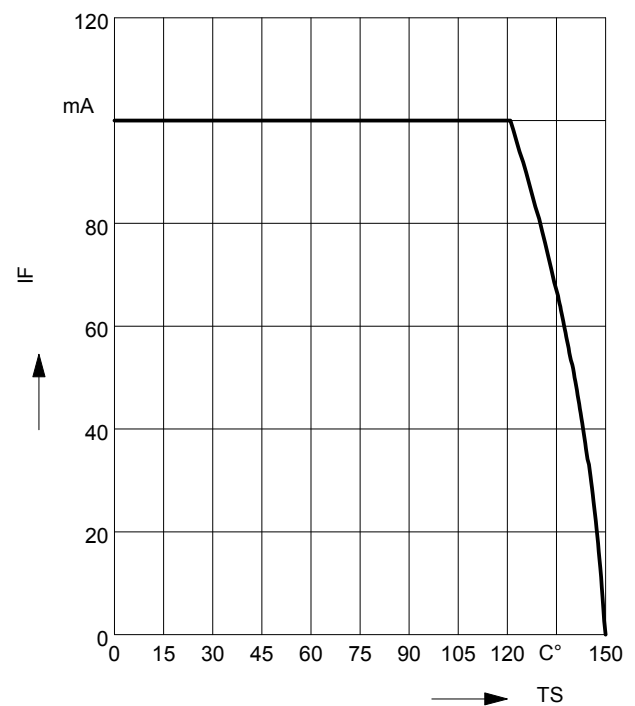

Permissible Puls Load $R_{thJS} = f(t_p)$

BAT63-07W

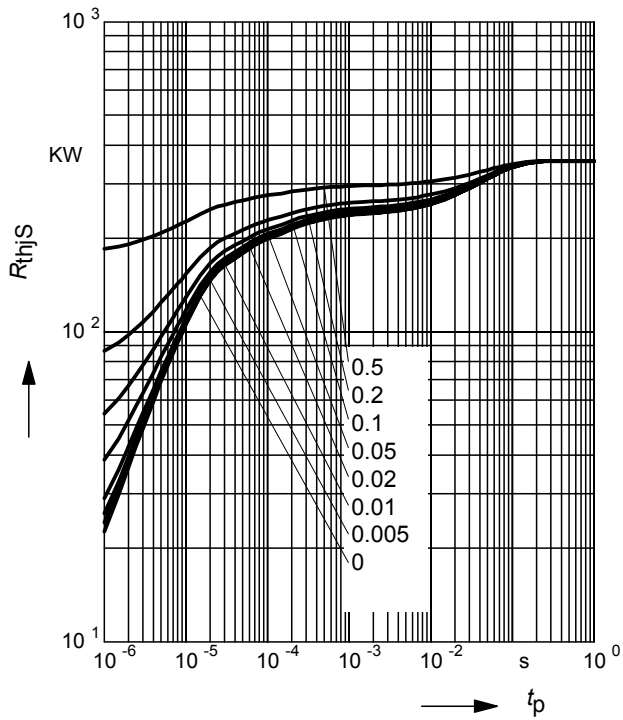

Permissible Pulse Load

$I_{Fmax} / I_{FDC} = f(t_p)$

BAT63-07W

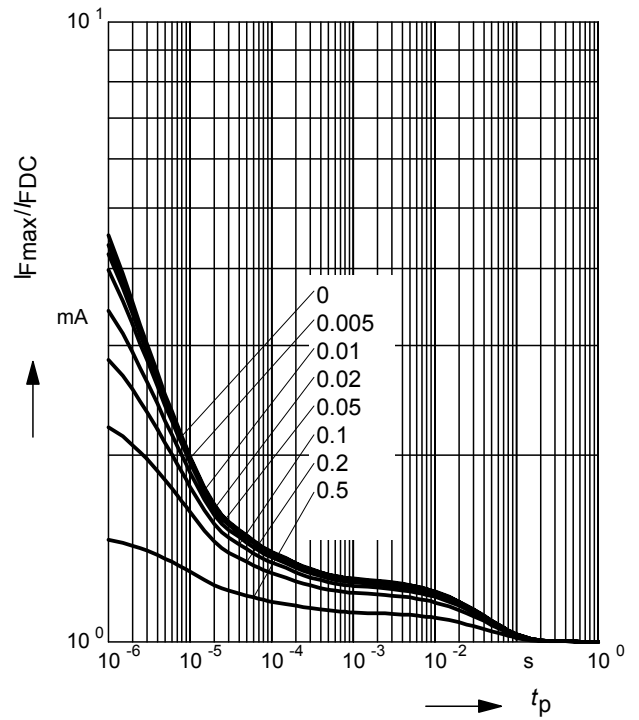

Permissible Pulse Load $R_{thJS} = f(t_p)$

BAT63-02V

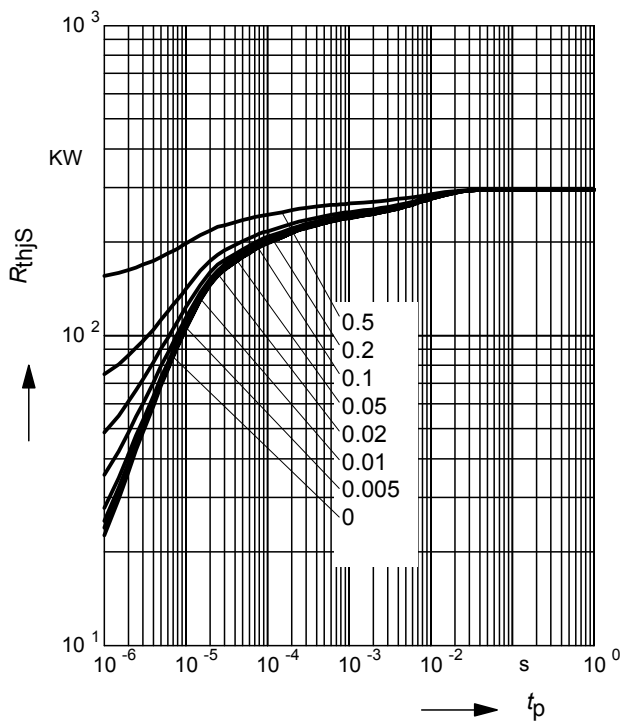

Permissible Pulse Load

$I_{Fmax} / I_{FDC} = f(t_p)$

BAT63-02V

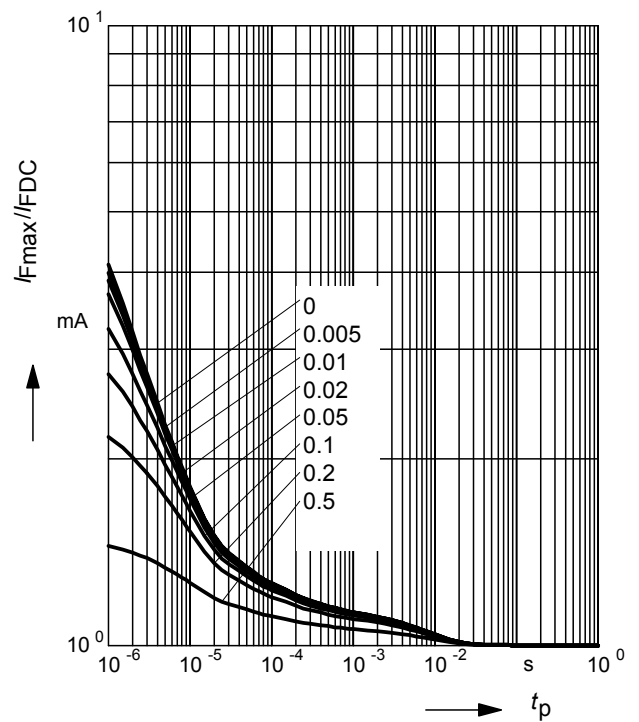

Rectifier voltage $V_{out} = f(V_{in})$

$f = 2.4\text{GHz}$

$R_L =$ Parameter in $k\Omega$

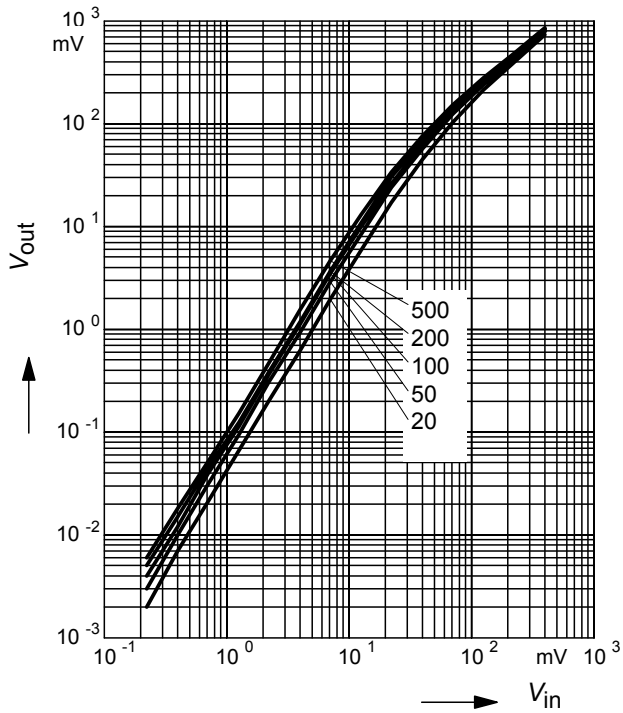

Testcircuit

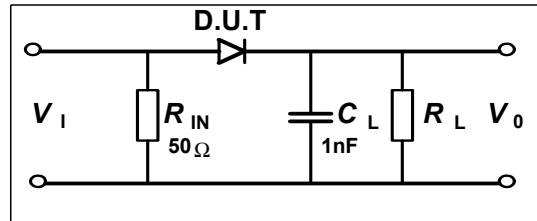

Package Outline

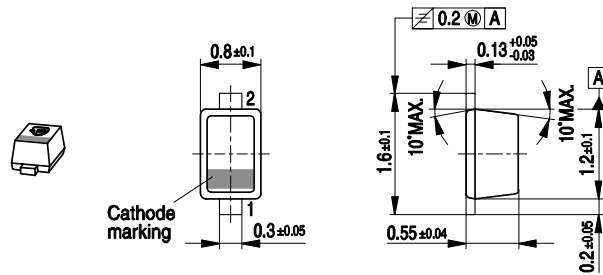

Foot Print

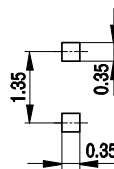

Marking Layout (Example)

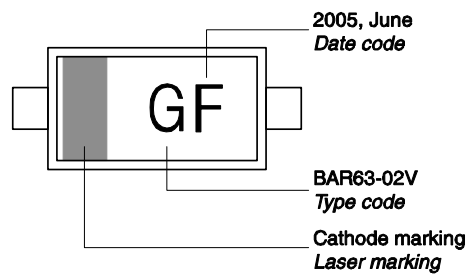

Standard Packing

- Reel \varnothing 180 mm = 3.000 Pieces/Reel
- Reel \varnothing 180 mm = 8.000 Pieces/Reel (2 mm Pitch)
- Reel \varnothing 330 mm = 10.000 Pieces/Reel

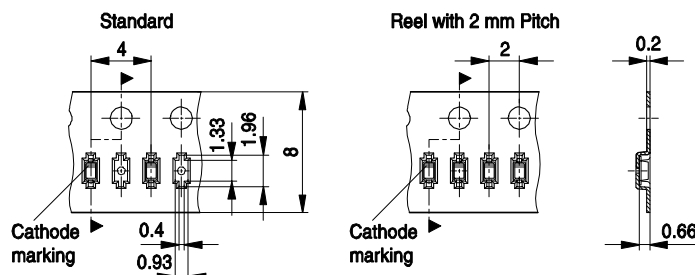

Date Code marking for discrete packages with one digit (SCD80, SC79, SC75¹⁾) CES-Code

Month	2003	2004	2005	2006	2007	2008	2009	2010	2011	2012	2013	2014
01	a	p	A	P	a	p	A	P	a	p	A	P
02	b	q	B	Q	b	q	B	Q	b	q	B	Q
03	c	r	C	R	c	r	C	R	c	r	C	R
04	d	s	D	S	d	s	D	S	d	s	D	S
05	e	t	E	T	e	t	E	T	e	t	E	T
06	f	u	F	U	f	u	F	U	f	u	F	U
07	g	v	G	V	g	v	G	V	g	v	G	V
08	h	x	H	X	h	x	H	X	h	x	H	X
09	j	y	J	Y	j	y	J	Y	j	y	J	Y
10	k	z	K	Z	k	z	K	Z	k	z	K	Z
11	l	2	L	4	l	2	L	4	l	2	L	4
12	n	3	N	5	n	3	N	5	n	3	N	5

1) New Marking Layout for SC75, implemented at October 2005.

Package Outline

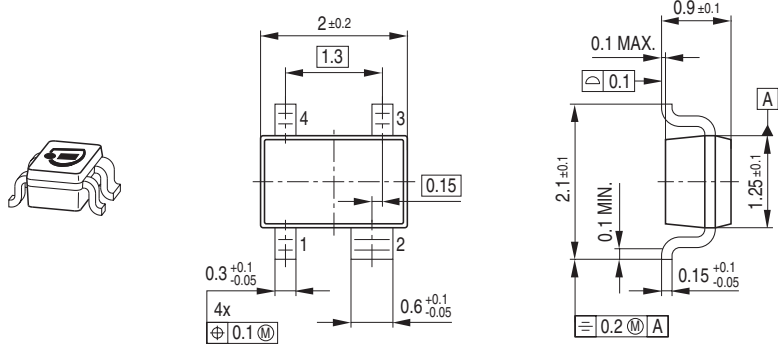

Foot Print

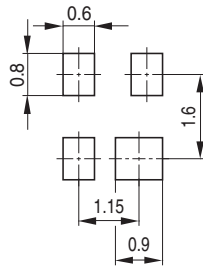

Marking Layout (Example)

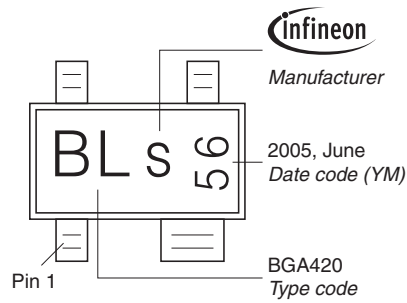

Standard Packing

Reel ø180 mm = 3.000 Pieces/Reel
 Reel ø330 mm = 10.000 Pieces/Reel

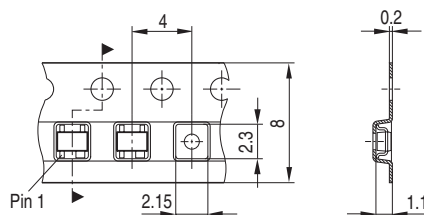

Edition 2009-11-16

**Published by
Infineon Technologies AG
81726 Munich, Germany**

**© 2009 Infineon Technologies AG
All Rights Reserved.**

Legal Disclaimer

The information given in this document shall in no event be regarded as a guarantee of conditions or characteristics. With respect to any examples or hints given herein, any typical values stated herein and/or any information regarding the application of the device, Infineon Technologies hereby disclaims any and all warranties and liabilities of any kind, including without limitation, warranties of non-infringement of intellectual property rights of any third party.

Information

For further information on technology, delivery terms and conditions and prices, please contact the nearest Infineon Technologies Office (www.infineon.com).

Warnings

Due to technical requirements, components may contain dangerous substances. For information on the types in question, please contact the nearest Infineon Technologies Office.

Infineon Technologies components may be used in life-support devices or systems only with the express written approval of Infineon Technologies, if a failure of such components can reasonably be expected to cause the failure of that life-support device or system or to affect the safety or effectiveness of that device or system. Life support devices or systems are intended to be implanted in the human body or to support and/or maintain and sustain and/or protect human life. If they fail, it is reasonable to assume that the health of the user or other persons may be endangered.