

## Features

- ◆ Ultra low capacitance: 1.5pF(Max)
- ◆ Ultra low leakage: nA level
- ◆ Low operating voltage: 5.5V
- ◆ Low clamping voltage
- ◆ Complies with following standards:
  - IEC 61000-4-2 (ESD) immunity test
    - Air discharge: ±20kV
    - Contact discharge: ±15kV
  - IEC61000-4-4 (EFT) 40A (5/50ns)
- ◆ ROHS Compliant

## Ordering Information

Part Number	Qty per Reel	Reel Size
TPD4E004DRYR-TP	5000	7"

## Mechanical Characteristics

- ◆ Package: SON-6(1.45X1.0)
- ◆ Lead Finish: Matte Tin
- ◆ Case Material: "Green" Molding Compound.
- ◆ UL Flammability Classification Rating 94V-0
- ◆ Moisture Sensitivity: Level 3 per J-STD-020

## Applications

- ◆ USB 2.0 and USB 3.0 Ports
- ◆ USB OTG
- ◆ Digital video interface(DVI)
- ◆ Monitor and Flat Panel Displays
- ◆ PCI Express and Serial SATA Ports
- ◆ Gigabit Ethernet
- ◆ IEEE 1394 firewire ports
- ◆ Consumer products (STB, DVD, DSC, DVC...)

## Dimensions and Pin Configuration

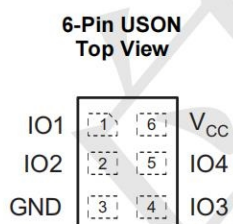

Marking: 2P

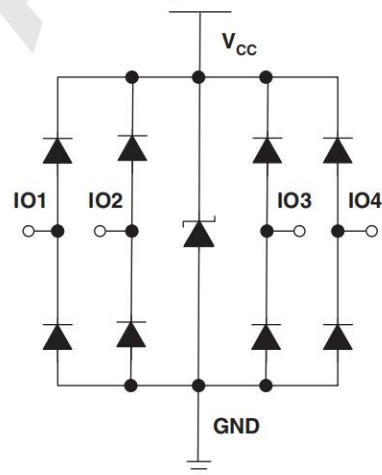

**Absolute Maximum Ratings** (T<sub>amb</sub>=25°C unless otherwise specified)

Parameter	Symbol	Value	Unit
Power pin voltage	V <sub>CC</sub>	7	V
ESD Protection (per IEC 61000-4-2)	Air Discharge WM	20	kV
	Contact Discharge BR	15	

Parameter	Symbol	Min.	Nom.	Max.	Unit
Operating Temperature	T <sub>J</sub>	-55	+25	+150	°C
Storage Temperature	T <sub>STG</sub>	-55	+25	+150	°C

**Electrical Characteristics** (T<sub>A</sub>=25°C unless otherwise specified)

Parameter	Symbol	Min	Typ	Max	Unit
Working Peak Reverse Voltage	V <sub>WM</sub>			5.5	V
Breakdown Voltage @ 1 mA	V <sub>BR</sub>	6.5	8	11	V
Leakage Current @ V <sub>WM</sub>	I <sub>D</sub>			0.1	μA
Capacitance	C <sub>J(SD)</sub>			1.5	pF
Forward Surge Rating (1/20 s @ 25 °C, I <sub>F</sub> = 10 mA)	V <sub>F</sub>	0.6		1.2	V
Clamping Voltage (per IEC 61000-4-5) 8/20 μs)	@ I <sub>PP</sub> = 1 A			12	V
	@ I <sub>PP</sub> = 5 A			15	

**Typical Performance Characteristics ( $T_A=25^\circ\text{C}$  unless otherwise Specified)**

**Fig1. 8/20 $\mu\text{s}$  Pulse Waveform**

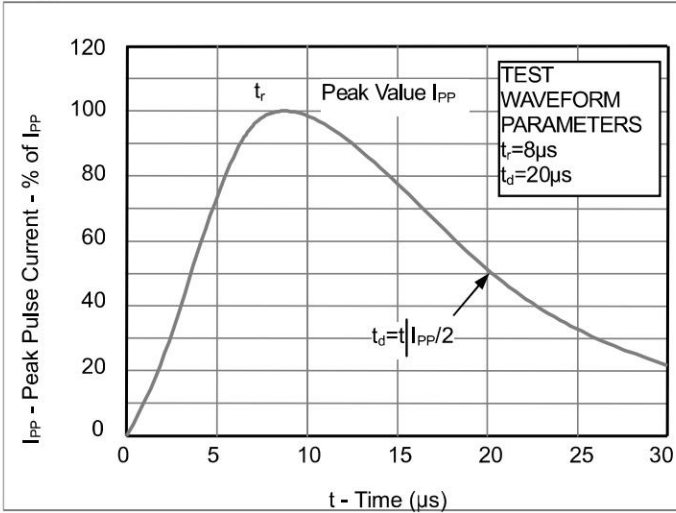

**Fig2. ESD Pulse Waveform (according to IEC 61000-4-2)**

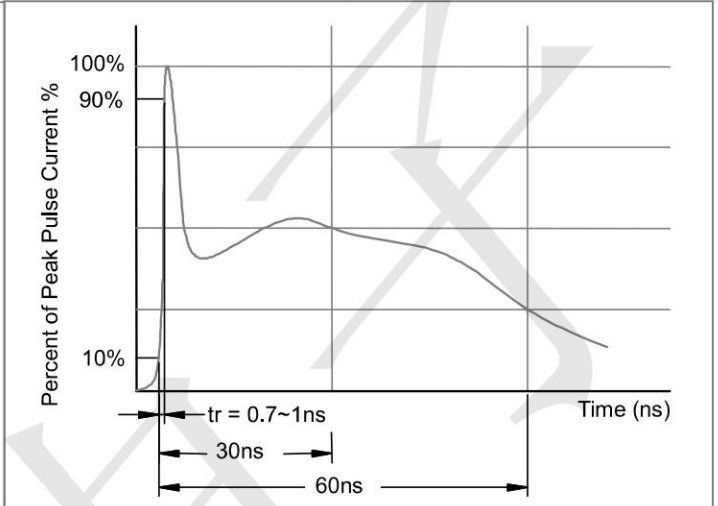

**Fig3. Power Derating Curve**

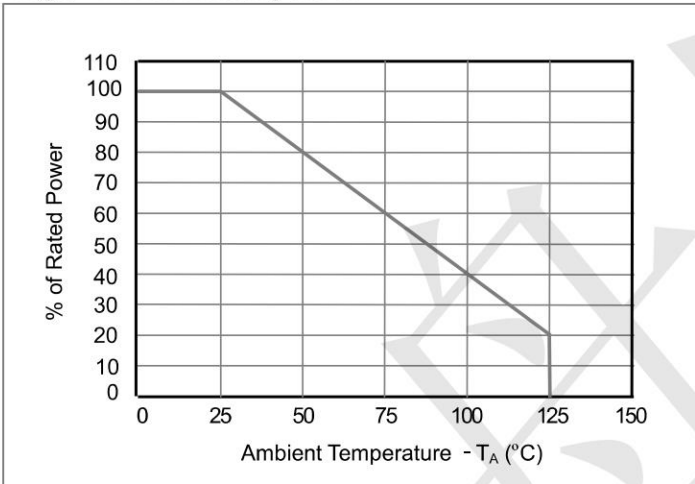

**SON-6(1.45x1) Package Outline Drawing**

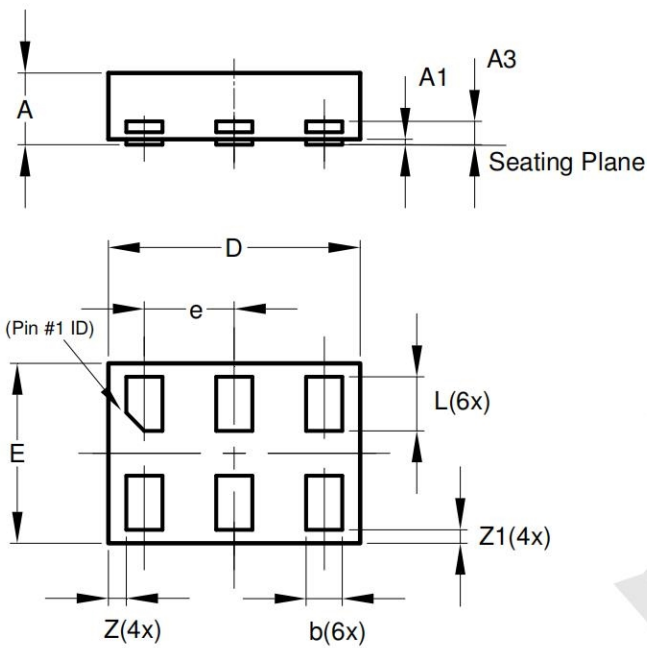

X2-DFN1410-6			
Dim	Min	Max	Typ
A	—	0.40	0.39
A1	0.00	0.05	0.02
A3	—	—	0.13
b	0.15	0.25	0.20
D	1.35	1.45	1.40
E	0.95	1.05	1.00
e	—	—	0.50
L	0.25	0.35	0.30
Z	—	—	0.10
Z1	0.045	0.105	0.075
All Dimensions in mm			

**Suggested Land Pattern**

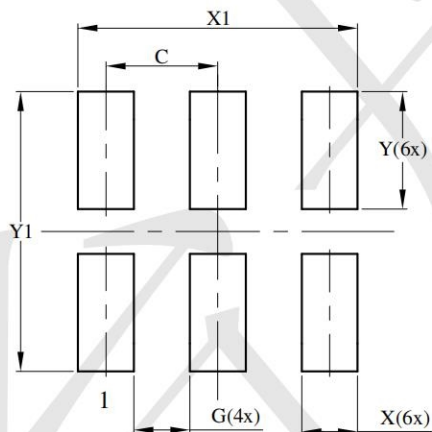

Dimensions	Value (in mm)
C	0.500
G	0.250
X	0.250
X1	1.250
Y	0.525
Y1	1.250