

SA Series

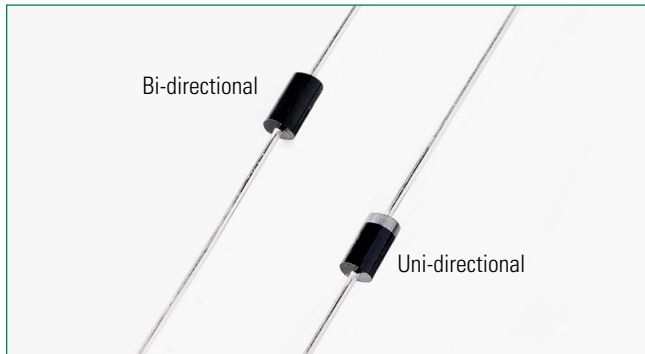

Agency Approvals

| Agency | Agency File Number |
|--------|--------------------|
| | E230531 |

Maximum Ratings and Thermal Characteristics (T_A = 25°C unless otherwise noted)

| Parameter | Symbol | Value | Unit |
|--|-----------------------------------|------------|------|
| Peak Pulse Power Dissipation by 10/1000µs Test Waveform (Fig.2)(Note 1) | P _{PPM} | 500 | W |
| Steady State Power Dissipation on Infinite Heat Sink at T _L = 75°C | P _D | 3.0 | W |
| Peak Forward Surge Current, 8.3ms Single Half Sine Wave Unidirectional Only (Note 2) | I _{FSM} | 70 | A |
| Maximum Instantaneous Forward Voltage at 35A for Unidirectional Only | V _F | 3.5 | V |
| Operating Junction and Storage Temperature Range | T _J , T _{STG} | -65 to 175 | °C |
| Typical Thermal Resistance Junction to Lead | R _{θJL} | 20 | °C/W |
| Typical Thermal Resistance Junction to Ambient | R _{θJA} | 75 | °C/W |

Notes:
 1. Non-repetitive current pulse, per Fig. 4 and derated above T_J (initial) = 25°C per Fig. 3.
 2. Measured on 8.3ms single half sine wave or equivalent square wave, duty cycle=4 per minute maximum.

Functional Diagram

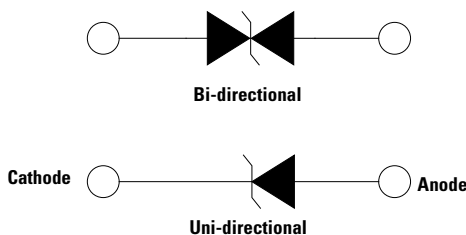

Description

The SA Series is designed specifically to protect sensitive electronic equipment from voltage transients induced by lightning and other transient voltage events.

Features

- 500W peak pulse capability at 10/1000µs waveform, repetition rate (duty cycles):0.01 %
- V_{BR} @ T_J = V_{BR} @ 25°C x (1 + α T (T_J - 25)) (α T: Temperature Coefficient, typical value is 0.1 %)
- Glass passivated chip junction in DO-15 Package
- Fast response time: typically less than 1.0ps from 0 Volts to BV min
- Excellent clamping capability
- Typical failure mode is short from over-specified voltage or current
- Whisker test is conducted based on JEDEC JESD201A per its table 4a and 4c
- IEC-61000-4-2 ESD 30kV(Air), 30kV (Contact)
- ESD protection of data lines in accordance with IEC 61000-4-2
- EFT protection of data lines in accordance with IEC 61000-4-4
- Low incremental surge resistance
- Typical I_R less than 1µA when V_{BR} max > 13V
- High temperature to reflow soldering guaranteed: 260°C/40sec / 0.375"/(9.5mm) lead length, 5 lbs., (2.3kg) tension
- Plastic package is flammability rated V-0 per Underwriters Laboratories
- Matte tin lead-free plated
- Halogen free and RoHS compliant
- Pb-free E3 means 2nd level interconnect is Pb-free and the terminal finish material is tin(Sn) (IPC/ JEDEC J-STD-609A.01)

Applications

TVS devices are ideal for the protection of I/O interfaces, V_{CC} bus and other vulnerable circuits used in telecom, computer, industrial and consumer electronic applications.

Additional Information



Electrical Characteristics (T_A=25°C unless otherwise noted)

| Part Number (Uni) | Part Number (Bi) | Reverse Stand off Voltage V _R (V) | Breakdown Voltage V _{BR} (Volts) @ I _T | | Test Current I _T (mA) | Maximum Clamping Voltage V _C @ I _{PP} (V) | Maximum Peak Pulse Current I _{PP} (A) | Maximum Reverse Leakage I _R @ V _R (μA) | Agency Approval  |
|-------------------|------------------|--|--|--------|----------------------------------|---|--|--|---|
| | | | Min. | Max. | | | | | |
| SA5.0A | SA5.0CA | 5.0 | 6.40 | 7.00 | 10 | 9.2 | 55.4 | 600 | X |
| SA6.0A | SA6.0CA | 6.0 | 6.67 | 7.37 | 10 | 10.3 | 49.5 | 600 | X |
| SA6.5A | SA6.5CA | 6.5 | 7.22 | 7.98 | 10 | 11.2 | 45.5 | 400 | X |
| SA7.0A | SA7.0CA | 7.0 | 7.78 | 8.60 | 10 | 12.0 | 42.5 | 150 | X |
| SA7.5A | SA7.5CA | 7.5 | 8.33 | 9.21 | 1 | 12.9 | 39.5 | 50 | X |
| SA8.0A | SA8.0CA | 8.0 | 8.89 | 9.83 | 1 | 13.6 | 37.5 | 25 | X |
| SA8.5A | SA8.5CA | 8.5 | 9.44 | 10.40 | 1 | 14.4 | 35.4 | 10 | X |
| SA9.0A | SA9.0CA | 9.0 | 10.00 | 11.10 | 1 | 15.4 | 33.1 | 5 | X |
| SA10A | SA10CA | 10.0 | 11.10 | 12.30 | 1 | 17.0 | 30.0 | 3 | X |
| SA11A | SA11CA | 11.0 | 12.20 | 13.50 | 1 | 18.2 | 28.0 | 1 | X |
| SA12A | SA12CA | 12.0 | 13.30 | 14.70 | 1 | 19.9 | 25.6 | 1 | X |
| SA13A | SA13CA | 13.0 | 14.40 | 15.90 | 1 | 21.5 | 23.7 | 1 | X |
| SA14A | SA14CA | 14.0 | 15.60 | 17.20 | 1 | 23.2 | 22.0 | 1 | X |
| SA15A | SA15CA | 15.0 | 16.70 | 18.50 | 1 | 24.4 | 20.9 | 1 | X |
| SA16A | SA16CA | 16.0 | 17.80 | 19.70 | 1 | 26.0 | 19.6 | 1 | X |
| SA17A | SA17CA | 17.0 | 18.90 | 20.90 | 1 | 27.6 | 18.5 | 1 | X |
| SA18A | SA18CA | 18.0 | 20.00 | 22.10 | 1 | 29.2 | 17.5 | 1 | X |
| SA20A | SA20CA | 20.0 | 22.20 | 24.50 | 1 | 32.4 | 15.7 | 1 | X |
| SA22A | SA22CA | 22.0 | 24.40 | 26.90 | 1 | 35.5 | 14.4 | 1 | X |
| SA24A | SA24CA | 24.0 | 26.70 | 29.50 | 1 | 38.9 | 13.1 | 1 | X |
| SA26A | SA26CA | 26.0 | 28.90 | 31.90 | 1 | 42.1 | 12.1 | 1 | X |
| SA28A | SA28CA | 28.0 | 31.10 | 34.40 | 1 | 45.4 | 11.2 | 1 | X |
| SA30A | SA30CA | 30.0 | 33.30 | 36.80 | 1 | 48.4 | 10.5 | 1 | X |
| SA33A | SA33CA | 33.0 | 36.70 | 40.60 | 1 | 53.3 | 9.6 | 1 | X |
| SA36A | SA36CA | 36.0 | 40.00 | 44.20 | 1 | 58.1 | 8.8 | 1 | X |
| SA40A | SA40CA | 40.0 | 44.40 | 49.10 | 1 | 64.5 | 7.9 | 1 | X |
| SA43A | SA43CA | 43.0 | 47.80 | 52.80 | 1 | 69.4 | 7.3 | 1 | X |
| SA45A | SA45CA | 45.0 | 50.00 | 55.30 | 1 | 72.7 | 7.0 | 1 | X |
| SA48A | SA48CA | 48.0 | 53.30 | 58.90 | 1 | 77.4 | 6.6 | 1 | X |
| SA51A | SA51CA | 51.0 | 56.70 | 62.70 | 1 | 82.4 | 6.2 | 1 | X |
| SA54A | SA54CA | 54.0 | 60.00 | 66.30 | 1 | 87.1 | 5.9 | 1 | X |
| SA58A | SA58CA | 58.0 | 64.40 | 71.20 | 1 | 93.6 | 5.4 | 1 | X |
| SA60A | SA60CA | 60.0 | 66.70 | 73.70 | 1 | 96.8 | 5.3 | 1 | X |
| SA64A | SA64CA | 64.0 | 71.10 | 78.60 | 1 | 103.0 | 5.0 | 1 | X |
| SA70A | SA70CA | 70.0 | 77.80 | 86.00 | 1 | 113.0 | 4.5 | 1 | X |
| SA75A | SA75CA | 75.0 | 83.30 | 92.10 | 1 | 121.0 | 4.2 | 1 | X |
| SA78A | SA78CA | 78.0 | 86.70 | 95.80 | 1 | 126.0 | 4.0 | 1 | X |
| SA85A | SA85CA | 85.0 | 94.40 | 104.00 | 1 | 137.0 | 3.7 | 1 | X |
| SA90A | SA90CA | 90.0 | 100.00 | 111.00 | 1 | 146.0 | 3.5 | 1 | X |
| SA100A | SA100CA | 100.0 | 111.00 | 123.00 | 1 | 162.0 | 3.1 | 1 | X |
| SA110A | SA110CA | 110.0 | 122.00 | 135.00 | 1 | 177.0 | 2.9 | 1 | X |
| SA120A | SA120CA | 120.0 | 133.00 | 147.00 | 1 | 193.0 | 2.6 | 1 | X |
| SA130A | SA130CA | 130.0 | 144.00 | 159.00 | 1 | 209.0 | 2.4 | 1 | X |
| SA150A | SA150CA | 150.0 | 167.00 | 185.00 | 1 | 243.0 | 2.1 | 1 | X |
| SA160A | SA160CA | 160.0 | 178.00 | 197.00 | 1 | 259.0 | 2.0 | 1 | X |
| SA170A | SA170CA | 170.0 | 189.00 | 209.00 | 1 | 275.0 | 1.9 | 1 | X |
| SA180A | SA180CA | 180.0 | 200.00 | 221.00 | 1 | 289.0 | 1.7 | 1 | X |

For bidirectional type having V_R of 10 volts and less, the I_R limit is double.

For parts without A, the V_{BR} is ± 10% and V_C is 5% higher than with A parts, the parts without A are currently available, but not recommended for new designs. The parts with A are preferred.

I-V Curve Characteristics

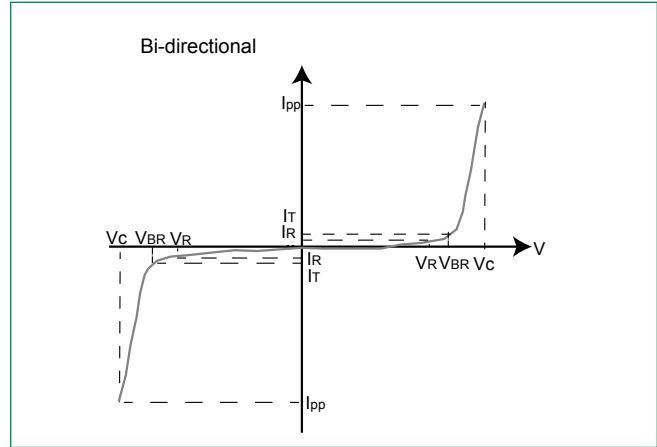
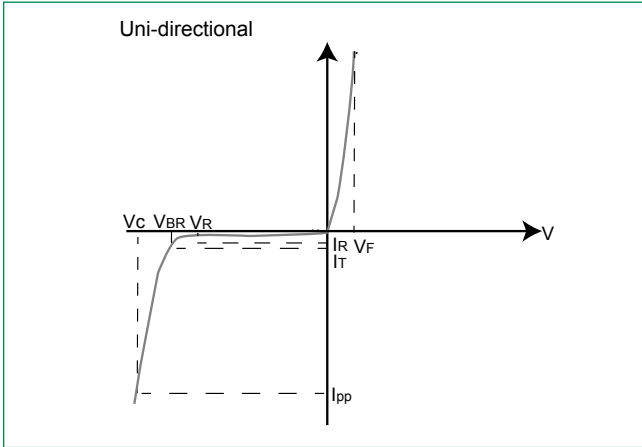

- P_{PPM} Peak Pulse Power Dissipation** – Max power dissipation
- V_R Stand-off Voltage** – Maximum voltage that can be applied to the TVS without operation
- V_{BR} Breakdown Voltage** – Maximum voltage that flows through the TVS at a specified test current (I_T)
- V_C Clamping Voltage** – Peak voltage measured across the TVS at a specified I_{ppm} (peak impulse current)
- I_R Reverse Leakage Current** – Current measured at V_R
- V_F Forward Voltage Drop for Uni-directional**

Ratings and Characteristic Curves ($T_A=25^\circ C$ unless otherwise noted)

Figure 1 - TVS Transients Clamping Waveform

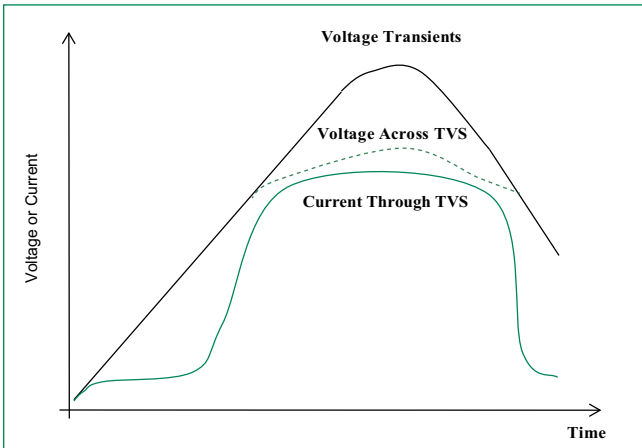
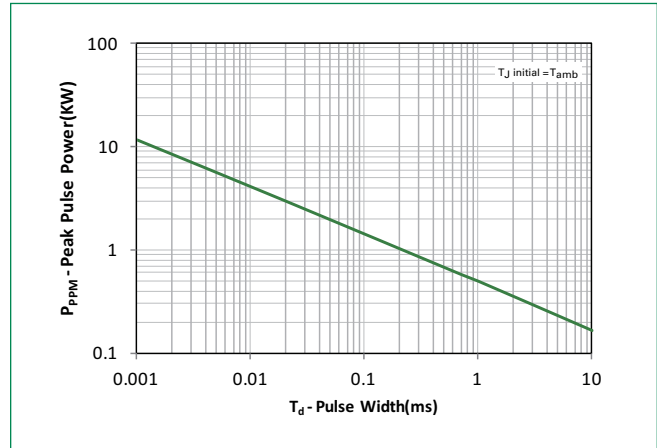

Figure 2 - Peak Pulse Power Rating



Ratings and Characteristic Curves ($T_A=25^\circ\text{C}$ unless otherwise noted) (Continued)

Figure 3 - Peak Pulse Power Derating Curve

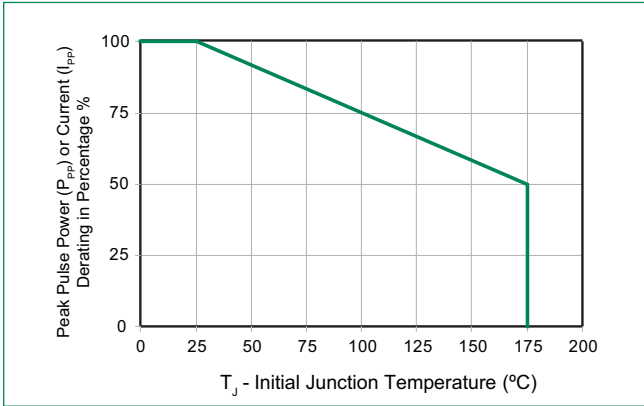

Figure 4 - Pulse Waveform

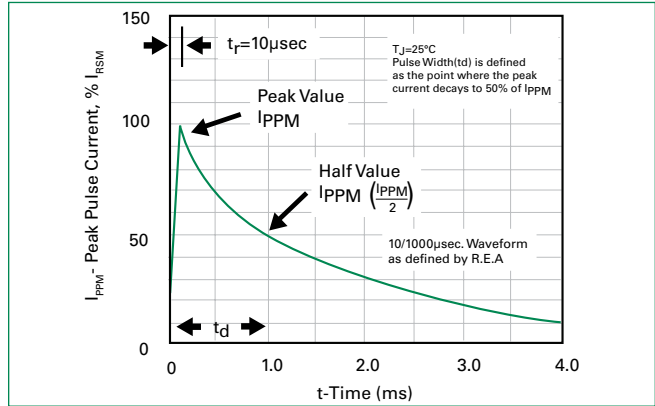

Figure 5 - Typical Junction Capacitance

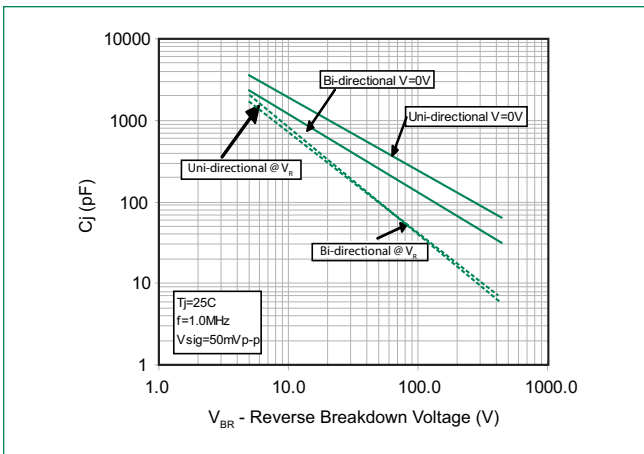

Figure 6 - Typical Transient Thermal Impedance

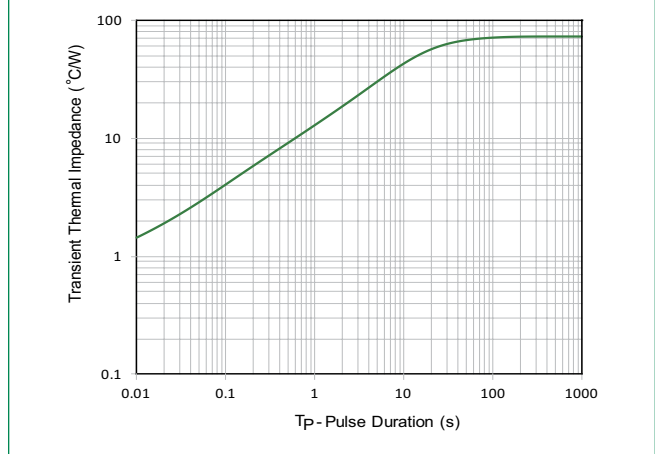

Figure 7 - Maximum Non-Repetitive Forward Surge Current Uni-Directional Only

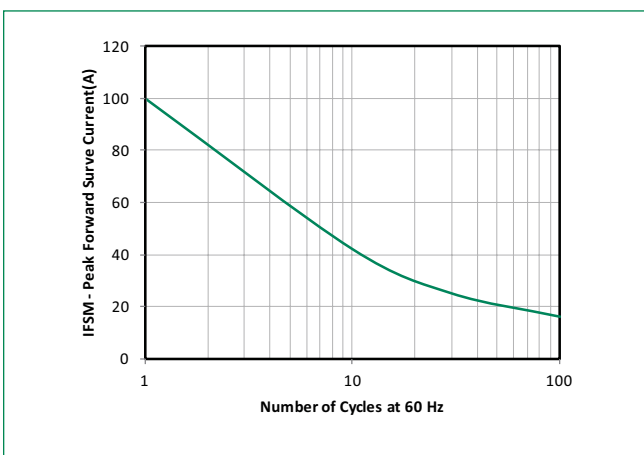
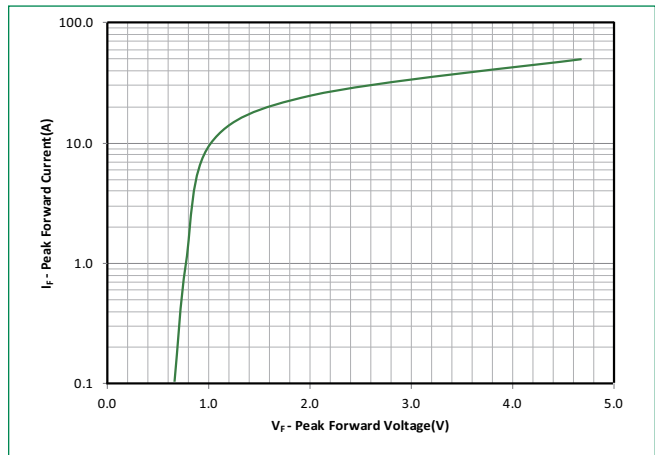
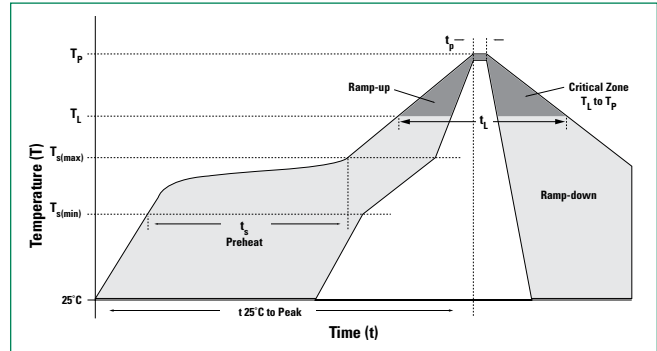

Figure 8 - Peak Forward Voltage Drop vs Peak Forward Current (Typical Values)



Soldering Parameters

| | | |
|---|------------------------------------|-------------------------|
| Reflow Condition | | Lead-free assembly |
| Pre Heat | - Temperature Min ($T_{s(min)}$) | 150°C |
| | - Temperature Max ($T_{s(max)}$) | 200°C |
| | - Time (min to max) (t_s) | 60 – 180 secs |
| Average ramp up rate (Liquidus Temp (T_A) to peak | | 3°C/second max |
| $T_{s(max)}$ to T_A - Ramp-up Rate | | 3°C/second max |
| Reflow | - Temperature (T_A) (Liquidus) | 217°C |
| | - Time (min to max) (t_s) | 60 – 150 seconds |
| Peak Temperature (T_p) | | 260 ^{+0/-5} °C |
| Time within 5°C of actual peak Temperature (t_p) | | 20 – 40 seconds |
| Ramp-down Rate | | 6°C/second max |
| Time 25°C to peak Temperature (T_p) | | 8 minutes Max. |
| Do not exceed | | 260°C |



Flow/Wave Soldering (Solder Dipping)

| | |
|---------------------------|------------|
| Peak Temperature : | 265°C |
| Dipping Time : | 10 seconds |
| Soldering : | 1 time |

Physical Specifications

| | |
|-----------------|--|
| Weight | 0.015oz., 0.4g |
| Case | JEDEC DO-204AC (DO-15) molded plastic body over passivated junction. |
| Polarity | Color band denotes the cathode except Bipolar. |
| Terminal | Matte Tin axial leads, solderable per JESD22-B102. |

Environmental Specifications

| | |
|----------------------------|-------------|
| High Temp. Storage | JESD22-A103 |
| HTRB | JESD22-A108 |
| Temperature Cycling | JESD22-A104 |
| H3TRB | JESD22-A101 |
| RSH | JESD22-B106 |

Dimensions

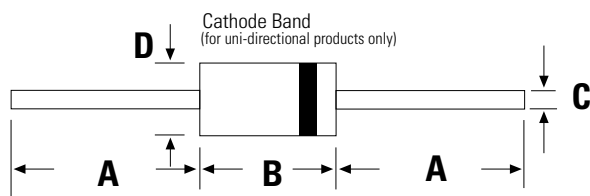

DO-204AC (DO-15)

| Dimensions | Inches | | Millimeters | |
|------------|--------|-------|-------------|------|
| | Min | Max | Min | Max |
| A | 1.000 | - | 25.40 | - |
| B | 0.230 | 0.300 | 5.80 | 7.60 |
| C | 0.028 | 0.034 | 0.71 | 0.86 |
| D | 0.104 | 0.140 | 2.60 | 3.60 |

Part Numbering System

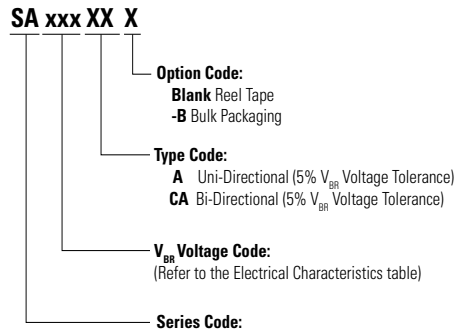

Part Marking System

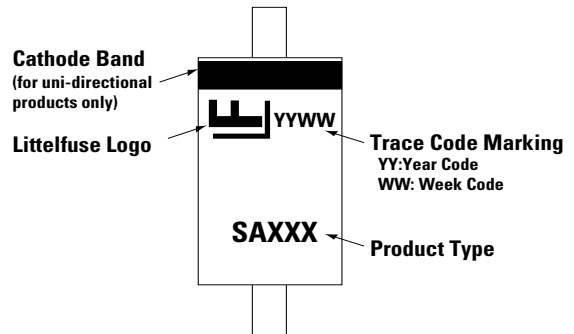

Packaging

| Part Number | Component Package | Quantity | Packaging Option | Packaging Specification |
|-------------|-------------------|----------|------------------|-------------------------|
| SAxxxXX | DO-204AC | 4000 | Tape & Reel | EIA STD RS-296 |
| SAxxxXX-B | DO-204AC | 1000 | Bulk | Littelfuse Spec. |

Tape and Reel Specification

