

LP2615DT2AG

P-Channel 60-V (D-S) MOSFET

1. FEATURES

- Low RDS(on) trench technology
- Low thermal impedance
- Fast switching speed
- We declare that the material of product compliance with RoHS requirements and Halogen Free.

2. APPLICATIONS

- Load Switches
- DC/DC Conversion
- Motor Drives

3. DEVICE MARKING AND ORDERING INFORMATION

Device	Marking	Shipping
LP2615DT2AG	5DT	4000/Tape&Reel

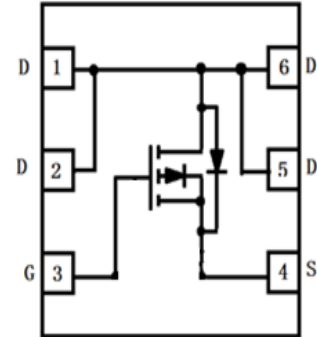
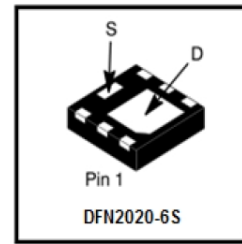

4. MAXIMUM RATINGS(Ta = 25°C)

Parameter	Symbol	Limits	Unit
Drain-Source Voltage	VDSS	-60	V
Gate-to-Source Voltage	VGS	±20	V
Continuous Drain Current(Note 1)	ID	TA = 25°C	-5
		TA = 70°C	-3
Pulsed Drain Current(Note 2)	IDM	-20	A
Continuous Source Current (Diode Conduction)(Note 1)	IS	-5	A
Power Dissipation(Note 1)	PD	TA = 25°C	1.9
		TA = 70°C	1
Operating and Storage Temperature Range	TJ,Tstg	-55~+150	°C

5. THERMAL CHARACTERISTICS

Parameter	Symbol	Max	Unit
Maximum Junction-to-Ambient (Note 1)	RθJA	t ≤ 10S	45
		Steady State	95

1.Surface mounted on "1.5 x 1.5" FR4 board using 1 sq in pad, 2 oz Cu.

2.Pulse width limited by maximum junction temperature

6. ELECTRICAL CHARACTERISTICS (Ta= 25°C)

Characteristic	Symbol	Min.	Typ.	Max.	Unit	
STATIC						
Drain–Source Breakdown Voltage (VGS = 0, ID = -250μA)	VBRDSS	-60	-	-	V	
Gate-Source Threshold Voltage (VGS = VDS , ID = -250μA)	VGS(th)	-1	-	-	V	
Gate-to–Source Leakage Current (VDS = 0 V, VGS = ±20 V)	IGSS	-	-	±10	μA	
Zero Gate Voltage Drain Current (VDS = -48 V, VGS = 0 V) (VDS = -48 V, VGS = 0 V, TJ = 55°C)	IDSS	-	-	-1 -10	μA	
Static Drain–Source On–State Resistance(Note 3) (VGS = -10 V, ID = -4 A) (VGS = -4.5 V, ID = -3.2 A)	RDS(on)	-	-	82 100	mΩ	
Forward Diode Voltage(Note 3) (IS = -2.1 A, VGS = 0 V)	VSD	-	-0.83	-	V	
DYNAMIC						
Total Gate Charge	(VDS = -30 V, VGS = -4.5 V, ID = -4 A)	Qg	-	8.8	-	nC
Gate-to–Source Charge		Qgs	-	2.2	-	
Gate-to–Drain Charge		Qgd	-	3.5	-	
Turn–On Delay Time	(VDS=-30 V, RL=7.5 Ω, ID=-4 A, VGEN =-10 V, RGEN= 6 Ω)	td(on)	-	7	-	ns
Turn–On Rise Time		tr	-	5	-	
Turn–Off Delay Time		td(off)	-	37	-	
Turn–Off Fall Time		tf	-	14	-	
Input Capacitance	(VDS = -15 V, VGS = 0 V, f = 1 MHz)	Ciss	-	1104	-	pF
Output Capacitance		Coss	-	66.7	-	
Reverse Transfer Capacitance		Crss	-	55.5	-	
Gate-Resistance (VGS = 0 V, VDS=0V,f=1MHz)	Rg	-	6.8	-	Ω	

3.Pulse Test: Pulse Width ≤300 μs, Duty Cycle ≤2.0%.

7. ELECTRICAL CHARACTERISTICS CURVES

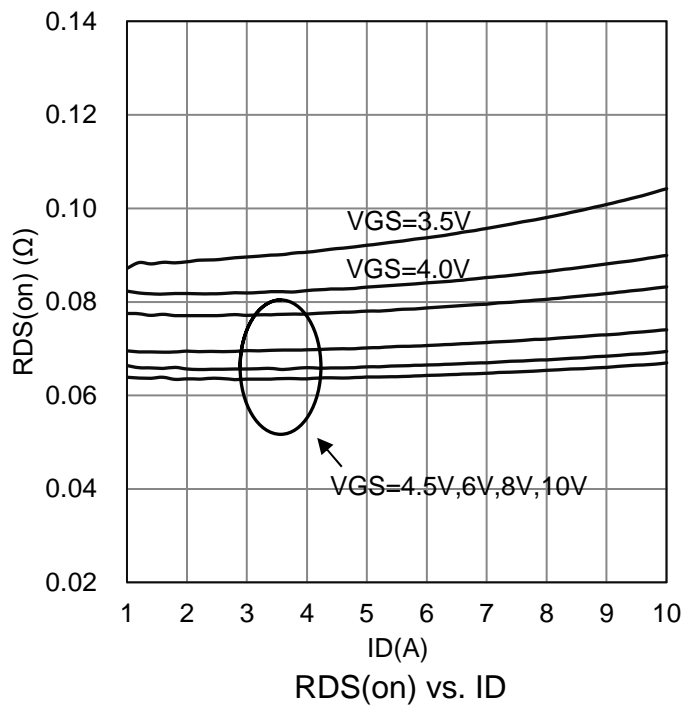
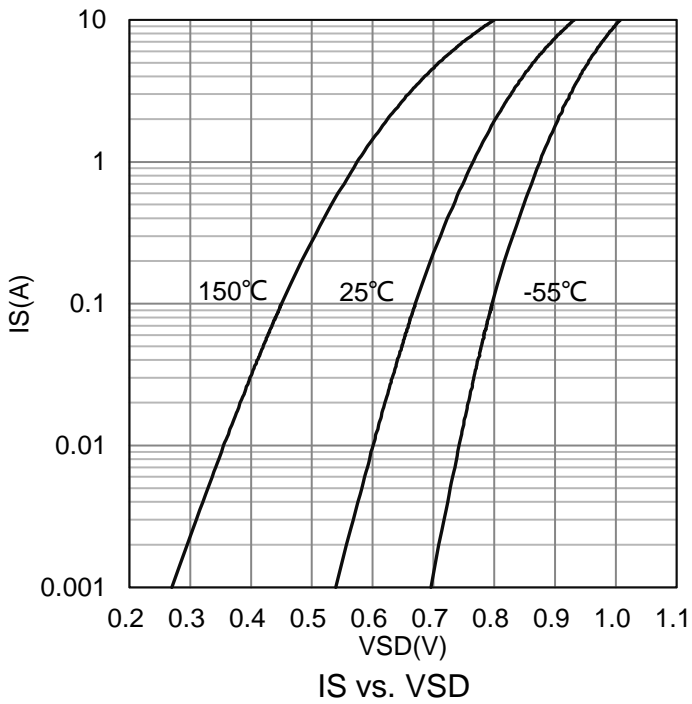
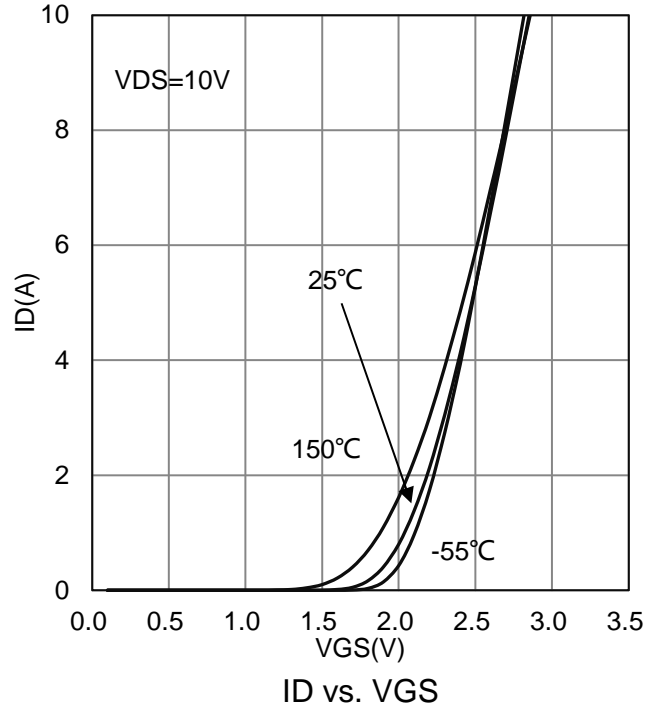
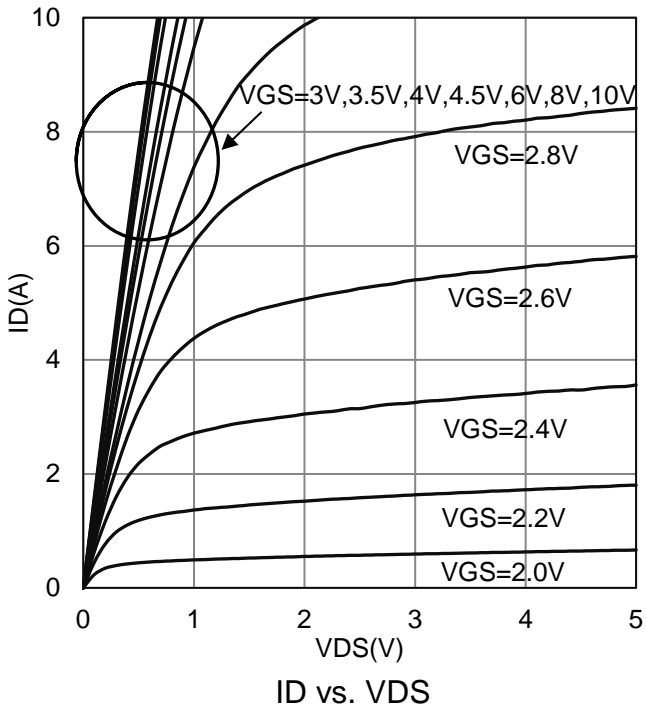

7. ELECTRICAL CHARACTERISTICS CURVES(Con.)

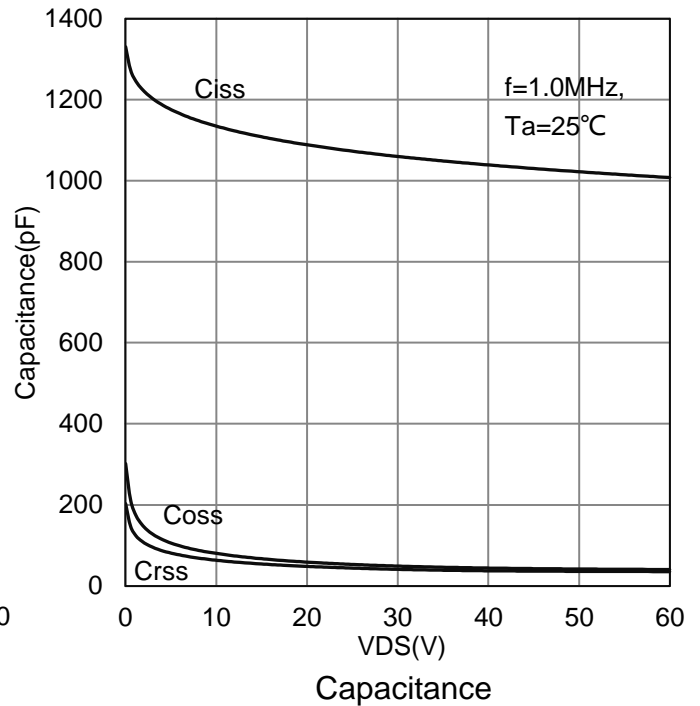
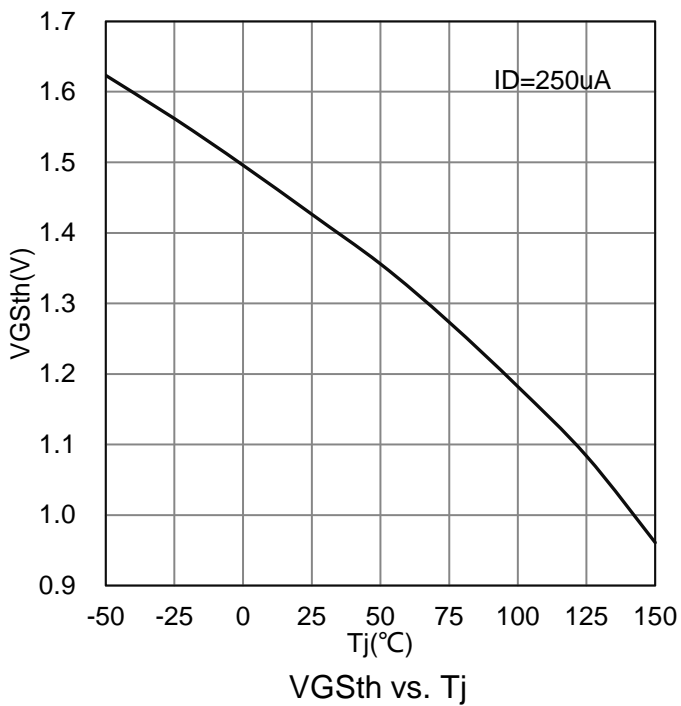
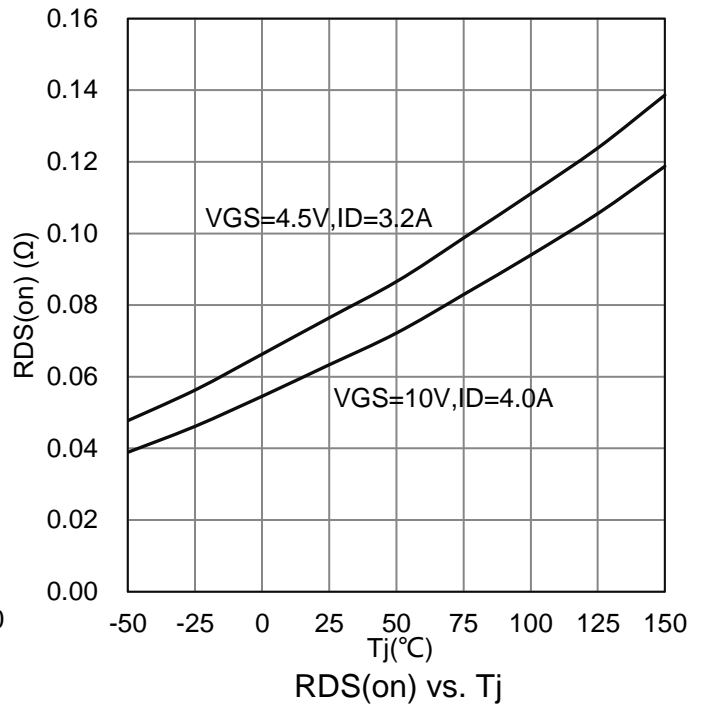
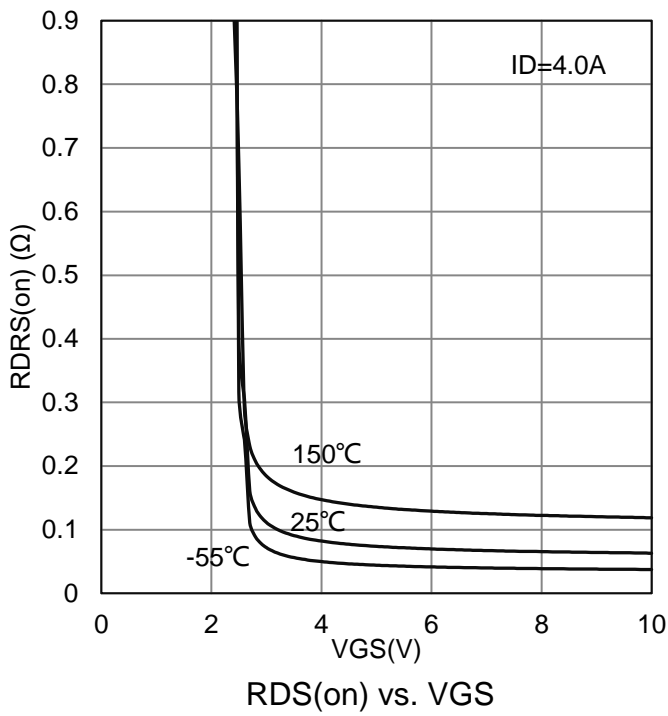

8. OUTLINE AND DIMENSIONS

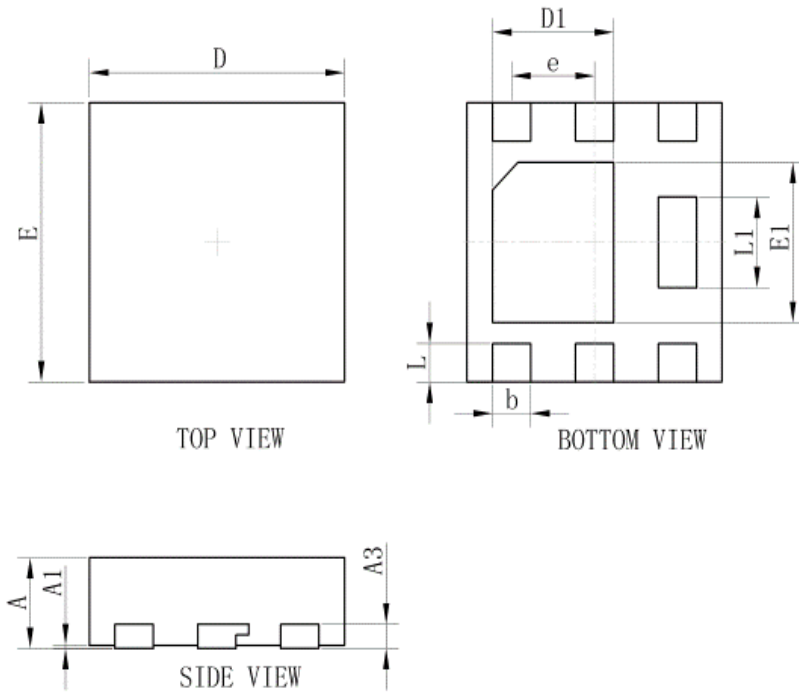

DFN2020-6S			
DIM	MIN	NOR	MAX
A	0.60	0.65	0.70
A1	0.01	0.03	0.05
b	0.25	0.30	0.35
D	1.95	2.00	2.05
E	1.95	2.00	2.05
e	0.65TYP.		
L	0.23	0.28	0.33
L1	0.60	0.65	0.65
D1	0.90	0.95	1.00
E1	1.10	1.15	1.20
A3	0.152REF		
All Dimensions in mm			

9. SOLDERING FOOTPRINT

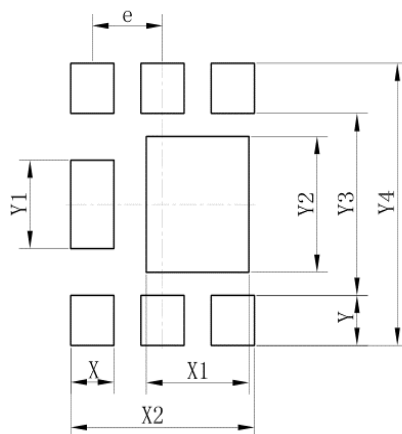

DFN2020-6S	
Dim	(mm)
X	0.40
X1	0.95
X2	1.70
e	0.65
Y	0.43
Y1	0.75
Y2	1.15
Y3	1.54
Y4	2.39

DISCLAIMER

- Before you use our Products, you are requested to carefully read this document and fully understand its contents. LRC shall not be in any way responsible or liable for failure, malfunction or accident arising from the use of any LRC's Products against warning, caution or note contained in this document.
- All information contained in this document is current as of the issuing date and subject to change without any prior notice. Before purchasing or using LRC's Products, please confirm the latest information with a LRC sales representative.