

Surface Mount General Purpose Silicon Rectifiers

Reverse Voltage - 50 to 1000 V

Forward Current - 3 A

FEATURES

- For surface mounted applications
- Low profile package
- Glass Passivated Chip Junction
- Easy to pick and place
- Lead free in comply with EU RoHS 2011/65/EU directives

MECHANICAL DATA

- Case: SMB
- Terminals: Solderable per MIL-STD-750, Method 2026
- Approx. Weight: 0.055g / 0.002oz

PINNING

- 1 Cathode
- 2 Anode



Top View
Marking Code : S5A~S5M
Simplified outline SMB and symbol

Maximum Ratings and Electrical characteristics

Ratings at 25 °C ambient temperature unless otherwise specified.

Single phase half-wave 60 Hz, resistive or inductive load, for capacitive load current derate by 20 %.

Parameter	Symbols	S3AB	S3BB	S3DB	S3GB	S3JB	S3KB	S3MB	Units
Maximum Repetitive Peak Reverse Voltage	V_{RRM}	50	100	200	400	600	800	1000	V
Maximum RMS voltage	V_{RMS}	35	70	140	280	420	560	700	V
Maximum DC Blocking Voltage	V_{DC}	50	100	200	400	600	800	1000	V
Maximum Average Forward Rectified Current	$I_{F(AV)}$	3							A
Peak Forward Surge Current 8.3 ms Single Half Sine Wave Superimposed on Rated Load	I_{FSM}	90							A
Maximum Instantaneous Forward Voltage at 3 A	V_F	1.1							V
Maximum DC Reverse Current at Rated DC Blocking Voltage	I_R	5 100							μA
Typical Junction Capacitance ⁽¹⁾	C_j	35							pF
Typical Thermal Resistance ⁽²⁾	$R_{\theta JA}$ $R_{\theta JC}$	48 16							°C/W
Operating and Storage Temperature Range	T_j, T_{stg}	-55 ~ +150							°C

(1) Measured at 1 MHz and applied reverse voltage of 4 V D.C

(2) P.C.B. mounted with 2.0" X 2.0" (5 X 5 cm) copper pad areas.

Fig.1 Forward Current Derating Curve

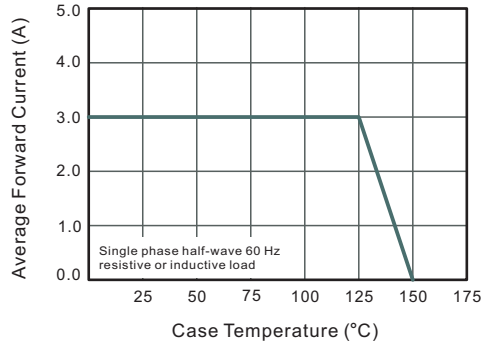

Fig.2 Typical Instantaneous Reverse Characteristics

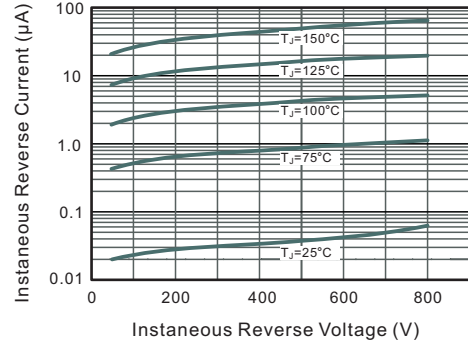

Fig.3 Typical Forward Characteristic

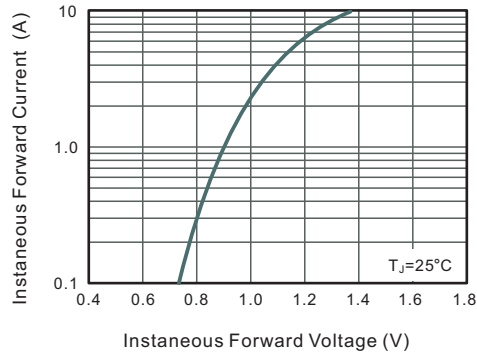

Fig.4 Typical Junction Capacitance

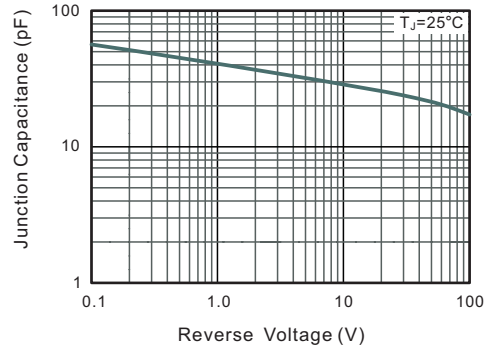
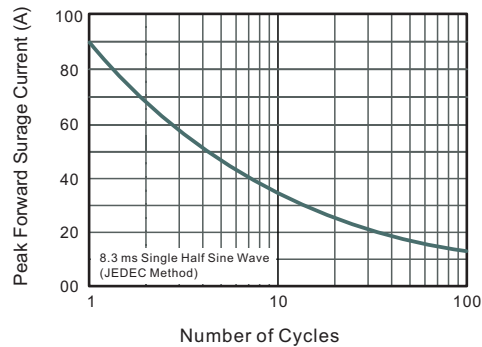

Fig.5 Maximum Non-Repetitive Peak Forward Surge Current



PACKAGE OUTLINE

Plastic surface mounted package; 2 leads

SMB

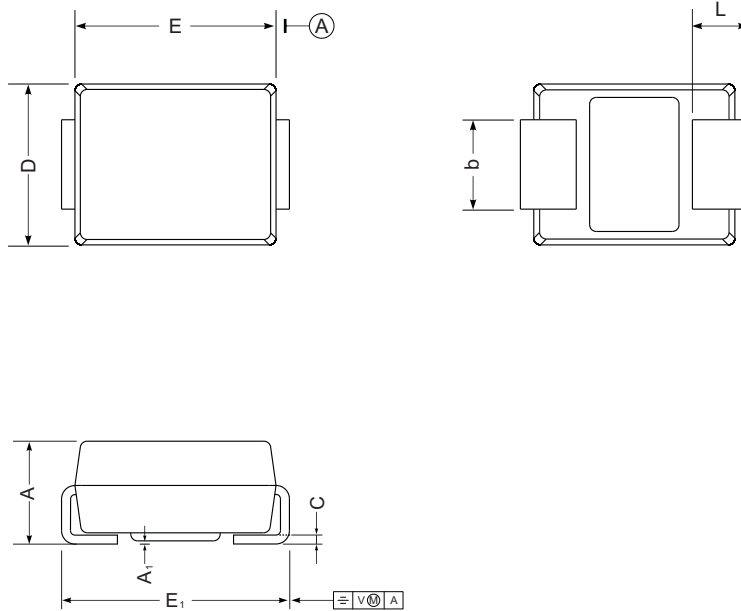

SMB mechanical data

UNIT		A	E	D	E ₁	A ₁	L	C	b
mm	max	2.44	4.70	3.94	5.59	0.20	1.5	0.305	2.2
	min	2.13	4.06	3.3	5.08	0.05	0.8	0.152	1.9
mil	max	96	185	155	220	7.9	59	12	87
	min	84	160	130	200	2.0	32	6	75

The recommended mounting pad size

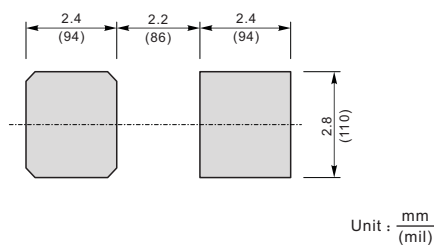

Marking

Type number	Marking code
S3AB	S3A
S3BB	S3B
S3DB	S3D
S3GB	S3G
S3JB	S3J
S3KB	S3K
S3MB	S3M