

### 1.5KE Series



#### Agency Approvals

Agency	Agency File Number
	E230531

#### Maximum Ratings and Thermal Characteristics (T<sub>A</sub> = 25°C unless otherwise noted)

Parameter	Symbol	Value	Unit
Peak Pulse Power Dissipation (Fig.2) by 10/1000µs Test Waveform (Fig.4) (Note 1) -Single Die Parts	P <sub>PPM</sub>	1500	W
Peak Pulse Power Dissipation(Fig.2) by 10/1000µs Test Waveform(Fig.4)(Note 1) -Stacked Die Parts (Note 4)	P <sub>PPM</sub>	2000	W
Steady State Power Dissipation on Infinite Heat Sink at T <sub>L</sub> = 75°C	P <sub>D</sub>	6.5	W
Peak Forward Surge Current, 8.3ms Single Half Sine Wave Unidirectional Only (Note 2)	I <sub>FSM</sub>	200	A
Maximum Instantaneous Forward Voltage at 100A for Unidirectional Only (Note 3)	V <sub>F</sub>	3.5/5.0	V
Operating Junction and Storage Temperature Range	T <sub>J</sub> , T <sub>STG</sub>	-55 to 175	°C
Typical Thermal Resistance Junction to Lead	R <sub>θJL</sub>	15	°C/W
Typical Thermal Resistance Junction to Ambient	R <sub>θJA</sub>	75	°C/W

- Notes:**
1. Non-repetitive current pulse, per Fig. 4 and derated above T<sub>J</sub> (initial) = 25°C per Fig. 3.
  2. Measured on 8.3ms single half sine wave or equivalent square wave, duty cycle=4 per minute maximum.
  3. V<sub>F</sub> < 3.5V for single die parts and V<sub>F</sub> < 5.0V for stacked-die parts.
  4. For stacked die component details, please refer to part numbers labeled by \* in Electrical Characteristics.

#### Functional Diagram

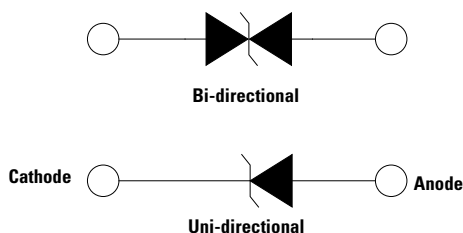

#### Description

The 1.5KE Series is designed specifically to protect sensitive electronic equipment from voltage transients induced by lightning and other transient voltage events.

#### Features

- 1500W peak pulse capability at 10/1000µs waveform, repetition rate (duty cycles):0.01 %
- Glass passivated chip junction in DO-201 Package
- Fast response time: typically less than 1.0ps from 0 Volts to BV min
- Excellent clamping capability
- Typical failure mode is short from over-specified voltage or current
- Whisker test is conducted based on JEDEC JESD201A per its table 4a and 4c
- IEC-61000-4-2 ESD 30kV(Air), 30kV (Contact)
- ESD protection of data lines in accordance with IEC 61000-4-2
- EFT protection of data lines in accordance with IEC 61000-4-4
- Low incremental surge resistance
- Typical I<sub>R</sub> less than 1µA when V<sub>BR</sub> min > 12V
- High temperature to reflow soldering guaranteed: 260°C/30sec / 0.375”(9.5mm) lead length, 5 lbs., (2.3kg) tension
- V<sub>BR</sub> @ T<sub>J</sub> = V<sub>BR</sub> @ 25°C x (1 + αT x (T<sub>J</sub> - 25)) (αT: Temperature Coefficient, typical value is 0.1%)
- Plastic package is flammability rated V-0 per Underwriters Laboratories
- Matte tin lead-free plated
- Halogen free and RoHS compliant
- Pb-free E3 means 2nd level interconnect is Pb-free and the terminal finish material is tin(Sn) (IPC/JEDEC J-STD-609A.01)

#### Applications

TVS devices are ideal for the protection of I/O interfaces, V<sub>CC</sub> bus and other vulnerable circuits used in telecom, computer, industrial and consumer electronic applications.

#### Additional Information



### Electrical Characteristics (T<sub>A</sub>=25°C unless otherwise noted)

Part Number (Uni)	Part Number (Bi)	Reverse Stand off Voltage V <sub>R</sub> (Volts)	Breakdown Voltage V <sub>BR</sub> (Volts) @ I <sub>T</sub>		Test Current I <sub>T</sub> (mA)	Maximum Clamping Voltage V <sub>C</sub> @ I <sub>PP</sub> (Volts)	Maximum Peak Pulse Current I <sub>PP</sub> (A)	Maximum Reverse Leakage I <sub>R</sub> @ V <sub>R</sub> (µA)	Agency Approval 
			Min.	Max.					
1.5KE6.8A	1.5KE6.8CA	5.80	6.45	7.14	10	10.5	144.8	1000	X
1.5KE7.5A	1.5KE7.5CA	6.40	7.13	7.88	10	11.3	134.5	500	X
1.5KE8.2A	1.5KE8.2CA	7.02	7.79	8.61	10	12.1	125.6	200	X
1.5KE9.1A	1.5KE9.1CA	7.78	8.65	9.50	1	13.4	113.4	50	X
1.5KE10A	1.5KE10CA	8.55	9.50	10.50	1	14.5	104.8	10	X
1.5KE11A	1.5KE11CA	9.40	10.50	11.60	1	15.6	97.4	5	X
1.5KE12A	1.5KE12CA	10.20	11.40	12.60	1	16.7	91.0	5	X
1.5KE13A	1.5KE13CA	11.10	12.40	13.70	1	18.2	83.5	1	X
1.5KE15A	1.5KE15CA	12.80	14.30	15.80	1	21.2	71.7	1	X
1.5KE16A	1.5KE16CA	13.60	15.20	16.80	1	22.5	67.6	1	X
1.5KE18A	1.5KE18CA	15.30	17.10	18.90	1	25.2	60.3	1	X
1.5KE20A	1.5KE20CA	17.10	19.00	21.00	1	27.7	54.9	1	X
1.5KE22A	1.5KE22CA	18.80	20.90	23.10	1	30.6	49.7	1	X
1.5KE24A	1.5KE24CA	20.50	22.80	25.20	1	33.2	45.8	1	X
1.5KE27A	1.5KE27CA	23.10	25.70	28.40	1	37.5	40.5	1	X
1.5KE30A	1.5KE30CA	25.60	28.50	31.50	1	41.4	36.7	1	X
1.5KE33A	1.5KE33CA	28.20	31.40	34.70	1	45.7	33.3	1	X
1.5KE36A	1.5KE36CA	30.80	34.20	37.80	1	49.9	30.5	1	X
1.5KE39A	1.5KE39CA	33.30	37.10	41.00	1	53.9	28.2	1	X
1.5KE43A	1.5KE43CA	36.80	40.90	45.20	1	59.3	25.6	1	X
1.5KE47A	1.5KE47CA	40.20	44.70	49.40	1	64.8	23.5	1	X
1.5KE51A	1.5KE51CA	43.60	48.50	53.60	1	70.1	21.7	1	X
1.5KE56A	1.5KE56CA	47.80	53.20	58.80	1	77.0	19.7	1	X
1.5KE62A	1.5KE62CA	53.00	58.90	65.10	1	85.0	17.9	1	X
1.5KE68A	1.5KE68CA	58.10	64.60	71.40	1	92.0	16.5	1	X
1.5KE75A	1.5KE75CA	64.10	71.30	78.80	1	103.0	14.8	1	X
1.5KE82A	1.5KE82CA	70.10	77.90	86.10	1	113.0	13.5	1	X
1.5KE91A	1.5KE91CA	77.80	86.50	95.50	1	125.0	12.2	1	X
1.5KE100A	1.5KE100CA	85.50	95.00	105.00	1	137.0	11.1	1	X
1.5KE110A	1.5KE110CA	94.00	105.00	116.00	1	152.0	10.0	1	X
1.5KE120A	1.5KE120CA	102.00	114.00	126.00	1	165.0	9.2	1	X
1.5KE130A	1.5KE130CA	111.00	124.00	137.00	1	179.0	8.5	1	X
1.5KE150A	1.5KE150CA	128.00	143.00	158.00	1	207.0	7.3	1	X
1.5KE160A	1.5KE160CA	136.00	152.00	168.00	1	219.0	6.9	1	X
1.5KE170A	1.5KE170CA	145.00	162.00	179.00	1	234.0	6.5	1	X
1.5KE180A	1.5KE180CA	154.00	171.00	189.00	1	246.0	6.2	1	X
1.5KE200A	1.5KE200CA	171.00	190.00	210.00	1	274.0	5.5	1	X
1.5KE220A	1.5KE220CA	185.00	209.00	231.00	1	328.0	4.6	1	X
1.5KE250A	-	214.00	237.00	263.00	1	344.0	4.4	1	X
-	1.5KE250CA*	214.00	237.00	263.00	1	344.0	5.9	1	X
1.5KE300A*	1.5KE300CA*	256.00	285.00	315.00	1	414.0	4.9	1	X
1.5KE320A*	1.5KE320CA*	273.00	304.00	336.00	1	441.0	4.6	1	X
1.5KE350A*	1.5KE350CA*	300.00	332.00	368.00	1	482.0	4.2	1	X
1.5KE400A*	1.5KE400CA*	342.00	380.00	420.00	1	548.0	3.7	1	X
1.5KE440A*	1.5KE440CA*	376.00	418.00	462.00	1	602.0	3.1	1	X
1.5KE480A*	1.5KE480CA*	408.00	456.00	504.00	1	658.0	3.1	1	-
1.5KE510A*	1.5KE510CA*	434.00	485.00	535.00	1	698.0	2.9	1	-
1.5KE530A*	1.5KE530CA*	451.00	503.50	556.50	1	725.0	2.8	1	-
1.5KE540A*	1.5KE540CA*	460.00	513.00	567.00	1	740.0	2.8	1	-
1.5KE550A*	1.5KE550CA*	468.00	522.50	577.50	1	760.0	2.7	1	-
1.5KE600A*	1.5KE600CA*	512.00	570.00	630.00	1	828.0	2.5	1	-

For bidirectional type having V<sub>R</sub> of 10 volts and less, the I<sub>R</sub> limit is double.

For parts without A, the V<sub>BR</sub> is ± 10% and V<sub>C</sub> is 5% higher than with A parts, the parts without A are currently available, but not recommended for new designs. The parts with A are preferred.

For stack-die parts, use \* to label the part number.

**I-V Curve Characteristics**

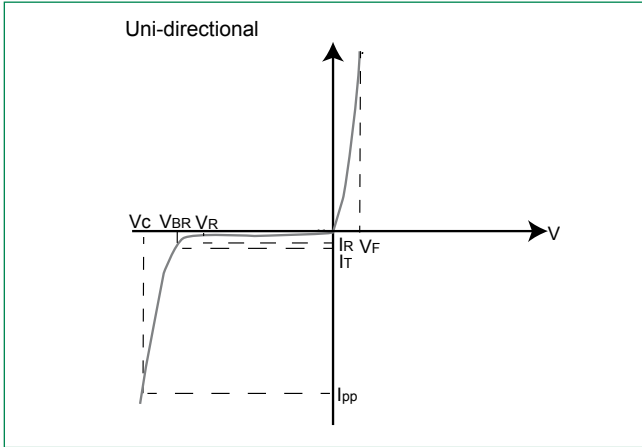

- $P_{PPM}$  Peak Pulse Power Dissipation** – Max power dissipation
- $V_R$  Stand-off Voltage** – Maximum voltage that can be applied to the TVS without operation
- $V_{BR}$  Breakdown Voltage** – Maximum voltage that flows through the TVS at a specified test current ( $I_r$ )
- $V_C$  Clamping Voltage** – Peak voltage measured across the TVS at a specified  $I_{ppm}$  (peak impulse current)
- $I_R$  Reverse Leakage Current** – Current measured at  $V_R$
- $V_F$  Forward Voltage Drop for Uni-directional**

**Ratings and Characteristic Curves** ( $T_A=25^\circ\text{C}$  unless otherwise noted)

**Figure 1 - TVS Transients Clamping Waveform**

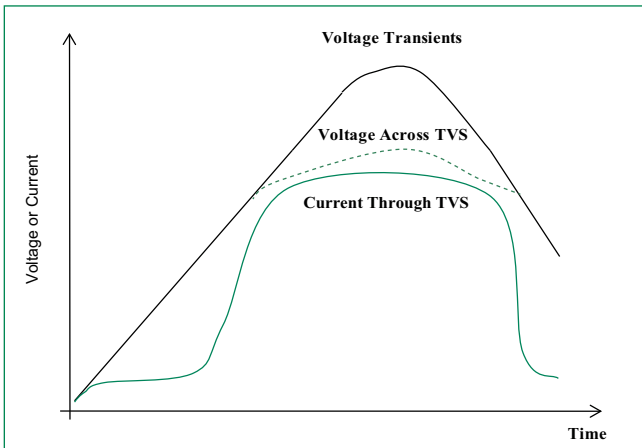
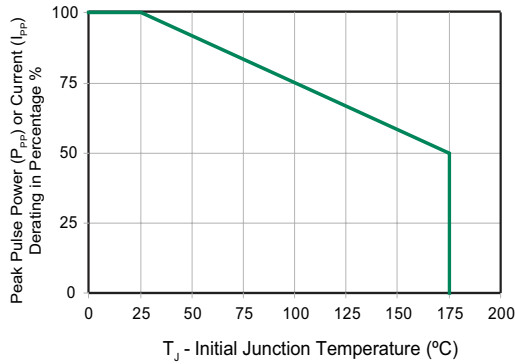

**Figure 2 - Peak Pulse Power Rating**



**Ratings and Characteristic Curves** ( $T_A=25^\circ\text{C}$  unless otherwise noted) (Continued)

**Figure 3 - Peak Pulse Power Derating Curve**



**Figure 4 - Pulse Waveform**

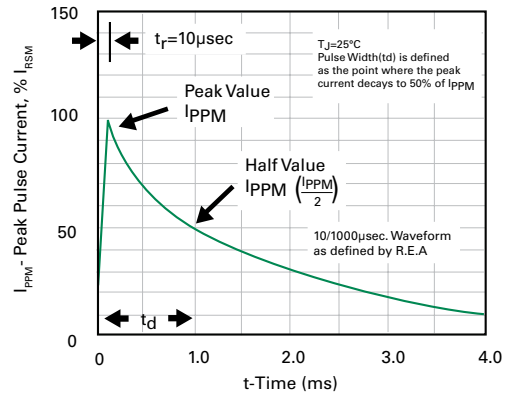

**Figure 5 - Typical Junction Capacitance**

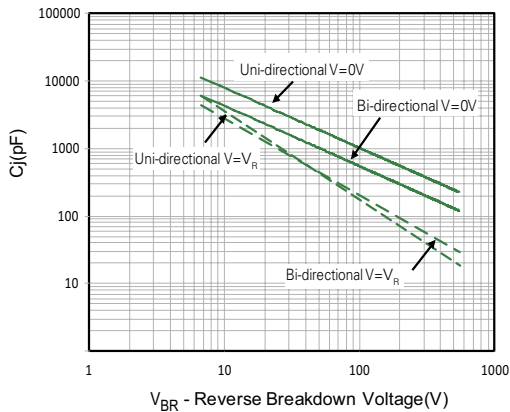

**Figure 6 - Typical Transient Thermal Impedance**

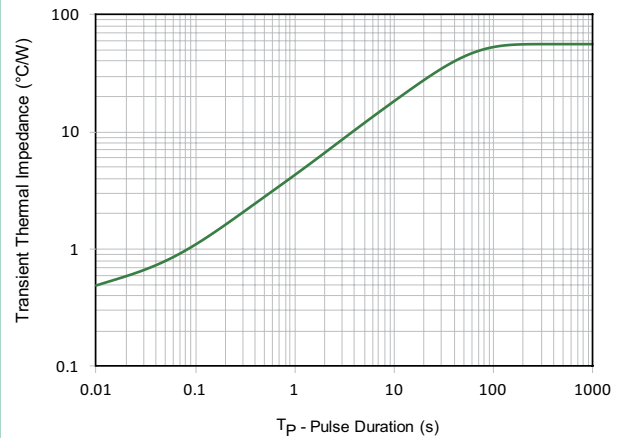

**Figure 7 - Maximum Non-Repetitive Peak Forward Surge Current Uni-Directional Only**

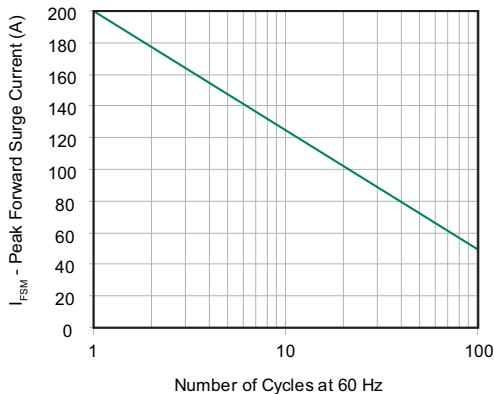

**Figure 8 - Peak Forward Voltage Drop vs Peak Forward Current (Typical Values)**

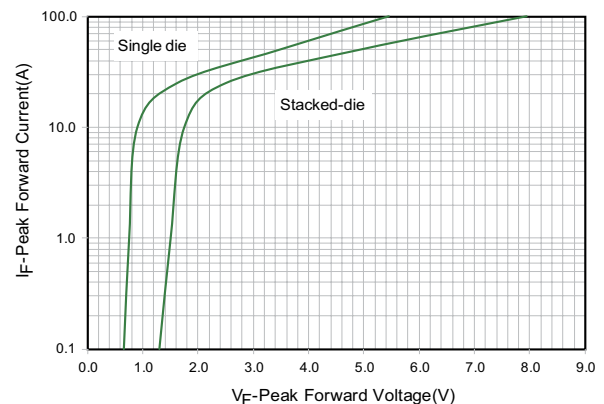

### Soldering Parameters

<b>Reflow Condition</b>		Lead-free assembly
<b>Pre Heat</b>	- Temperature Min ( $T_{s(min)}$ )	150°C
	- Temperature Max ( $T_{s(max)}$ )	200°C
	- Time (min to max) ( $t_s$ )	60 – 120 secs
<b>Average ramp up rate (Liquidus Temp (<math>T_L</math>) to peak)</b>		3°C/second max
<b><math>T_{s(max)}</math> to <math>T_L</math> - Ramp-up Rate</b>		3°C/second max
<b>Reflow</b>	- Temperature ( $T_L$ ) (Liquidus)	217°C
	- Time (min to max) ( $t_L$ )	60 – 150 seconds
<b>Peak Temperature (<math>T_p</math>)</b>		260 <sup>+0/-5</sup> °C
<b>Time within 5°C of actual peak Temperature (<math>t_p</math>)</b>		30 seconds max
<b>Ramp-down Rate</b>		6°C/second max
<b>Time 25°C to peak Temperature (<math>T_p</math>)</b>		8 minutes Max.
<b>Do not exceed</b>		260°C



### Flow/Wave Soldering (Solder Dipping)

<b>Peak Temperature :</b>	265°C
<b>Dipping Time :</b>	10 seconds
<b>Soldering :</b>	1 time

### Physical Specifications

<b>Weight</b>	0.045oz., 1.2g
<b>Case</b>	JEDEC DO-201 molded plastic body over passivated junction.
<b>Polarity</b>	Color band denotes the cathode except Bipolar.
<b>Terminal</b>	Matte Tin axial leads, solderable per JESD22-B102.

### Environmental Specifications

<b>High Temp. Storage</b>	JESD22-A103
<b>HTRB</b>	JESD22-A108
<b>Temperature Cycling</b>	JESD22-A104
<b>H3TRB</b>	JESD22-A101
<b>RSH</b>	JESD22-B106

### Dimensions

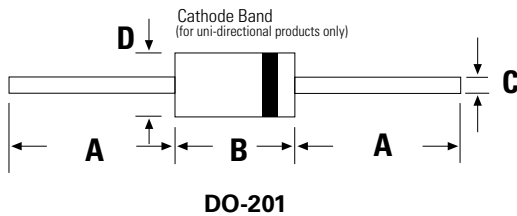

Dimensions	Inches		Millimeters	
	Min	Max	Min	Max
<b>A</b>	1.000	-	25.40	-
<b>B</b>	0.285	0.375	7.20	9.50
<b>C</b>	0.038	0.042	0.96	1.07
<b>D</b>	0.190	0.210	4.80	5.30

### Part Numbering System

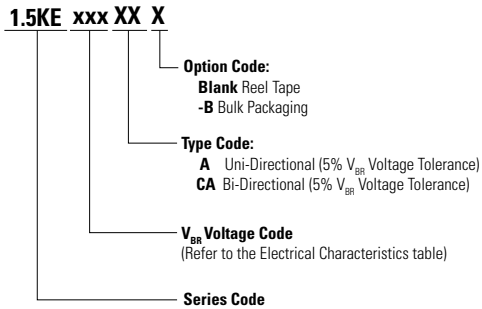

### Part Marking System

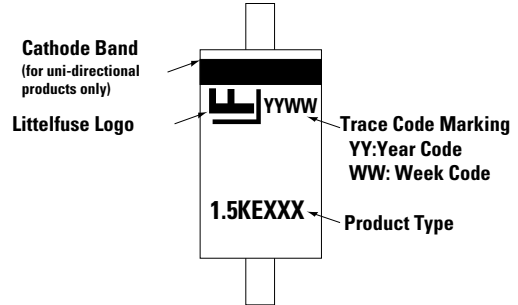

### Packaging

Part Number	Component Package	Quantity	Packaging Option	Packaging Specification
1.5KExxxXX	DO-201	1200	Tape & Reel	EIA STD RS-296
1.5KExxxXX-B	DO-201	500	BULK	Littelfuse Spec.

### Tape and Reel Specification

