

| 修 订 | 标 记 | 修 改 描 要 | 签 名 | 日 期 |
|-----|------|----------------------|-----------|------------|
| REV | MARK | REVISION DESCRIPTION | SIGNATURE | DATE |
| AO | | NEW DWG | | 2016-03-12 |

NOTE:



一、 MATERIALS:

1. Housing: PBT BLACK.
2. Cover: PA66 BLACK.
3. Contacts: Brass
4. Shell: SPCC
5. Board Lock: SPCC
6. Rivet: Copper Alloy
7. Screw: SPCC

二、 FINISH:

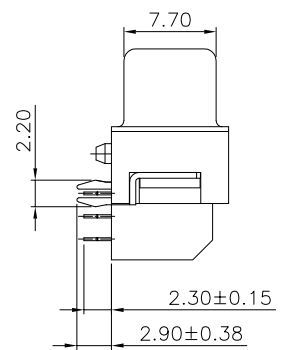
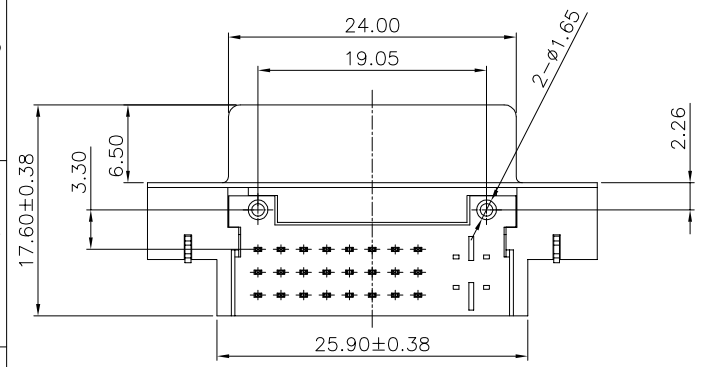
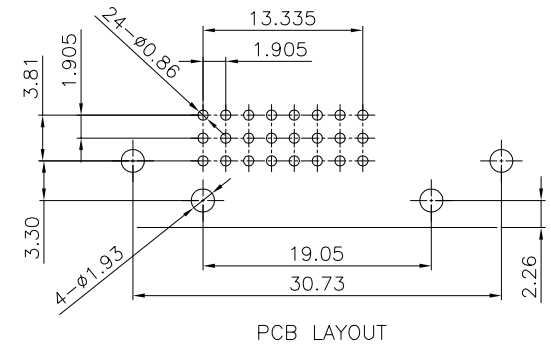
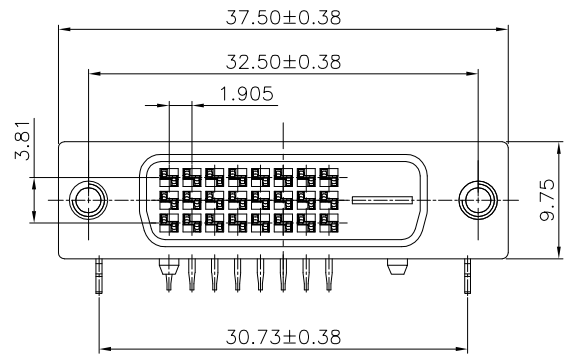
1. Contacts: Gold Plated on Contact Area
Sn Plated on Solderails
Nickel Under Plated Over All
2. Shell: Black Nickel Plated
3. Board Lock: Sn Plated
4. Rivet: Nickel Plated
5. Screw: Nickel Plated



| | | | | | | | | |
|---|-------|--|-----|---|---------------------------------|--------------------------------|------|-------------|
|  | | 深圳市华德共创科技有限公司 Shenzhen Huade co-create Technology Co.,LTD 电话: 0755-23304126 传真: 0755-29940187 | | | | | | |
| | | -TOLERANCES- UNLESS OTHERWISE SPECIFIED 公差参数表 | |   | | TITLE: 产品名称: DVI 24+1母座不带螺丝 | | |
| X.X | ±0.30 | X.X* | ±3° | APPD: 核准: | PART NO: 产品编号: DVI-HX-105DIP | | | |
| X.XX | ±0.20 | X.XX* | ±2° | CHECK: 校对: 王建业 | DATE | SCALE | UNIT | CODE NUMBER |
| X.XXX | ±0.10 | X.XXX* | ±1° | DRAW: 绘图: 黄艳兰 | 2016-03-12 | 1:1 | mm | A001 |