

BSCQ Series



BSCQ Series supports miniaturized devices. Its low inductance, high precision and high Q enables easy impedance matching at both RF and IF circuits and compact high frequency circuit designing.

Features

- Excellent high frequency application
- High Q factor and SRF value
- Miniaturization
- Tight tolerance
- Wide inductance range

Applications

- RF matching circuit requiring Q value
- Bluetooth, WLAN, UWB, digital TV tuners and high-frequency circuit and module

Product Identification

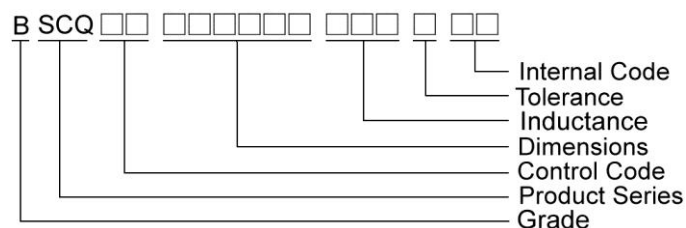

Shape and Dimensions

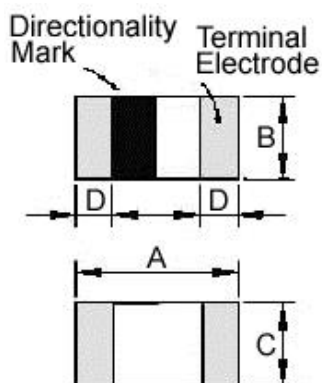

Dimensions in mm

TYPE	A	B	C	D
BSCQ00060303	0.6±0.03	0.3±0.03	0.3±0.03	0.15±0.05

Recommended Pattern

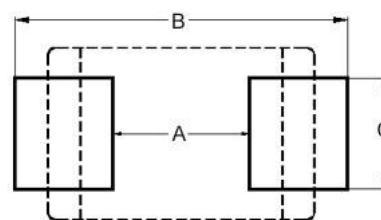

Dimensions in mm

TYPE	A	B	C
BSCQ00060303	0.3	0.75 ~ 1.05	0.3

SMD Ceramic Multilayer Chip Inductors – BSCQ Series

Electrical Characteristics

Part Number	Inductance (nH)	Tolerance (±%)	Q Min	Test Freq. (MHz)	Q Typical					SRF (MHz) Min	RDC (Ω) Max	IDC (mA) Max
					500 MHz	800 MHz	1.8 GHz	2.0 GHz	2.4 GHz			
BSCQ000603030N6□00	0.6	±0.1nH/±0.2nH/±0.3nH	14	500	>24	>32	>54	>57	>65	10000	0.06	900
BSCQ000603030N7□00	0.7	±0.1nH/±0.2nH/±0.3nH	14	500	>24	>32	>54	>57	>65	10000	0.06	900
BSCQ000603030N8□00	0.8	±0.1nH/±0.2nH/±0.3nH	14	500	>24	>32	>54	>57	>65	10000	0.06	900
BSCQ000603030N9□00	0.9	±0.1nH/±0.2nH/±0.3nH	14	500	>24	>32	>54	>57	>65	10000	0.06	900
BSCQ000603031N0□00	1.0	±0.1nH/±0.2nH/±0.3nH	14	500	23	32	54	57	65	10000	0.07	850
BSCQ000603031N1□00	1.1	±0.1nH/±0.2nH/±0.3nH	14	500	22	26	45	47	55	10000	0.07	850
BSCQ000603031N2□00	1.2	±0.1nH/±0.2nH/±0.3nH	14	500	22	25	43	44	52	10000	0.08	800
BSCQ000603031N3□00	1.3	±0.1nH/±0.2nH/±0.3nH	14	500	19	25	40	42	47	10000	0.09	760
BSCQ000603031N4□00	1.4	±0.1nH/±0.2nH/±0.3nH	14	500	19	24	339	41	47	10000	0.12	640
BSCQ000603031N5□00	1.5	±0.1nH/±0.2nH/±0.3nH	14	500	19	24	39	41	46	10000	0.15	600
BSCQ000603031N6□00	1.6	±0.1nH/±0.2nH/±0.3nH	14	500	19	24	39	41	46	10000	0.19	510
BSCQ000603031N7□00	1.7	±0.1nH/±0.2nH/±0.3nH	14	500	19	24	39	41	46	10000	0.11	680
BSCQ000603031N8□00	1.8	±0.1nH/±0.2nH/±0.3nH	14	500	19	24	39	41	46	10000	0.12	640
BSCQ000603031N9□00	1.9	±0.1nH/±0.2nH/±0.3nH	14	500	18	24	38	40	45	10000	0.13	620
BSCQ000603032N0□00	2.0	±0.1nH/±0.2nH/±0.3nH	14	500	17	24	38	39	44	10000	0.15	600
BSCQ000603032N1□00	2.1	±0.1nH/±0.2nH/±0.3nH	14	500	17	24	37	39	44	10000	0.16	550
BSCQ000603032N2□00	2.2	±0.1nH/±0.2nH/±0.3nH	14	500	17	24	38	40	43	10000	0.20	500
BSCQ000603032N3□00	2.3	±0.1nH/±0.2nH/±0.3nH	14	500	17	24	37	39	43	10000	0.24	460
BSCQ000603032N4□00	2.4	±0.1nH/±0.2nH/±0.3nH	14	500	17	23	36	38	42	10000	0.26	430
BSCQ000603032N5□00	2.5	±0.1nH/±0.2nH/±0.3nH	14	500	17	23	35	36	40	10000	0.28	415
BSCQ000603032N6□00	2.6	±0.1nH/±0.2nH/±0.3nH	14	500	17	22	34	35	39	10000	0.30	405
BSCQ000603032N7□00	2.7	±0.1nH/±0.2nH/±0.3nH	14	500	17	22	34	35	39	10000	0.32	400
BSCQ000603032N8□00	2.8	±0.1nH/±0.2nH/±0.3nH	14	500	17	22	34	35	39	9500	0.20	500
BSCQ000603032N9□00	2.9	±0.1nH/±0.2nH/±0.3nH	14	500	17	22	34	35	39	9300	0.22	480
BSCQ000603033N0□00	3.0	±0.1nH/±0.2nH/±0.3nH	14	500	17	22	34	35	39	9100	0.24	460
BSCQ000603033N1□00	3.1	±0.1nH/±0.2nH/±0.3nH	14	500	17	22	34	35	39	8900	0.25	450
BSCQ000603033N2□00	3.2	±0.1nH/±0.2nH/±0.3nH	14	500	17	22	33	35	39	8700	0.28	415
BSCQ000603033N3□00	3.3	±0.1nH/±0.2nH/±0.3nH	14	500	18	23	34	36	40	8600	0.28	415
BSCQ000603033N4□00	3.4	±0.1nH/±0.2nH/±0.3nH	14	500	17	23	33	35	39	8400	0.29	410
BSCQ000603033N5□00	3.5	±0.1nH/±0.2nH/±0.3nH	14	500	17	23	33	35	39	8200	0.30	405
BSCQ000603033N6□00	3.6	±0.1nH/±0.2nH/±0.3nH	14	500	16	23	33	35	39	8100	0.32	400
BSCQ000603033N7□00	3.7	±0.1nH/±0.2nH/±0.3nH	14	500	16	23	33	35	38	8000	0.36	370
BSCQ000603033N8□00	3.8	±0.1nH/±0.2nH/±0.3nH	14	500	16	22	33	35	38	7800	0.40	355
BSCQ000603033N9□00	3.9	±0.1nH/±0.2nH/±0.3nH	14	500	16	22	33	35	38	7700	0.41	350

Note: When ordering, please specify tolerance code. Tolerance : B=±0.1nH , C=±0.2nH , S=±0.3nH , H=±3% , J=±5%

- Operating temperature range - 55°C ~ 125°C(Including self - temperature rise)
- IDC : Applied the current to coils, the inductance shall be less than 10% initial value
- Residual impedance of short chip : 0.48nH
- Measure Equipment :

L & Q : Agilent E4991A+Agilent 16197A

SRF : Agilent E4991A or HP19196C

RDC : HP4338B or CHEN HWA 502

Please be sure to request approval specifications that provide further details of the products. Kindly note that the content of these specifications are subject to change or may be discontinued without prior notice. This product may not be designed/used in medical or high risk applications without Chilisin approval. Please contact our sales department before ordering.

SMD Ceramic Multilayer Chip Inductors – BSCQ Series

Electrical Characteristics

Part Number	Inductance (nH)	Tolerance (±%)	Q Min	Test Freq. (MHz)	Q Typical					SRF (MHz) Min	RDC (Ω) Max	IDC (mA) Max
					500 MHz	800 MHz	1.8 GHz	2.0 GHz	2.4 GHz			
BSCQ000603034N3□00	4.3	±0.2nH/±0.3nH	14	500	16	21	32	34	37	6500	0.48	320
BSCQ000603034N7□00	4.7	±0.2nH/±0.3nH	14	500	16	22	33	35	38	6400	0.42	350
BSCQ000603035N1□00	5.1	±0.2nH/±0.3nH	14	500	17	22	34	36	38	6100	0.45	330
BSCQ000603035N6□00	5.6	±0.2nH/±0.3nH	14	500	16	21	33	34	37	5500	0.47	325
BSCQ000603036N2□00	6.2	±0.2nH/±0.3nH	14	500	18	23	34	35	37	5100	0.52	305
BSCQ000603036N8□00	6.8	3 / 5	14	500	17	22	32	33	35	4800	0.55	305
BSCQ000603037N5□00	7.5	3 / 5	14	500	16	21	31	33	34	4600	0.55	305
BSCQ000603038N2□00	8.2	3 / 5	14	500	16	21	31	32	34	4300	0.57	290
BSCQ000603039N1□00	9.1	3 / 5	14	500	16	20	30	31	32	4000	0.65	270
BSCQ0006030310N□00	10	3 / 5	14	500	16	20	28	29	31	3800	0.85	230
BSCQ0006030312N□00	12	3 / 5	12	500	16	20	27	28	28	3300	0.85	230
BSCQ0006030315N□00	15	3 / 5	12	500	15	19	24	24	23	2600	0.89	220
BSCQ0006030318N□00	18	3 / 5	12	500	15	19	23	24	22	2300	1.05	205
BSCQ0006030322N□00	22	3 / 5	12	500	15	19	22	23	20	1900	1.29	190

Note: When ordering, please specify tolerance code. Tolerance : B=±0.1nH , C=±0.2nH , S=±0.3nH , H=±3% , J=±5%

- Operating temperature range - 55°C ~ 125°C(Including self - temperature rise)
- IDC : Applied the current to coils, the inductance shall be less than 10% initial value
- Residual impedance of short chip : 0.48nH
- Measure Equipment :
 L & Q : Agilent E4991A+Agilent 16197A
 SRF : Agilent E4991A or HP19196C
 RDC : HP4338B or CHEN HWA 502

Test Instruments : Agilent E4991A Material/Impedance Analyzer

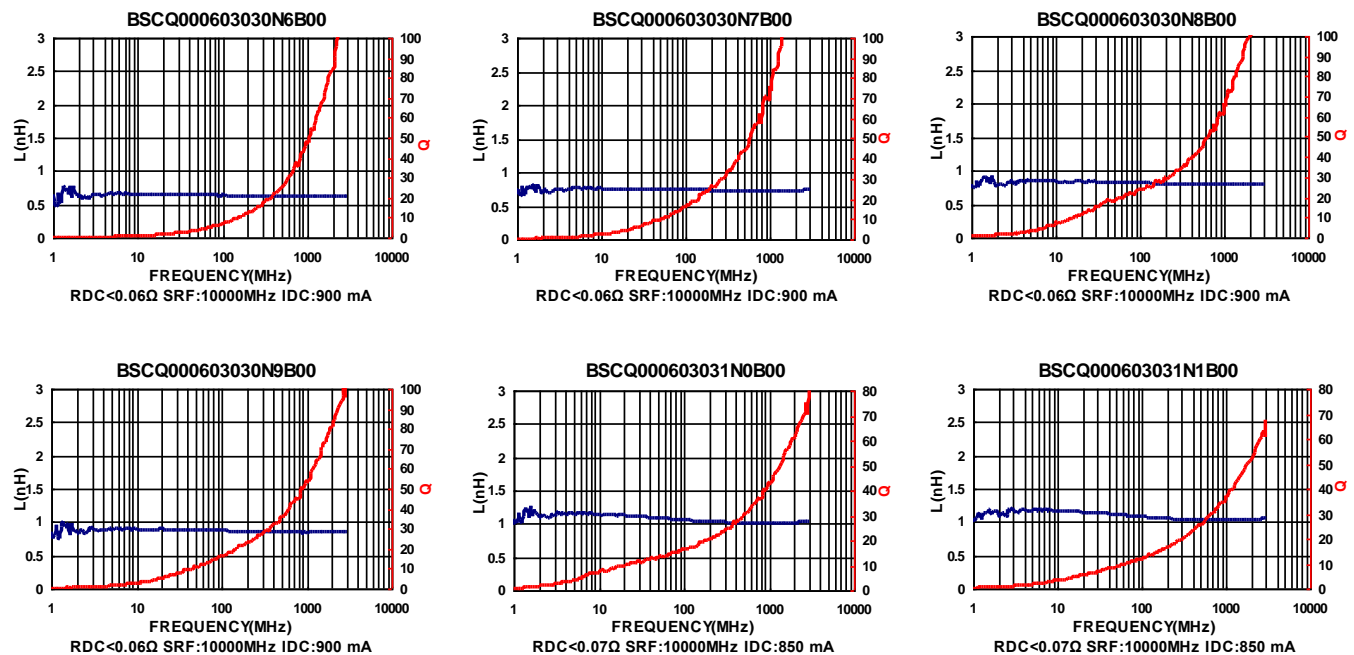

Please be sure to request approval specifications that provide further details of the products. Kindly note that the content of these specifications are subject to change or may be discontinued without prior notice. This product may not be designed/used in medical or high risk applications without Chilisin approval. Please contact our sales department before ordering.

SMD Ceramic Multilayer Chip Inductors – BSCQ Series

Test Instruments : Agilent E4991A Material/Impedance Analyzer

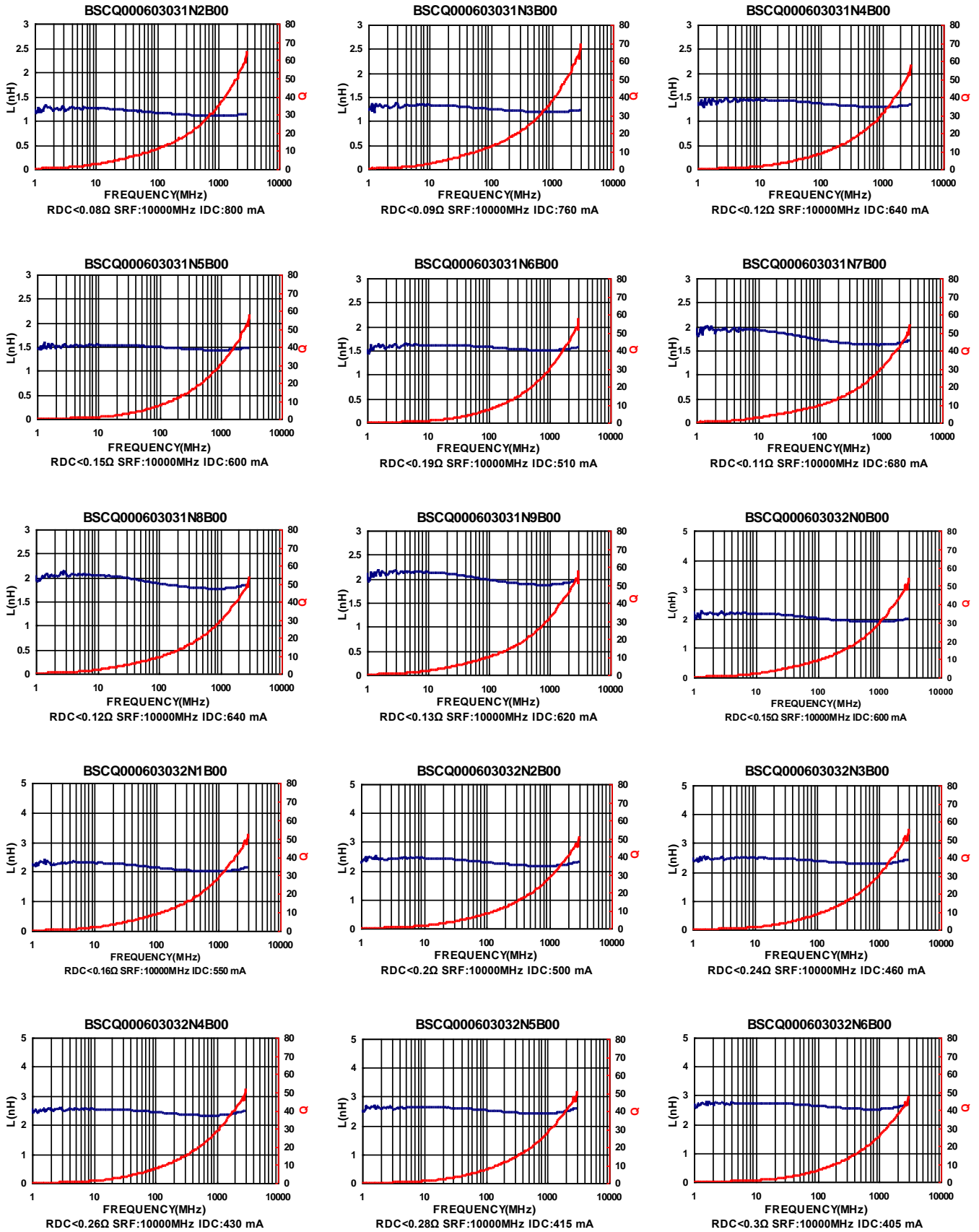

Please be sure to request approval specifications that provide further details of the products. Kindly note that the content of these specifications are subject to change or may be discontinued without prior notice. This product may not be designed/used in medical or high risk applications without Chilisin approval. Please contact our sales department before ordering.

SMD Ceramic Multilayer Chip Inductors – BSCQ Series

Test Instruments : Agilent E4991A Material/Impedance Analyzer

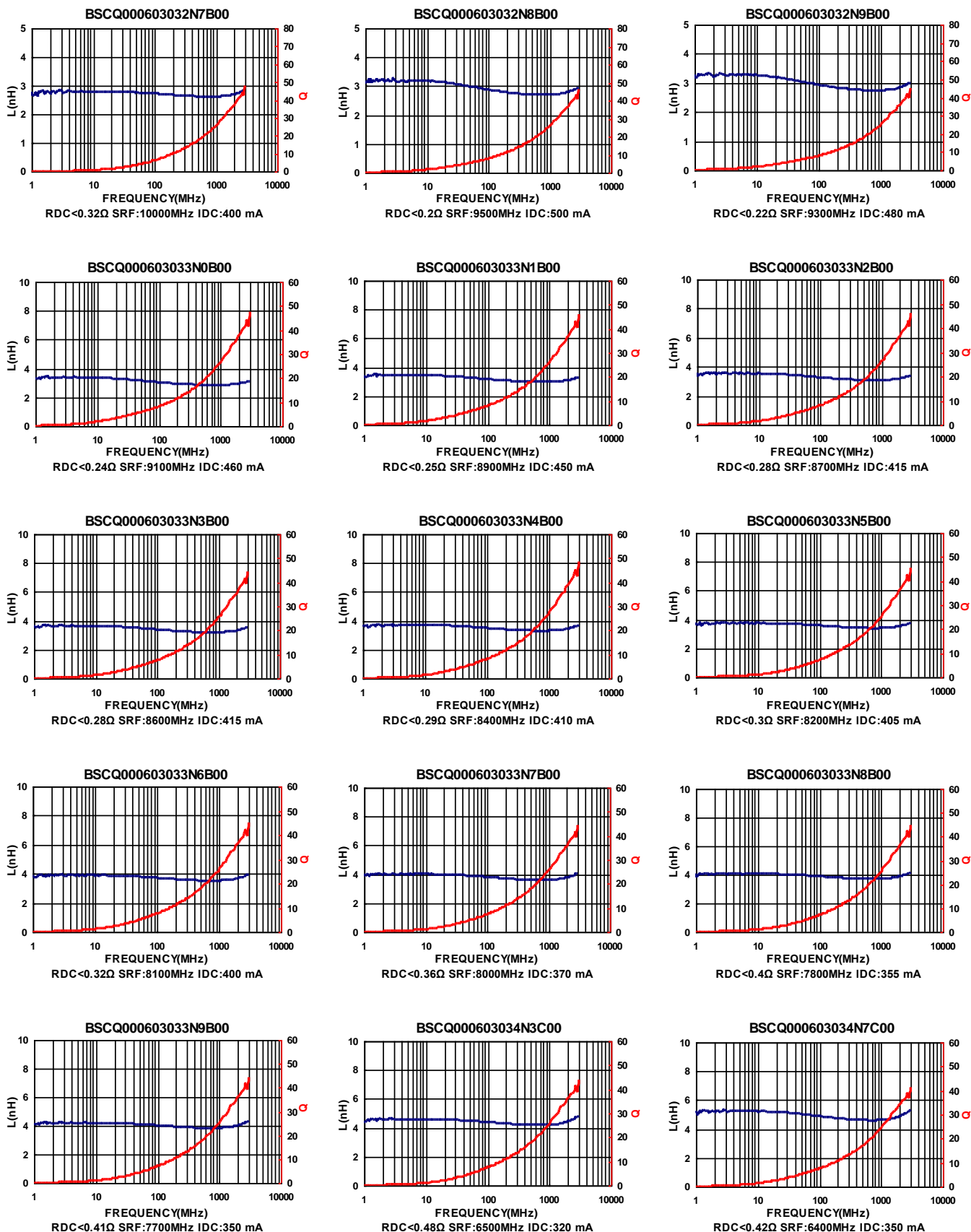

Please be sure to request approval specifications that provide further details of the products. Kindly note that the content of these specifications are subject to change or may be discontinued without prior notice. This product may not be designed/used in medical or high risk applications without Chilisin approval. Please contact our sales department before ordering.

SMD Multilayer Ceramic Chip Inductors – BSCQ Series

Test Instruments : Agilent E4991A Material/Impedance Analyzer

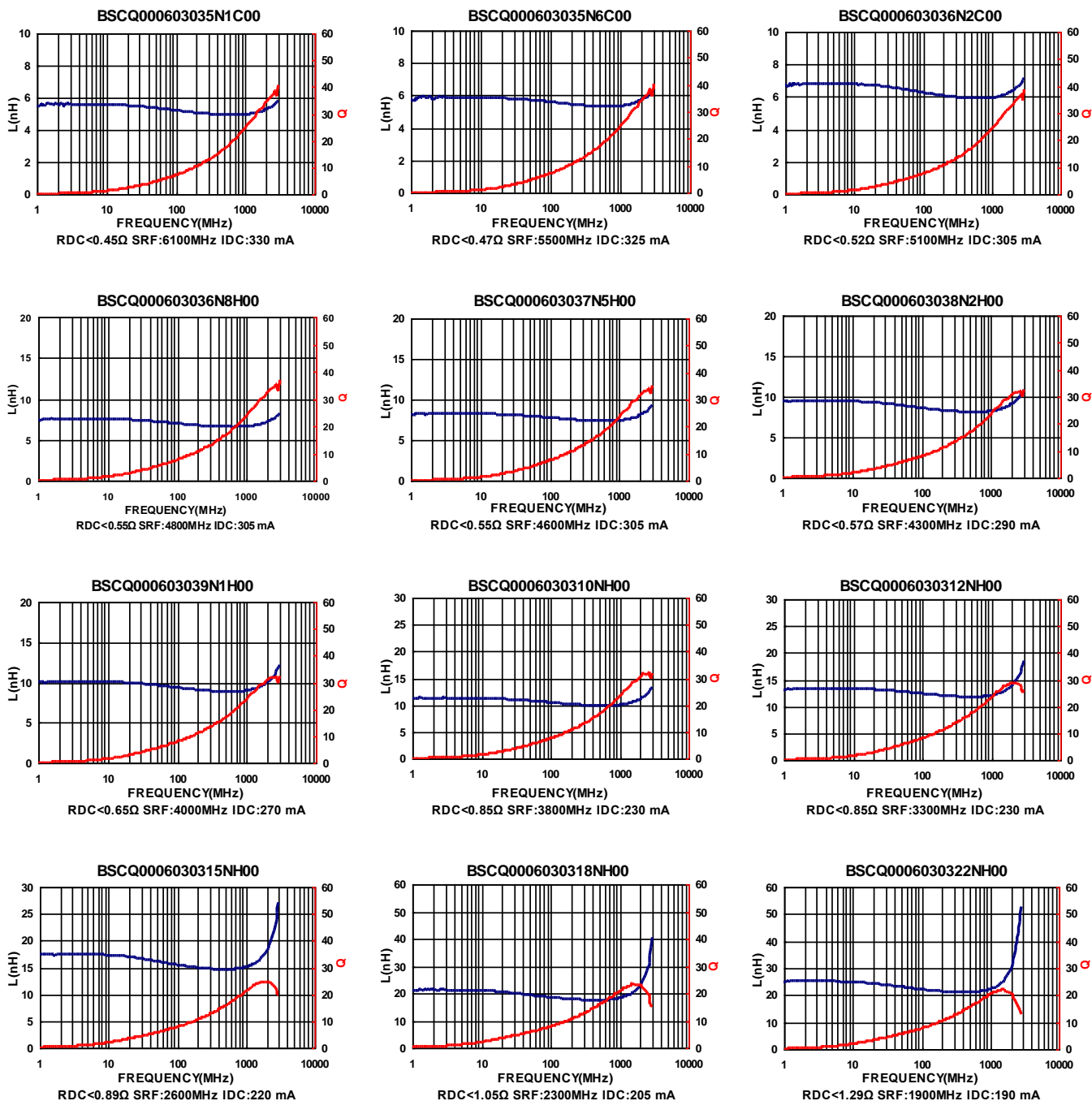

Please be sure to request approval specifications that provide further details of the products. Kindly note that the content of these specifications are subject to change or may be discontinued without prior notice. This product may not be designed/used in medical or high risk applications without Chilisin approval. Please contact our sales department before ordering.

SMD Ceramic Multilayer Chip Inductors – BSCQ Series

Electrical Characteristics

Part Number	Inductance (nH)	Tolerance (±%)	Q Min	Test Frequency (MHz)	SRF (MHz) Min	RDC (Ω) Max	IDC (mA) Max
BSCQ000603030N1□HR	0.1	±0.1nH/±0.2nH/±0.3nH	14	500	10000	0.06	900
BSCQ000603030N2□HR	0.2	±0.1nH/±0.2nH/±0.3nH	14	500	10000	0.06	900
BSCQ000603030N3□HR	0.3	±0.1nH/±0.2nH/±0.3nH	14	500	10000	0.06	900
BSCQ000603030N4□HR	0.4	±0.1nH/±0.2nH/±0.3nH	14	500	10000	0.06	900
BSCQ000603030N5□HR	0.5	±0.1nH/±0.2nH/±0.3nH	14	500	10000	0.07	850
BSCQ000603030N6□HR	0.6	±0.1nH/±0.2nH/±0.3nH	14	500	10000	0.07	850
BSCQ000603030N7□HR	0.7	±0.1nH/±0.2nH/±0.3nH	14	500	10000	0.08	800
BSCQ000603030N8□HR	0.8	±0.1nH/±0.2nH/±0.3nH	14	500	10000	0.09	760
BSCQ000603030N9□HR	0.9	±0.1nH/±0.2nH/±0.3nH	14	500	10000	0.12	640
BSCQ000603031N0□HR	1.0	±0.1nH/±0.2nH/±0.3nH	14	500	10000	0.15	600
BSCQ000603031N1□HR	1.1	±0.1nH/±0.2nH/±0.3nH	14	500	10000	0.19	510
BSCQ000603031N2□HR	1.2	±0.1nH/±0.2nH/±0.3nH	14	500	10000	0.11	680
BSCQ000603031N3□HR	1.3	±0.1nH/±0.2nH/±0.3nH	14	500	10000	0.12	640
BSCQ000603031N4□HR	1.4	±0.1nH/±0.2nH/±0.3nH	14	500	10000	0.13	620
BSCQ000603031N5□HR	1.5	±0.1nH/±0.2nH/±0.3nH	14	500	10000	0.15	600
BSCQ000603031N6□HR	1.6	±0.1nH/±0.2nH/±0.3nH	14	500	10000	0.16	550
BSCQ000603031N7□HR	1.7	±0.1nH/±0.2nH/±0.3nH	14	500	10000	0.20	500
BSCQ000603031N8□HR	1.8	±0.1nH/±0.2nH/±0.3nH	14	500	10000	0.24	460
BSCQ000603031N9□HR	1.9	±0.1nH/±0.2nH/±0.3nH	14	500	10000	0.26	430
BSCQ000603032N0□HR	2.0	±0.1nH/±0.2nH/±0.3nH	14	500	10000	0.28	415
BSCQ000603032N1□HR	2.1	±0.1nH/±0.2nH/±0.3nH	14	500	10000	0.30	405
BSCQ000603032N2□HR	2.2	±0.1nH/±0.2nH/±0.3nH	14	500	10000	0.32	400
BSCQ000603032N3□HR	2.3	±0.1nH/±0.2nH/±0.3nH	14	500	9500	0.20	500
BSCQ000603032N4□HR	2.4	±0.1nH/±0.2nH/±0.3nH	14	500	9300	0.22	480
BSCQ000603032N5□HR	2.5	±0.1nH/±0.2nH/±0.3nH	14	500	9100	0.24	460
BSCQ000603032N6□HR	2.6	±0.1nH/±0.2nH/±0.3nH	14	500	8900	0.25	450
BSCQ000603032N7□HR	2.7	±0.1nH/±0.2nH/±0.3nH	14	500	8700	0.28	415
BSCQ000603032N8□HR	2.8	±0.1nH/±0.2nH/±0.3nH	14	500	8600	0.28	415
BSCQ000603032N9□HR	2.9	±0.1nH/±0.2nH/±0.3nH	14	500	8400	0.29	410
BSCQ000603033N0□HR	3.0	±0.1nH/±0.2nH/±0.3nH	14	500	8200	0.30	405
BSCQ000603033N1□HR	3.1	±0.1nH/±0.2nH/±0.3nH	14	500	8100	0.32	400
BSCQ000603033N2□HR	3.2	±0.1nH/±0.2nH/±0.3nH	14	500	8000	0.36	370

Note: When ordering, please specify tolerance code. Tolerance : B=±0.1nH , C=±0.2nH , S=±0.3nH , H=±3% , J=±5%

- Operating temperature range - 55°C ~ 125°C(Including self - temperature rise)
- IDC : Applied the current to coils, the inductance shall be less than 10% initial value
- Residual impedance of short chip : 0nH
- Measure Equipment :
 L & Q : Agilent E4991A+Agilent 16197A
 SRF : Agilent E4991A or HP19196C
 RDC : HP4338B or CHEN HWA 502

SMD Ceramic Multilayer Chip Inductors – BSCQ Series

Electrical Characteristics

Part Number	Inductance (nH)	Tolerance (±%)	Q Min	Test Frequency (MHz)	SRF (MHz) Min	RDC (Ω) Max	IDC (mA) Max
BSCQ000603033N3□HR	3.3	±0.1nH/±0.2nH/±0.3nH	14	500	7800	0.40	355
BSCQ000603033N4□HR	3.4	±0.1nH/±0.2nH/±0.3nH	14	500	7700	0.41	350
BSCQ000603033N5□HR	3.5	±0.1nH/±0.2nH/±0.3nH	14	500	7700	0.41	350
BSCQ000603033N6□HR	3.6	±0.1nH/±0.2nH/±0.3nH	14	500	6500	0.48	320
BSCQ000603033N7□HR	3.7	±0.1nH/±0.2nH/±0.3nH	14	500	6500	0.48	320
BSCQ000603033N8□HR	3.8	±0.1nH/±0.2nH/±0.3nH	14	500	6500	0.48	320
BSCQ000603033N9□HR	3.9	±0.1nH/±0.2nH/±0.3nH	14	500	6500	0.48	320
BSCQ000603034N3□HR	4.3	±0.2nH/±0.3nH	14	500	6400	0.42	350
BSCQ000603034N7□HR	4.7	±0.2nH/±0.3nH	14	500	6100	0.45	330
BSCQ000603035N1□HR	5.1	±0.2nH/±0.3nH	14	500	5500	0.47	325
BSCQ000603035N6□HR	5.6	±0.2nH/±0.3nH	14	500	5100	0.52	305
BSCQ000603036N2□HR	6.2	±0.2nH/±0.3nH	14	500	4800	0.55	305
BSCQ000603036N8□HR	6.8	3 / 5	14	500	4600	0.55	305
BSCQ000603037N5□HR	7.5	3 / 5	14	500	4300	0.57	290
BSCQ000603038N2□HR	8.2	3 / 5	14	500	4000	0.65	270
BSCQ000603039N1□HR	9.1	3 / 5	14	500	3800	0.85	230
BSCQ0006030310N□HR	10	3 / 5	14	500	3800	0.85	230
BSCQ0006030312N□HR	12	3 / 5	12	500	3300	0.85	230
BSCQ0006030315N□HR	15	3 / 5	12	500	2600	0.89	220
BSCQ0006030318N□HR	18	3 / 5	12	500	2300	1.05	205
BSCQ0006030322N□HR	22	3 / 5	12	500	1900	1.29	190

Note: When ordering, please specify tolerance code. Tolerance : B=±0.1nH , C=±0.2nH , S=±0.3nH , H=±3% , J=±5%

- Operating temperature range - 55°C ~ 125°C(Including self - temperature rise)
- IDC : Applied the current to coils, the inductance shall be less than 10% initial value
- Residual impedance of short chip : 0nH
- Measure Equipment :
 L & Q : Agilent E4991A+Agilent 16197A
 SRF : Agilent E4991A or HP19196C
 RDC : HP4338B or CHEN HWA 502

Test Instruments : Agilent E4991A Material/Impedance Analyzer

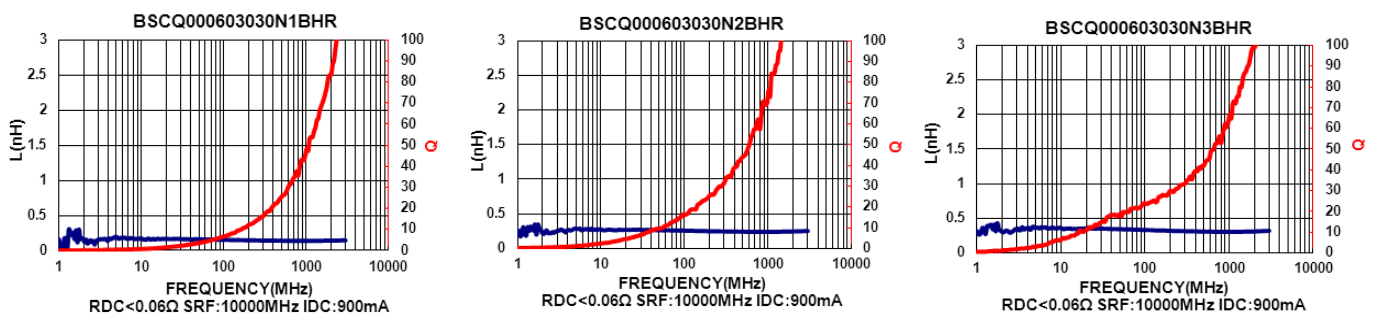

Please be sure to request approval specifications that provide further details of the products. Kindly note that the content of these specifications are subject to change or may be discontinued without prior notice. This product may not be designed/used in medical or high risk applications without Chilisin approval. Please contact our sales department before ordering.

SMD Ceramic Multilayer Chip Inductors – BSCQ Series

Test Instruments : Agilent E4991A Material/Impedance Analyzer

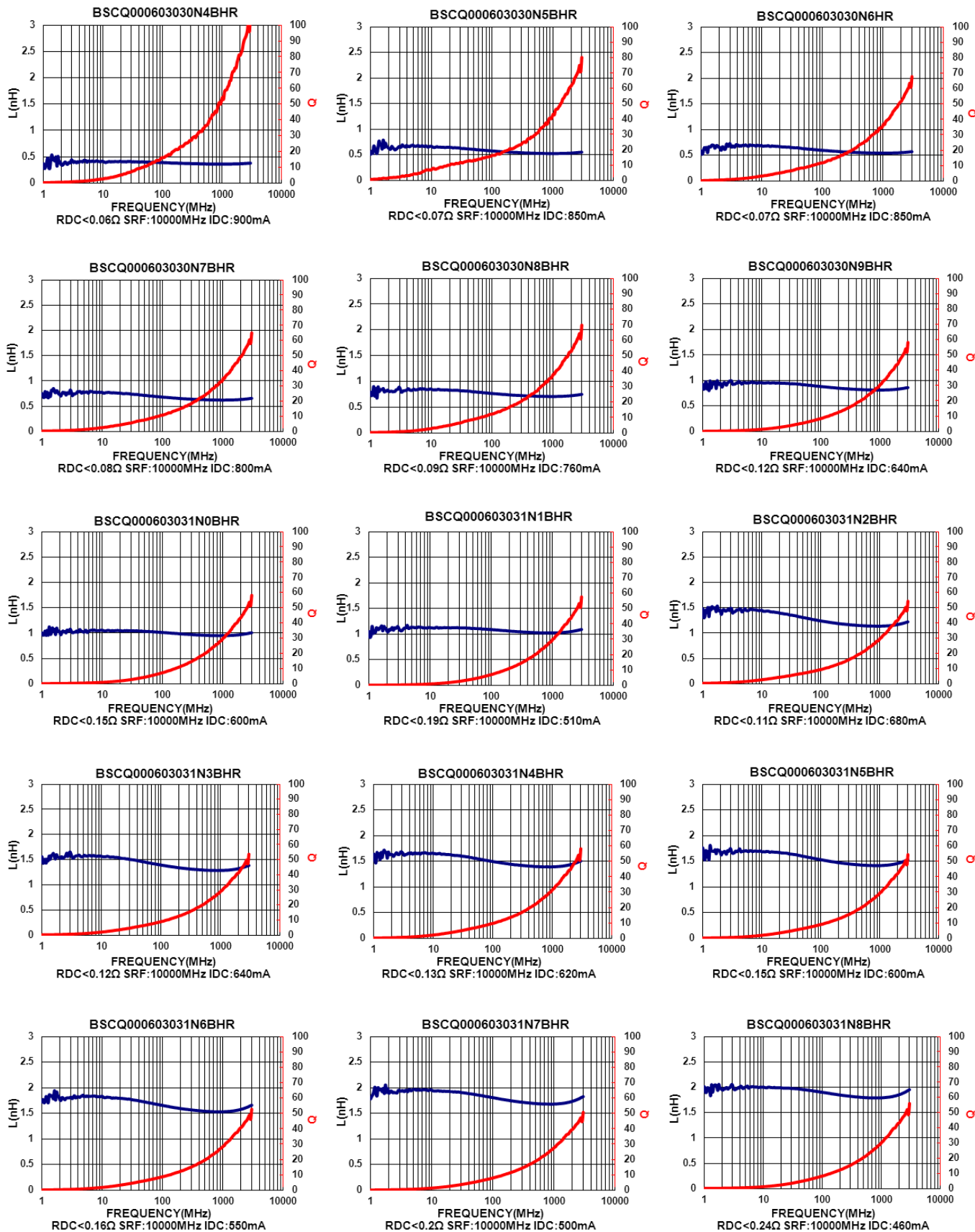

Please be sure to request approval specifications that provide further details of the products. Kindly note that the content of these specifications are subject to change or may be discontinued without prior notice. This product may not be designed/used in medical or high risk applications without Chilisin approval. Please contact our sales department before ordering.

SMD Ceramic Multilayer Chip Inductors – BSCQ Series

Test Instruments : Agilent E4991A Material/Impedance Analyzer

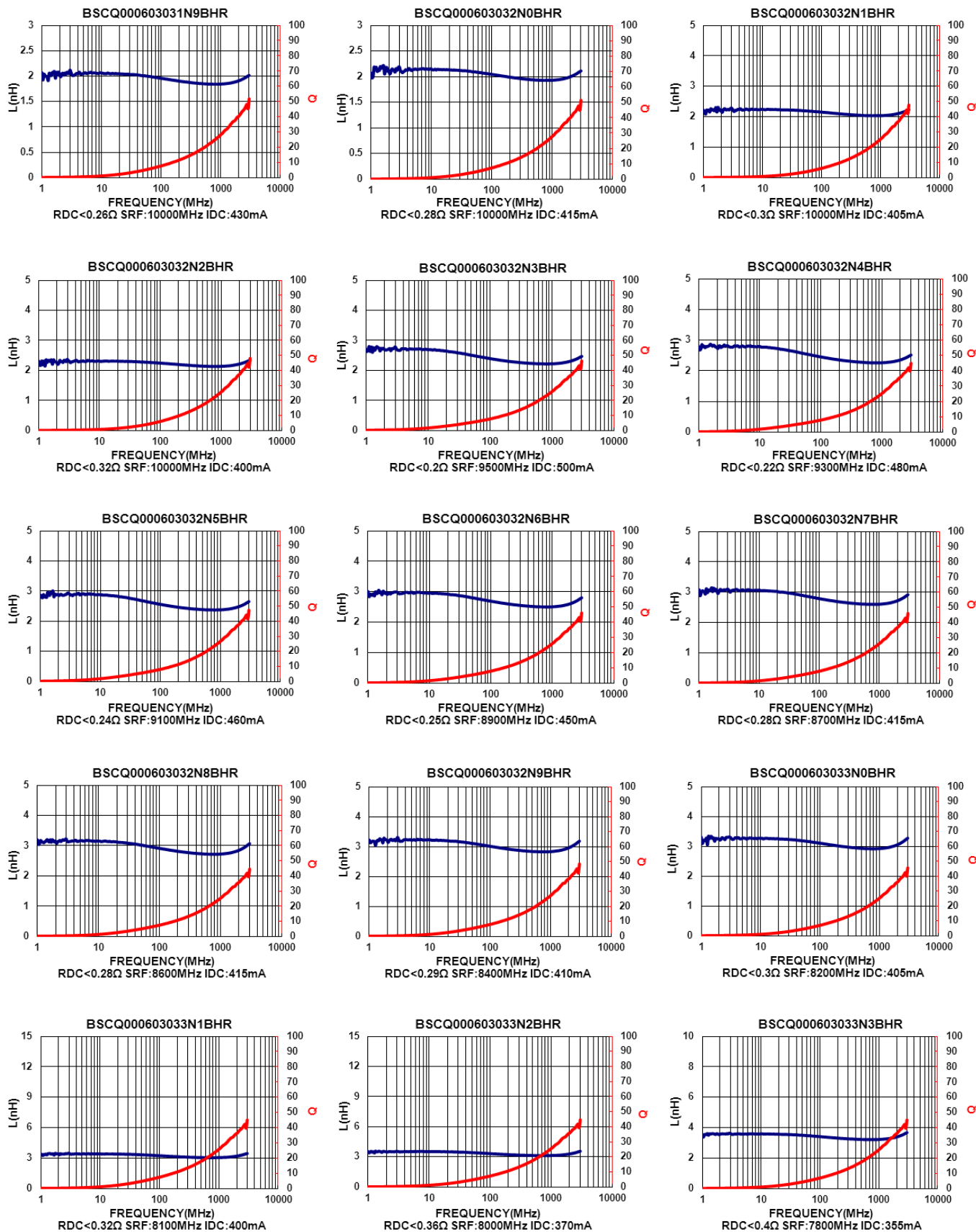

Please be sure to request approval specifications that provide further details of the products. Kindly note that the content of these specifications are subject to change or may be discontinued without prior notice. This product may not be designed/used in medical or high risk applications without Chilisin approval. Please contact our sales department before ordering.

SMD Multilayer Ceramic Chip Inductors – BSCQ Series

Test Instruments : Agilent E4991A Material/Impedance Analyzer

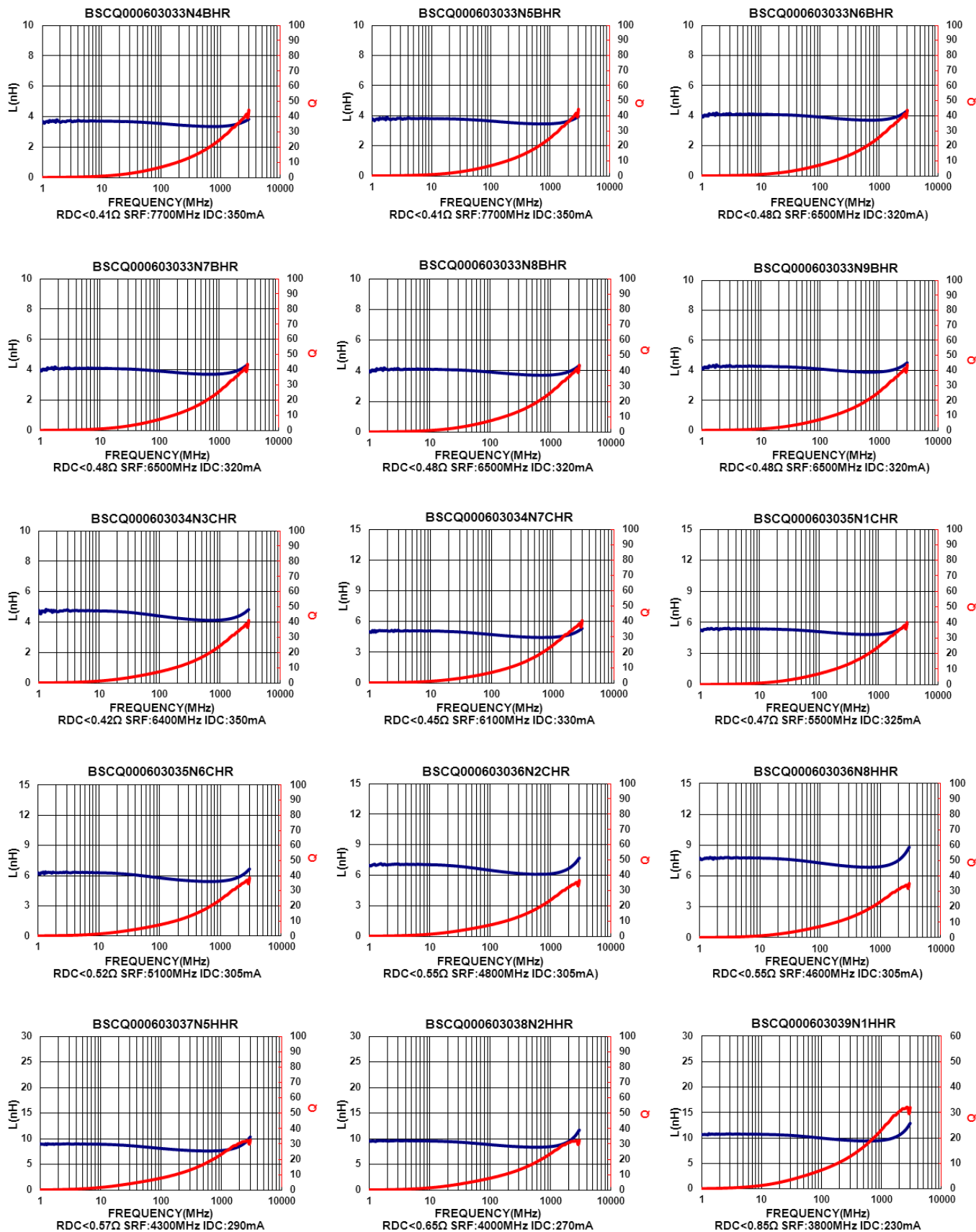

Please be sure to request approval specifications that provide further details of the products. Kindly note that the content of these specifications are subject to change or may be discontinued without prior notice. This product may not be designed/used in medical or high risk applications without Chilisin approval. Please contact our sales department before ordering.

SMD Multilayer Ceramic Chip Inductors – BSCQ Series

Test Instruments : Agilent E4991A Material/Impedance Analyzer

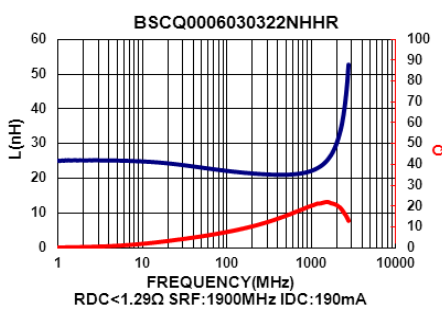
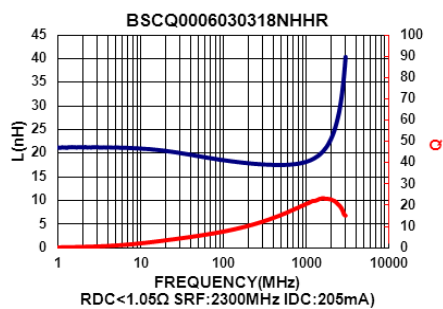
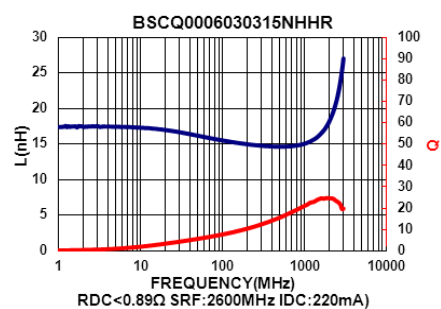
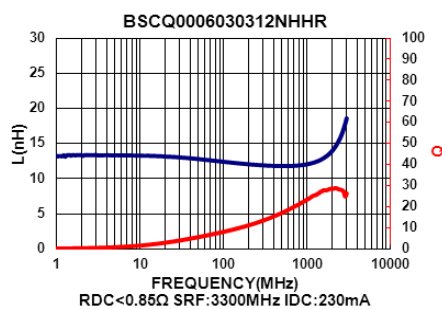
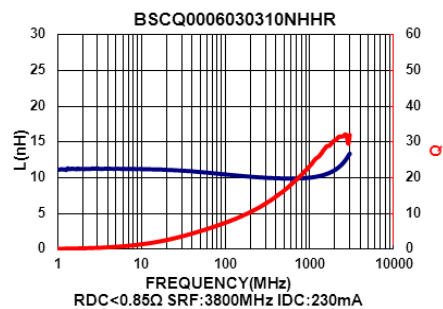

Please be sure to request approval specifications that provide further details of the products. Kindly note that the content of these specifications are subject to change or may be discontinued without prior notice. This product may not be designed/used in medical or high risk applications without Chilisin approval. Please contact our sales department before ordering.

Packaging Specifications

Tape Dimensions

Figure A

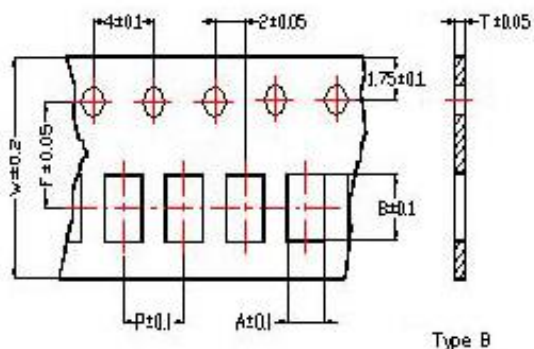

Type B

Tape Material

Figure A

Carrier Tape: Polycarbonate (Tape A)
Carrier Tape: Paper (Tape B)
Cover Tape: Polystyrene

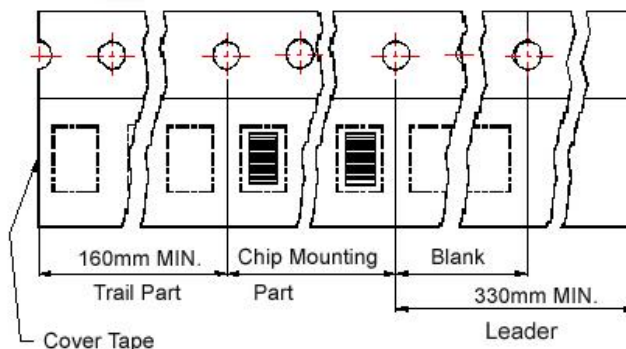
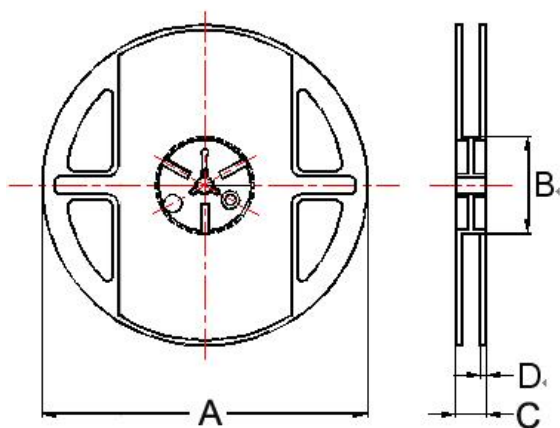
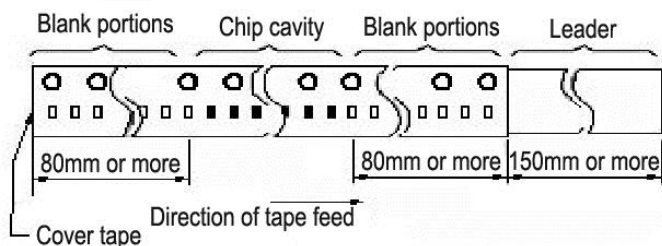

Figure B

Carrier tape : Paper
Cover tape : Polyethylene



Dimensions in mm

TYPE	Tape Dimensions						Tape	Tape	Material	Reel Dimensions				Quantity PCS / Reel
	A	B	T	W	P	F				A	B	C	D	
BSCQ00060303	0.37	0.67	0.42	8	2	3.5	A	B		180	60	13	1.5	15000