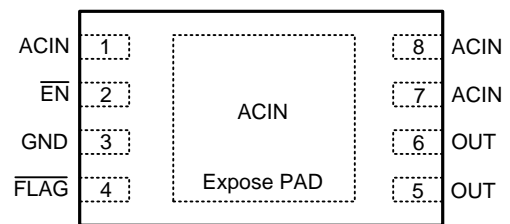

WS3205D
Over voltage and over current protection IC
[Http://www.sh-willsemi.com](http://www.sh-willsemi.com)
Descriptions

The WS3205D is an Over-Voltage-Protection (OVP). The device will switch off internal MOSFET to disconnect ACIN to OUT to protect load when any of input voltage, input current over the threshold. The Over temperature protection (OTP) function monitors chip temperature to protect the device.

The WS3205D is available in DFN2x3-8L package. Standard products are Pb-free and Halogen-free.

DFN2x3-8L

Pin configuration (Top view)
Features

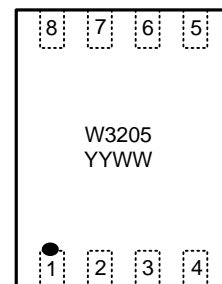
- High voltage technology
- Maximum input voltage : 30V
- Output power ON time : 8ms (Typ.)
- OVP threshold : 6.1V (Typ.)
- OVP response time : <1us
- Output auto discharge
- Small Package : DFN2x3-8L

W3205 = Device code
YY = Year
WW = Week
Marking
Applications

- PND
- Tablet
- OTT
- HD Player
- Digital cameras
- Digital Videos

Order information

Device	Package	Shipping
WS3205D61-8/TR	DFN2x3-8L	3000/Reel&Tape

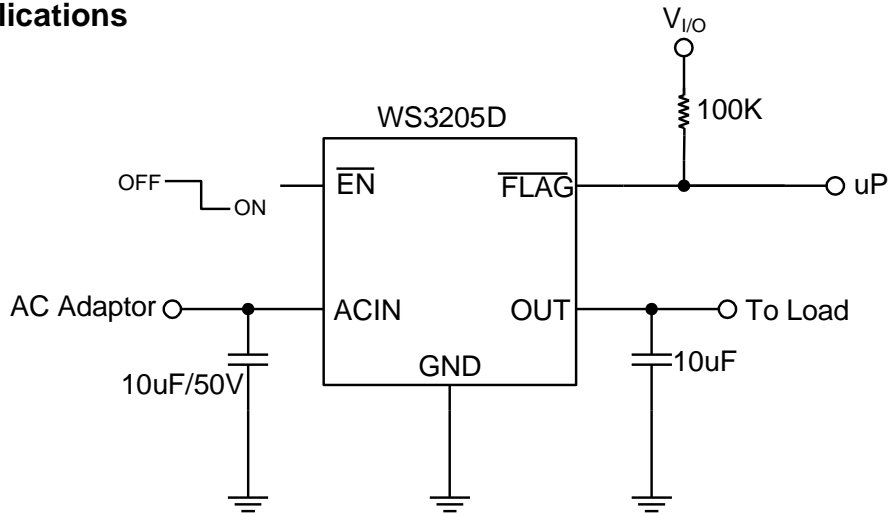
Typical Applications

Pin Descriptions

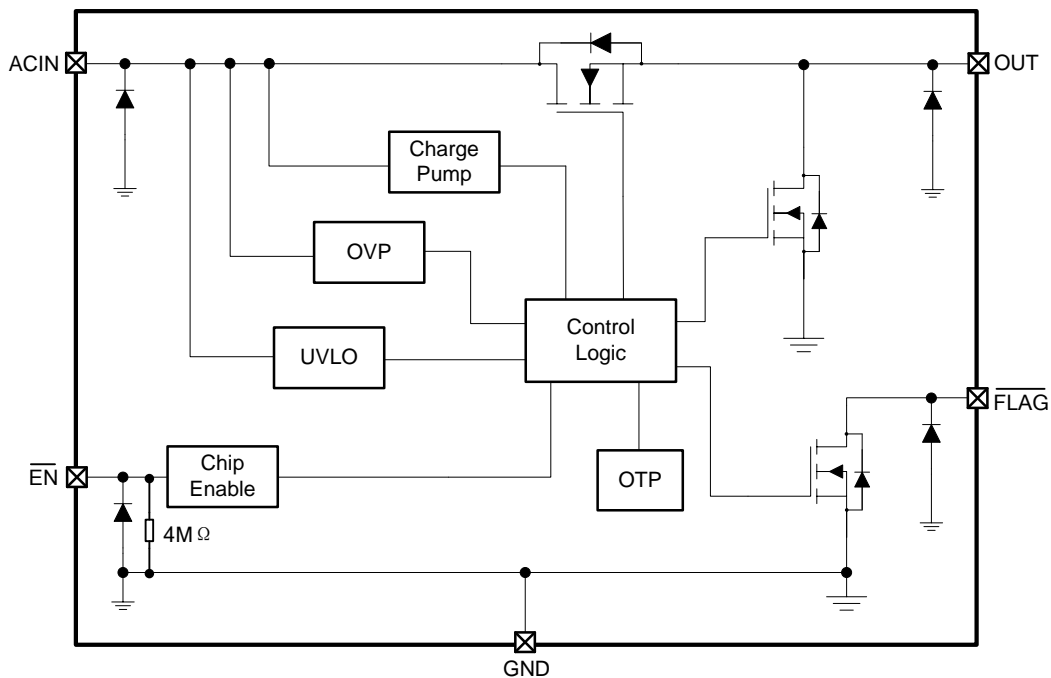
Pin No.	Symbol	Descriptions
3	GND	Ground
1,7,8	ACIN	Input pin, connect to AC adaptor or VBUS. A 10uF low ESR ceramic capacitor or larger must be connected as close as to this pin. It is recommended to use 50V capacitor or according to application.
5,6	OUT	Output pin, Connect to load.
2	$\overline{\text{EN}}$	Enable pin. Active Low.
4	$\overline{\text{FLAG}}$	Flag Pin. Open-Drain, Active low if any OVP, OTP occur.
Expose PAD	ACIN	Input pin. Connect to pin 1, 7, 8.

Block Diagram

Absolute Maximum Ratings

Parameter	Symbol	Value	Unit
Input voltage (IN pin)	V_{IN}	-0.3 ~ 30	V
Output voltage (OUT pin)	V_{OUT}	-0.3 ~ 6.5	V
Power dissipation *1 *3	P_D	0.5	W
Power dissipation *2 *3		0.3	W
Thermal resistance *1	$R_{\theta JA}$	250	°C/W
Thermal resistance *2		416	°C/W
Junction temperature	T_J	150	°C
Lead temperature(10s)	T_L	260	°C
Storage temperature	T_{stg}	-55 ~ 150	°C
ESD Ratings	HBM	±4000	V
	MM	±200	V

Note: These are stress ratings only. Stresses exceeding the range specified under “Absolute Maximum Ratings” may cause substantial damage to the device. Functional operation of this device at other conditions beyond those listed in the specification is not implied and prolonged exposure to extreme conditions may affect device reliability.

*1: Surface mounted on FR-4 Board using 1 square inch pad size, dual side, 1oz copper

*2: Surface mounted on FR-4 board using minimum pad size, 1oz copper

*3: Power dissipation is calculated by $P_D = (V_{IN} - V_{OUT}) \times I_{OUT}$

Recommend Operating Conditions (Ta=25°C, unless otherwise noted)

Parameter	Symbol	Value	Unit
Input voltage	V_{IN}	3.5 ~ 28	V
Output current	I_{OUT}	3	A
Ambient operating temperature	T_{opr}	-40 ~ 85	°C

Electronics Characteristics (Ta=25°C, unless otherwise noted)

Parameter	Symbol	Test conditions	Min.	Typ.	Max.	Unit
DC characteristics and Power-ON-Reset						
Input quiescent current	I_Q	$V_{IN}=5V, I_{OUT}=0A$		280	350	μA
IN-to-OUT ON resistance *1	R_{ON}	$V_{IN}=5V, I_{OUT}=3A$		40		$m\Omega$
Output auto discharge resistance	$R_{DISCHARGE}$			500		Ω
Under voltage lock out threshold	UVLO	V_{IN} increasing from 0~3V		2.35		V
Under voltage lock out hysteresis	$V_{HYS-UVLO}$	V_{IN} decreasing from 3~0V	200	250	300	mV
Output power-on time	T_{ON}	$V_{IN} = 0 \rightarrow 5V$ to output ON	6	8	10	ms
EN Threshold Voltage	V_{ENL}				0.4	V
	V_{ENH}		1.2			V
EN to GND resistance	R_{EN}			4		$M\Omega$
Input Over-Voltage-Protection (OVP)						
OVP threshold	V_{OVP}	V_{IN} increasing from 5~7V	5.8	6.1	6.4	V
OVP hysteresis	$V_{HYS-OVP}$	V_{IN} decreasing from 7~5V		100		mV
OVP active time	T_{OVP}	$V_{IN} = 5 \rightarrow 10V$			1	μs
OVP recovery time	$T_{ON(OVP)}$	$V_{IN} = 10 \rightarrow 5V$ to output ON	6	8	10	ms
Over-Temperature-Protection (OTP)						
OTP threshold				160		$^{\circ}C$
OTP hysteresis				40		$^{\circ}C$
Power Switch Body Diode						
Forward peak surge current*2	I_{FSM}	Pulse Width=10ms			15	A
		Pulse Width=20 μs			50	A

*1: Single Pulse, Pulse width=380 μs

*2: Single Pulse

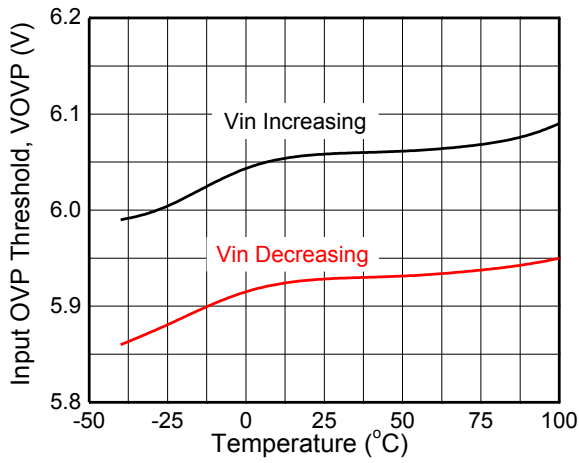
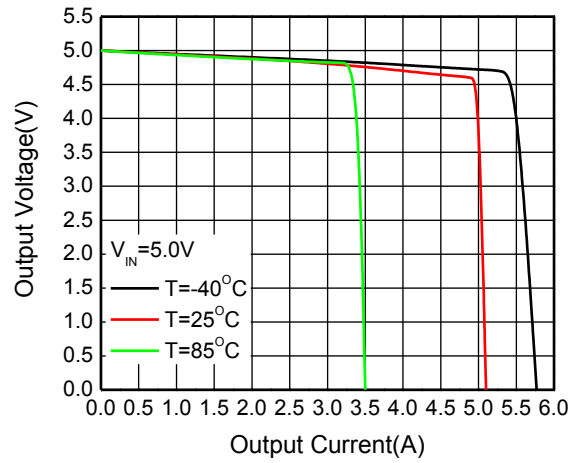
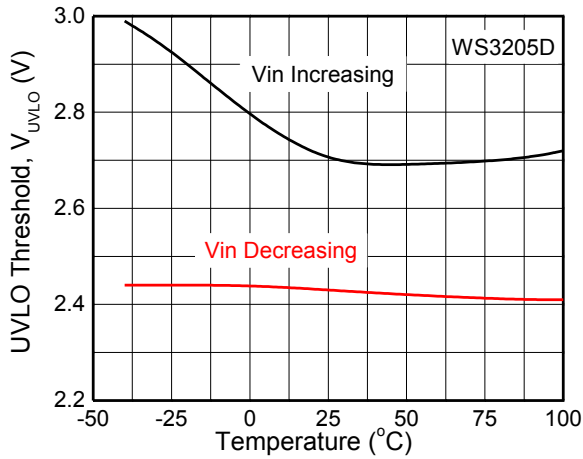
Typical Characteristics (Ta=25°C, unless otherwise noted)

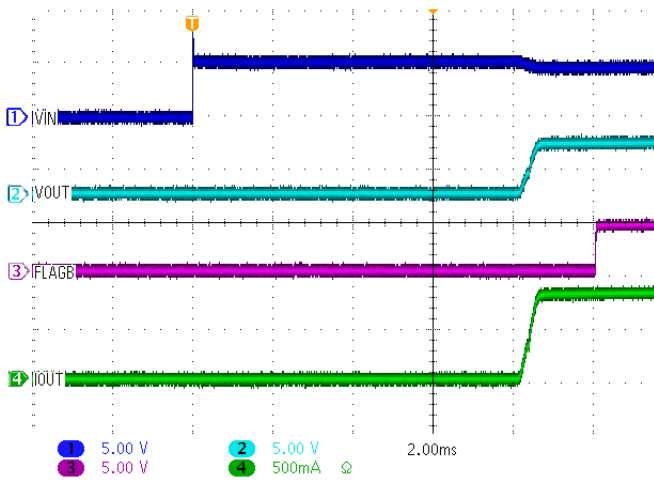
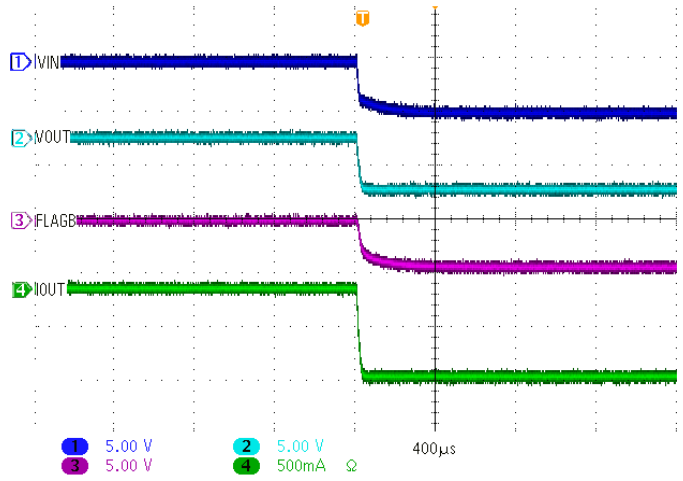
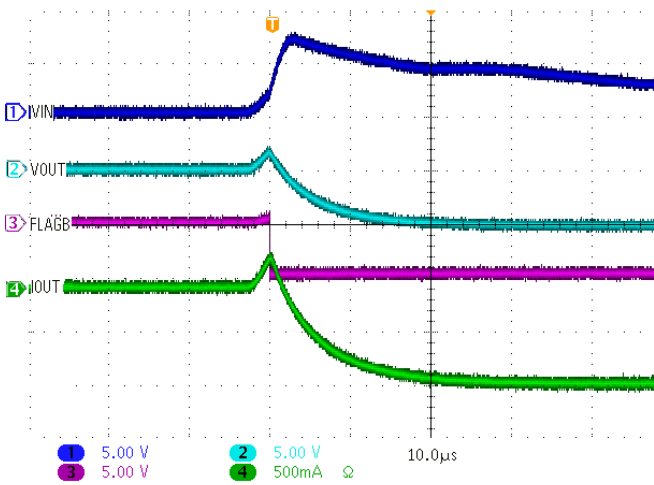
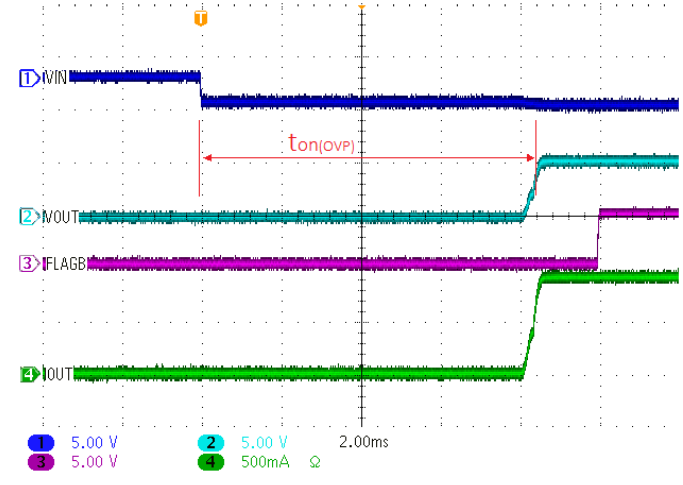
OVP threshold vs. Temperature

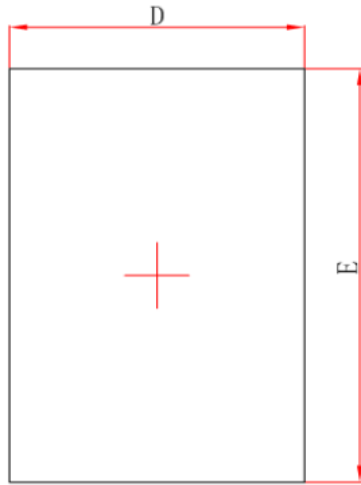
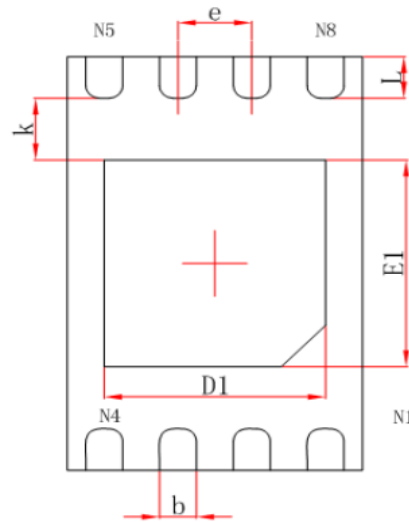
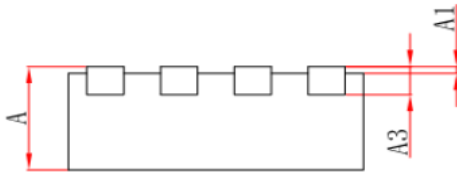
Output voltage vs. Output current

UVLO threshold vs. Temperature

Normally Power ON

Normally Power OFF

OVP Active Time

OVP Recovery Time

Package Outline Dimensions
DFN2*3-8L

Top View

Bottom View

Side View

Symbol	Dimensions In Millimeters		Dimensions In Inches	
	Min.	Max.	Min.	Max.
A	0.500	0.650	0.020	0.026
A1	0.000	0.050	0.000	0.002
A3	0.152REF.		0.006REF.	
D	1.900	2.100	0.075	0.083
E	2.900	3.100	0.114	0.122
D1	1.400	1.600	0.055	0.063
E1	1.300	1.500	0.051	0.059
k	0.200MIN.		0.008MIN.	
b	0.200	0.300	0.008	0.012
e	0.500TYP.		0.020TYP.	
L	0.224	0.376	0.009	0.015