

5.5V, 1A, 2.5MHz Synchronous Step-Down Converter

FEATURES

- High Efficiency: Up to 96%(@3.3V)
- 2.5MHz Constant Frequency Operation
- 1.0A Output Current
- No Schottky Diode Required
- 2.5V to 5.5V Input Voltage Range
- Output Voltage as Low as 0.6V
- 100% Duty Cycle in Dropout
- Low Quiescent Current: 40 μ A
- Slope Compensated Current Mode Control for Excellent Line and Load Transient Response
- Short Circuit Protection
- Thermal Fault Protection
- Inrush Current Limit and Soft Start
- Input over voltage protection (OVP)
- <1 μ A Shutdown Current
- SOT23-5 Package

GENERAL DESCRIPTION

The TMI3101C is a constant frequency, current mode PWM step-down converter. The device integrates a main switch and a synchronous rectifier for high efficiency without an external Schottky diode. It is ideal for powering portable equipment that runs from a single cell Lithium-Ion (Li+) battery. The output voltage can be regulated as low as 0.6V. The TMI3101C can also run at 100% duty cycle for low dropout operation, extending battery life in portable system. This device offers two operation modes, PWM control and PFM Mode switching control, which allows a high efficiency over the wider range of the load.

APPLICATIONS

- Cellular and Smart Phones
- Wireless and DSL Modems
- PDA/MID/PAD
- Digital Still and Video Cameras

TYPICAL APPLICATION

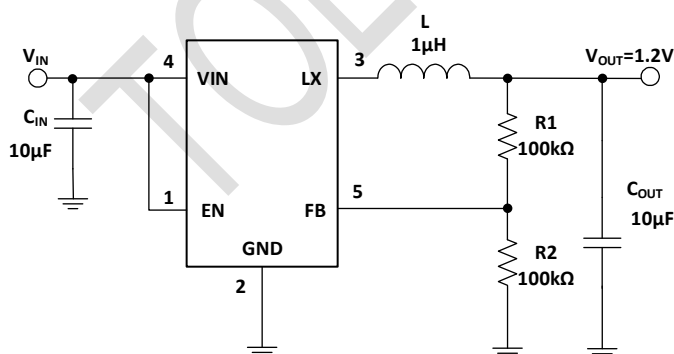
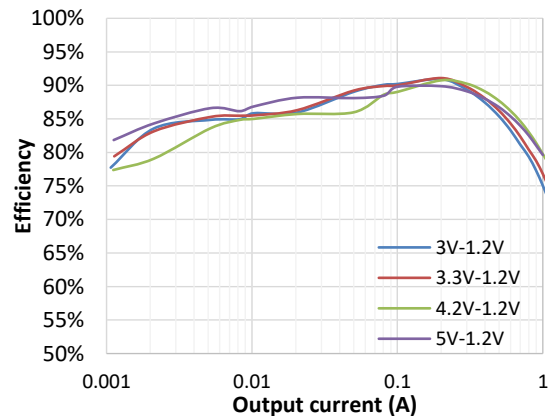

Figure 1. Typical Application Circuit

Efficiency

$V_{OUT}=1.2V$, $I_{OUT}=1mA$ to $1A$, $L_{OUT}=1\mu H$, $T_A=25^\circ C$



ABSOLUTE MAXIMUM RATINGS (Note 1)

Parameter	Value	Unit
Input Supply Voltages	-0.3~6.5	V
LX Voltages	-0.3~6.5	V
EN, FB Voltage	-0.3~6.5	V
Storage Temperature Range	-65~150	°C
Junction Temperature <small>(Note 2)</small>	-40~150	°C
Power Dissipation	600	mW
Lead Temperature Soldering,10Sec	260	°C

PIN CONFIGURATION

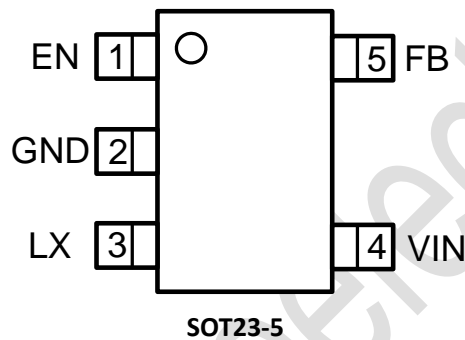

Top Mark: S11BxxC (S11B: Device Code, xxC: Inside Code)

Part Number	Package	Top mark	Quantity/ Reel
TMI3101C	SOT23-5	S11BxxC	3000

TMI3101C devices are Pb-free and RoHS compliant.

PIN FUNCTIONS

Pin	Name	Function
1	EN	Chip Enable Pin. Drive EN above 1.5V to turn on the part. Drive EN below 0.3V to turn it off. Do not leave EN floating.
2	GND	Ground Pin
3	LX	Power Switch Output. It is the switch node connection to Inductor.
4	VIN	Power Supply Input. Must be closely decoupled to GND with a 4.7 μ F or greater ceramic capacitor.
5	FB	Output Voltage Feedback Pin.

ESD RATING

Items	Description	Value	Unit
V _{ESD}	Human Body Model for all pins	\pm 2000	V

JEDEC specification JS-001

RECOMMENDED OPERATING CONDITIONS

Items	Description	Min	Max	Unit
Voltage Range	IN	2.5	5.5	V
T _J	Operating Junction Temperature Range	-40	125	$^{\circ}$ C

THERMAL RESISTANCE (Note 3)

Items	Description	Value	Unit
θ_{JA}	Junction-to-ambient thermal resistance	200	$^{\circ}$ C/W

ELECTRICAL CHARACTERISTICS (Note 4)

($V_{IN}=V_{EN}=3.6V$, $V_{OUT}=1.8V$, $T_A = 25^{\circ}C$, unless otherwise noted.)

Parameter	Test Conditions	Min	Typ	Max	Unit
Input Voltage Range		2.5		5.5	V
OVP Threshold			6.0		V
UVLO Threshold			2.35		V
Quiescent Current	$V_{EN}=2.0V$, $I_{OUT}=0$, $V_{FB}=V_{REF}\times 105\%$		40	100	μA
Shutdown Current	$V_{EN}=0V$		0.1	1.0	μA
Regulated Feedback Voltage	$T_A = 25^{\circ}C$, PWM Operation	0.588	0.600	0.612	V
Output Voltage Load Regulation			0.5		%
Oscillation Frequency	$V_{OUT}=100\%$		2.5		MHz
	$V_{OUT}=0V$		400		kHz
On Resistance of PMOS	$I_{LX}=100mA$		0.29		Ω
On Resistance of NMOS	$I_{LX}=-100mA$		0.18		Ω
Peak Current Limit	$V_{IN}=5V$, $V_{OUT}=1.2V$, $L=4.7\mu H/2A$	1.2			A
EN Input Low Level				0.3	V
EN Input High Level		1.5			V
EN Leakage Current			0.01	1.0	μA
LX Leakage Current	$V_{EN}=0V$, $V_{IN}=V_{LX}=5V$		0.01	1.0	μA
Thermal Shutdown Threshold (Note 4)			150		$^{\circ}C$
Thermal Shutdown Hysteresis (Note 4)			25		$^{\circ}C$

Note 1: Absolute Maximum Ratings are those values beyond which the life of a device may be impaired.

Note 2: T_J is calculated from the ambient temperature T_A and power dissipation P_D according to the following formula: $T_J = T_A + (P_D) \times \theta_{JA}$.

Note 3: Thermal shutdown threshold and hysteresis are guaranteed by design.

FUNCTION DESCRIPTION

The TMI3101C is a high performance 1.0A, 2.5MHz monolithic step-down converter. The TMI3101C requires only three external power components (C_{in} , C_{out} and L). The adjustable version can be programmed with external feedback to any voltage, ranging from 0.6V to the input voltage.

At dropout, the converter duty cycle increases to 100% and the output voltage tracks the input voltage minus the $R_{DS(ON)}$ drop of the high-side MOSFET.

The internal error amplifier and compensation provides excellent transient response, load, and line regulation. Soft start function prevents input inrush current and output overshoot during start up.

FUNCTIONAL BLOCK DIAGRAM

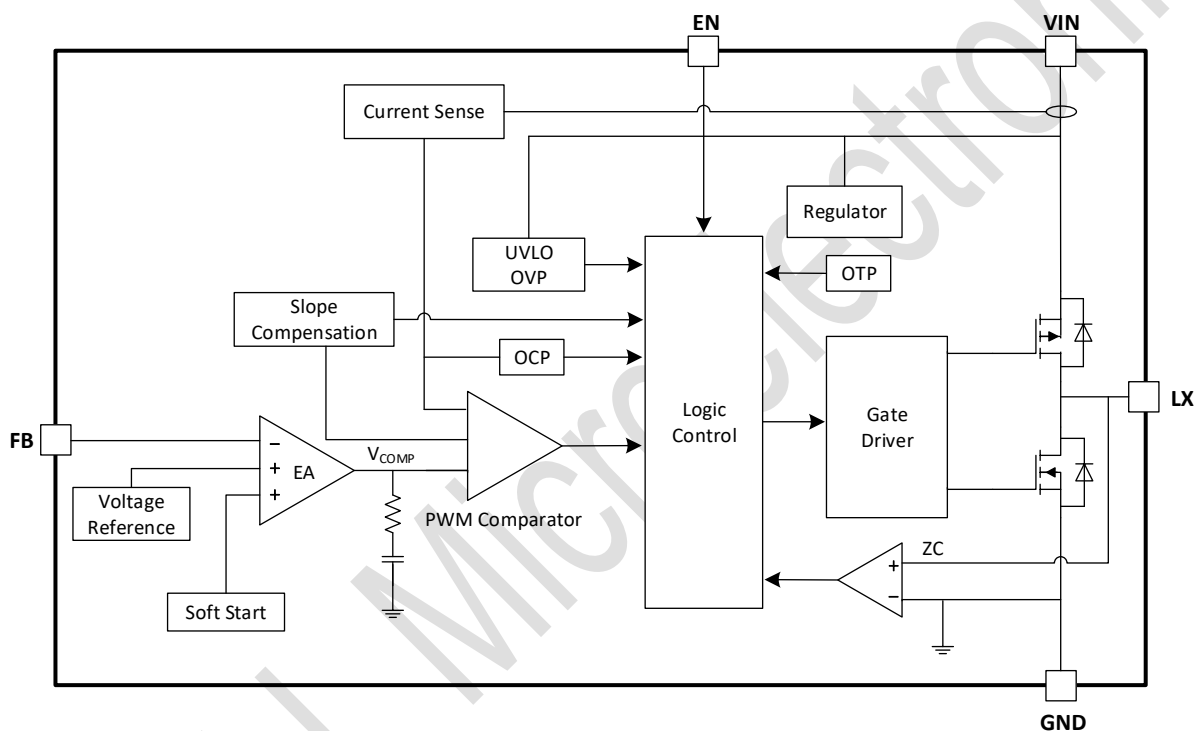

Figure 2. TMI3101C Block Diagram

APPLICATION INFORMATION

Setting the Output Voltage

Figure 1 shows the basic application circuit for the TMI3101C. The TMI3101C can be externally programmed. Resistors R1 and R2 in Figure 1 program the output to regulate at a voltage higher than 0.6V. The external resistor sets the output voltage according to the following equation:

$$V_{OUT} = 0.6 \times \left(1 + \frac{R_1}{R_2}\right)$$

$$R_1 = (V_{OUT} / 0.6 - 1) \times R_2$$

Inductor Selection

For most designs, 1μH inductance can satisfy most application conditions. Inductance value is related to inductor ripple current value, input voltage, output voltage setting and switching frequency. The inductor value can be derived from the following equation:

$$L = \frac{V_{OUT} \times (V_{IN} - V_{OUT})}{V_{IN} \times \Delta I_L \times f_{OSC}}$$

Where ΔI_L is inductor ripple current. Large value inductors result in lower ripple current and small value inductors result in high ripple current, so inductor value has effect on output voltage ripple value.

Input Capacitor Selection

The input capacitor reduces the surge current drawn from the input and switching noise from the device. The input capacitor impedance at the switching frequency should be less than input source impedance to prevent high frequency switching current passing to the input.

A low ESR input capacitor sized for maximum RMS current must be used. Ceramic capacitors with X5R or X7R dielectrics are highly recommended because of their low ESR and small temperature coefficients.

A 4.7μF ceramic capacitor for most applications is sufficient. A large value may be used for improved input voltage filtering.

Output Capacitor Selection

The output capacitor is required to keep the output voltage ripple small and to ensure regulation loop stability. The output capacitor must have low impedance at the switching frequency. Ceramic capacitors with X5R or X7R dielectrics are recommended due to their low ESR and high ripple current ratings. The output ripple V_{OUT} is determined by:

$$\Delta V_{OUT} \leq \frac{V_{OUT} \times (V_{IN} - V_{OUT})}{V_{IN} \times f_{OSC} \times L} \times \left(ESR + \frac{1}{8 \times f_{osc} \times C3} \right)$$

A 10μF ceramic can satisfy most applications.

Layout Consideration

When laying out the printed circuit board, the Following checking should be used to ensure proper operation of the TMI3101C. Check the following in your layout:

1. The power traces, consisting of the GND trace, the LX trace and the VIN trace should be kept short, direct and wide.
2. Does the (+) plates of Cin connect to Vin as closely as possible. This capacitor provides the AC current to the internal power MOSFETs.
3. Keep the switching node, LX, away from the sensitive VOUT node.
4. Keep the (-) plates of Cin and Cout as close as possible

TOLL Microelectronic

TYPICAL PERFORMANCE CHARACTERISTICS

Test condition: $V_{IN}=5V$, $V_{OUT}=1.2V$, $L=1\mu H$, $T_A=+25^\circ C$, unless other noted.

Efficiency at $V_{OUT} = 1.2V$

$V_{OUT}=1.2V$, $L=1\mu H$, $T_A=25^\circ C$

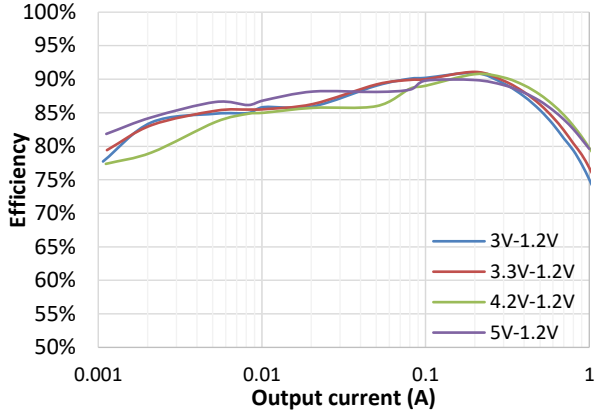

Efficiency at $V_{OUT}=3.3V$

$V_{OUT}=3.3V$, $L=1\mu H$,

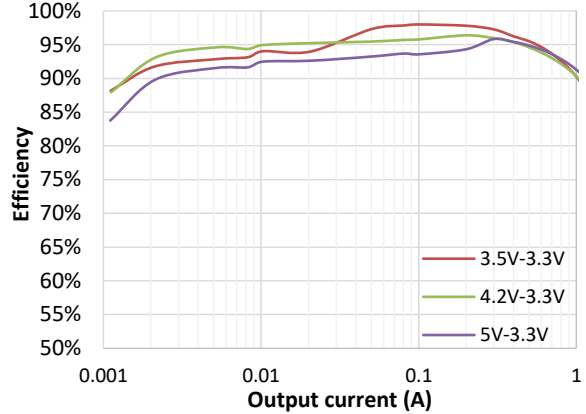

Load Regulation

$V_{OUT} = 1.2V$, $L=1\mu H$

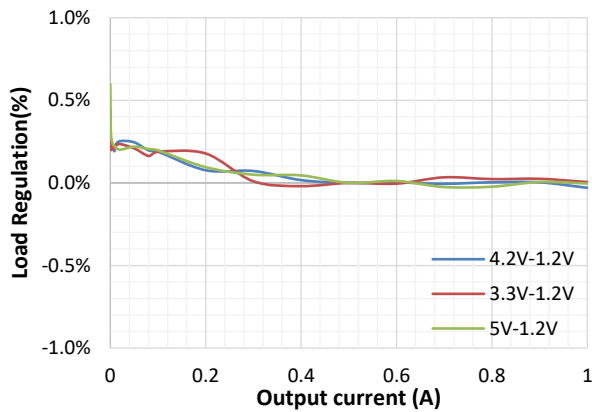

Line Regulation

$V_{OUT} = 1.2V$, $L=1\mu H$

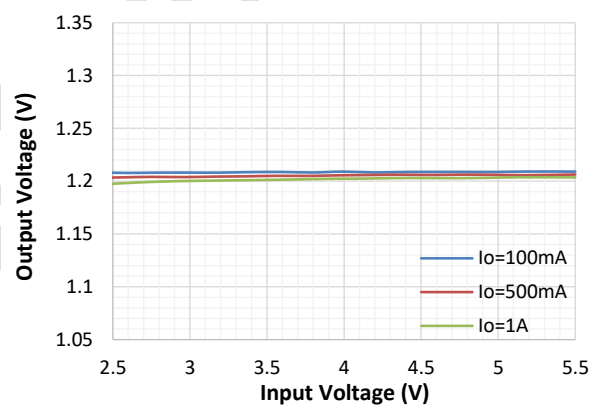

Steady State Operation

$V_{IN}=5V$, $V_{OUT}=1.2V$, No Load

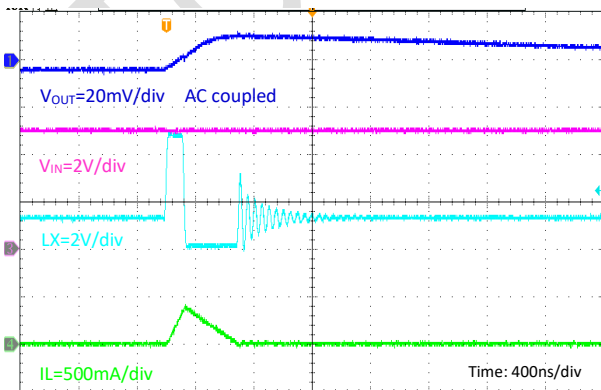

Steady State Operation

$V_{IN}=5V$, $V_{OUT}=1.2V$, $I_o=1A$

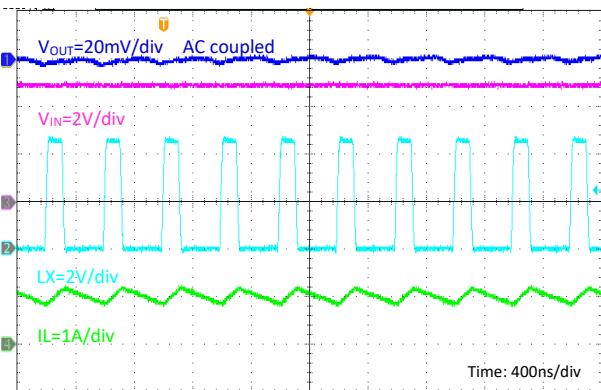

TYPICAL PERFORMANCE CHARACTERISTICS (continued)

Load Transient

$V_{IN} = 5V, V_{OUT} = 1.2V, I_o = 0A \text{ to } 1A$

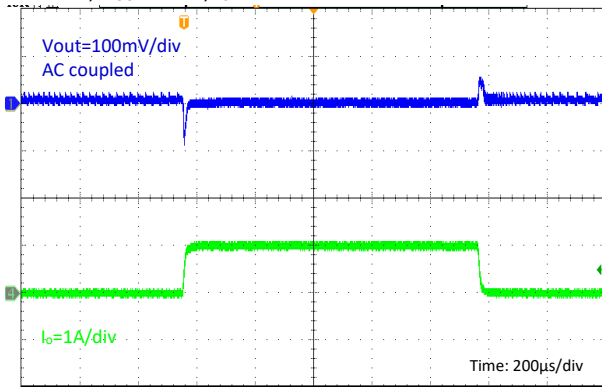

Load Transient

$V_{IN} = 5V, V_{OUT} = 1.2V, I_o = 0.5A \text{ to } 1A$

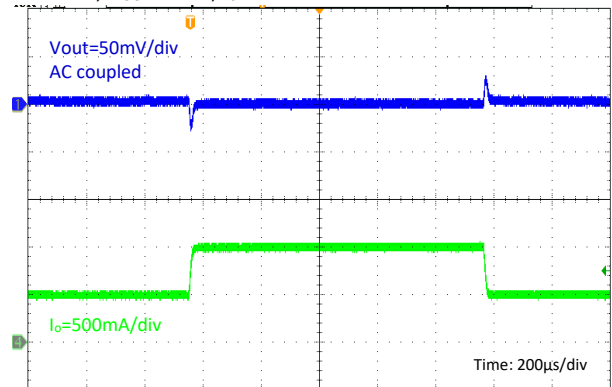

Input Power On

$V_{IN} = 5V, V_{OUT} = 1.2V, I_o = 1A$

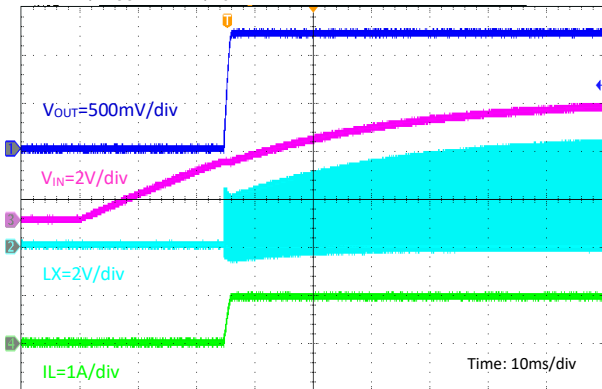

Input Power Off

$V_{IN} = 5V, V_{OUT} = 1.2V, I_o = 1A$

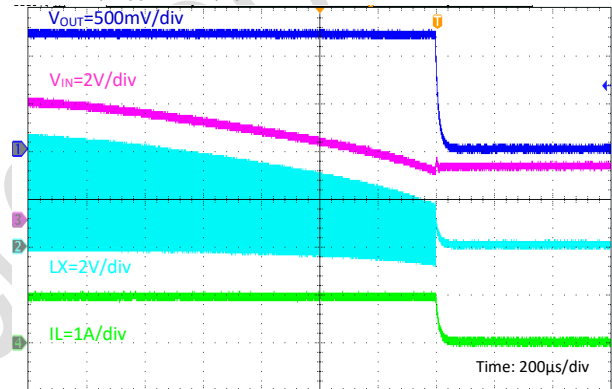

EN Enable Power On

$V_{IN} = 5V, V_{EN} = 3.6V, V_{OUT} = 1.2V, \text{No Load}$

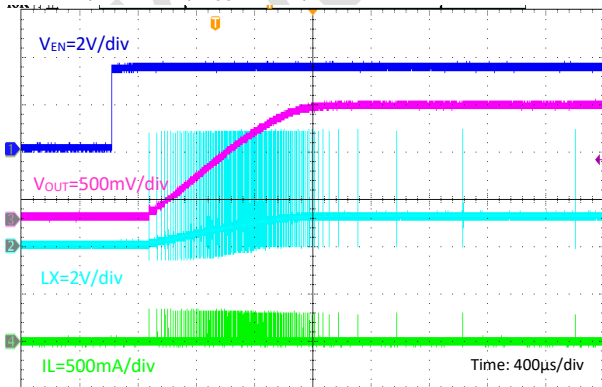

EN Disable Power Off

$V_{IN} = 5V, V_{EN} = 3.6V, V_{OUT} = 1.2V, \text{No Load}$

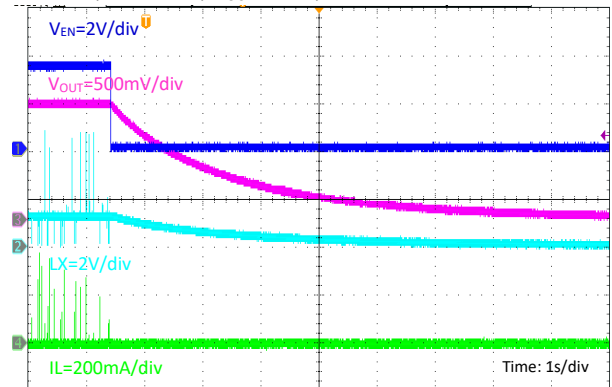

TYPICAL PERFORMANCE CHARACTERISTICS (continued)

EN Enable Power On

$V_{IN} = 5V, V_{EN} = 3.6V, V_{OUT} = 1.2V, I_o = 1A$

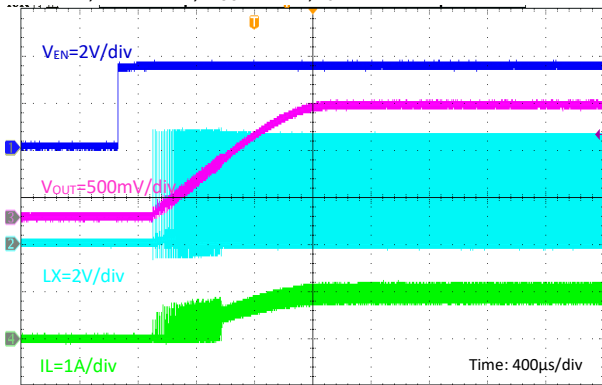

EN Enable Power Off

$V_{IN} = 5V, V_{EN} = 3.6V, V_{OUT} = 1.2V, I_o = 1A$

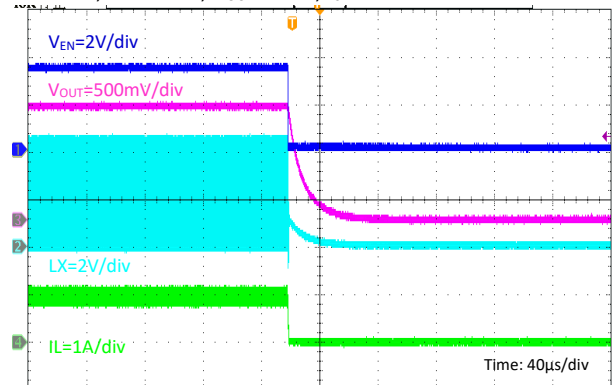

Output Short Entry

$V_{IN} = 5V, V_{OUT} = 1.2V, \text{No Load}$

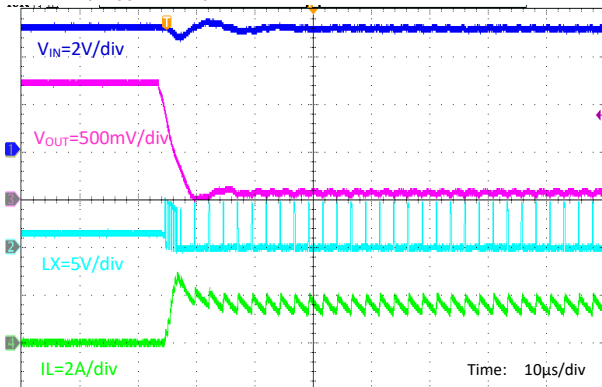

Output Short Recovery

$V_{IN} = 5V, V_{OUT} = 1.2V, \text{No Load}$

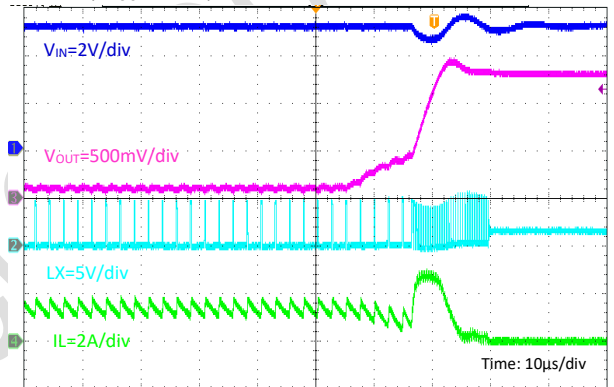

PACKAGE INFORMATION

SOT23-5

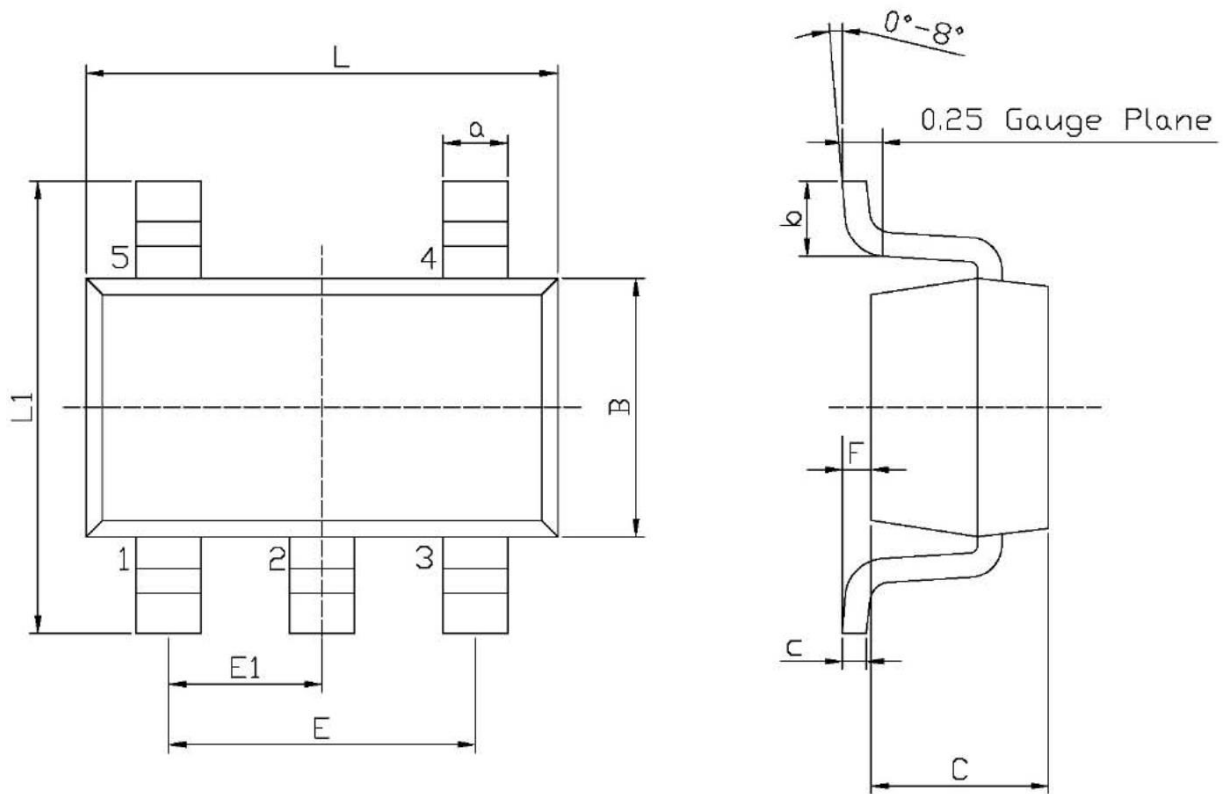

Unit: mm

Symbol	Dimensions In Millimeters		Symbol	Dimensions In Millimeters	
	Min	Max		Min	Max
L	2.82	3.02	E1	0.85	1.05
B	1.50	1.70	a	0.35	0.50
C	0.90	1.30	c	0.10	0.20
L1	2.60	3.00	b	0.35	0.55
E	1.80	2.00	F	0	0.15

Note:

- 1) All dimensions are in millimeters.
- 2) Package length does not include mold flash, protrusion or gate burr.
- 3) Package width does not include inter lead flash or protrusion.
- 4) Lead popularity (bottom of leads after forming) shall be 0.10 millimeters max.
- 5) Pin 1 is lower left pin when reading top mark from left to right.

TAPE AND REEL INFORMATION

TAPE DIMENSIONS:

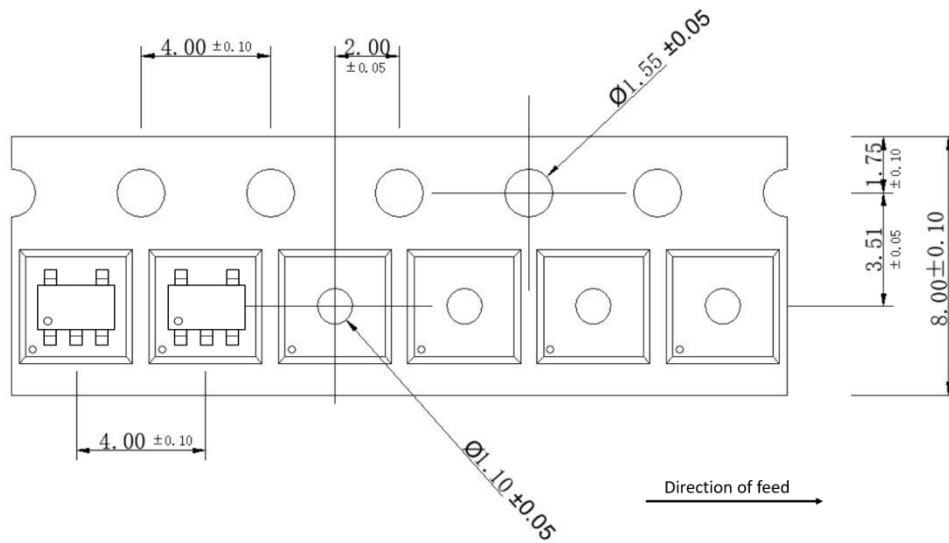

REEL DIMENSIONS:

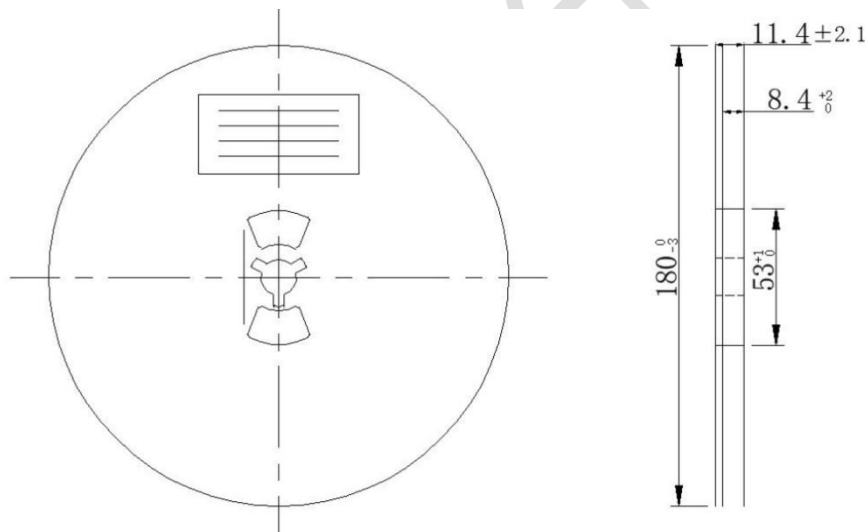

Note:

- 1) All Dimensions are in Millimeter
- 2) Quantity of Units per Reel is 3000
- 3) MSL level is level 3.