

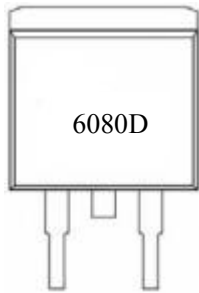
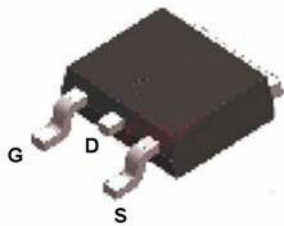
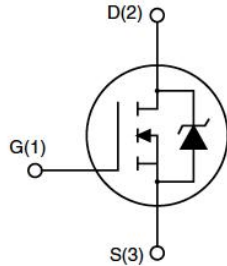

<p><b>Features</b></p> <ul style="list-style-type: none"> <li>Extremely Low RDS(on): Typ.RDS(on) = 7.0mΩ @VGS=10 V,Id=40 A</li> <li>Low gate charge ( typical 75 nC)</li> <li>Fast switching</li> <li>100% avalanche tested</li> </ul>	<p><b>General Description</b></p> <p>The 6080D uses advanced trench Technology and design to provide excellent RDS(ON) with low gate charge. It can be use in a wide variety of applications.</p>
<p><b>Package</b></p> <div style="display: flex; justify-content: space-around; align-items: flex-end;"> <div style="text-align: center;">  <p>Marking and pin assignment</p> </div> <div style="text-align: center;">  <p>TO-263top view</p> </div> <div style="text-align: center;">  <p>Schematic diagram</p> </div> </div>	

### Absolute Maximum Ratings (T<sub>C</sub>=25°C unless otherwise specified)

Symbol	Parameter	Value	Units
V <sub>DS</sub>	Drain-Source Voltage	60	V
I <sub>D</sub>	Drain Current - Continuous (T <sub>C</sub> = 25°C) - Continuous (T <sub>C</sub> = 70° C)	80	A
		64*	A
I <sub>DM</sub>	Drain Current - Pulsed (Note 1)	280*	A
V <sub>GS</sub>	Gate-Source Voltage	± 20	V
E <sub>AS</sub>	Single Pulsed Avalanche Energy (Note 2)	405	mJ
E <sub>AR</sub>	Repetive Avalanche Energy (Note 1)	46	mJ
dv/dt	Peak diode recovery dv/dt (note 3)	5	V/ns
P <sub>D</sub>	Power Dissipation (T <sub>C</sub> = 25°C) - Derate above 25°C	128	W
		1.2	W/°C
T <sub>J</sub> , T <sub>stg</sub>	Operating and Storage Temperature Range	-55 to +150	°C
T	Maximum lead temperature for soldering,purpose, 1/8 from case for 5 seconds	300	°C

\* Drain current limited by maximum junction temperature

### Thermal Characteristics

Symbol	Parameter	Value	Units
R <sub>θJC</sub>	Thermal Resistance, Junction-to-Case	0.56	°C/W
R <sub>θJA</sub>	Thermal Resistance, Junction-to-Ambient	58.7	°C/W



#### Electrical Characteristics (T<sub>C</sub>=25°C unless otherwise specified)

Symbol	Parameter	Test Conditions	Min	Typ	Max	Units
<b>Off Characteristics</b>						
BV <sub>DSS</sub>	Drain-Source Breakdown Voltage	V <sub>GS</sub> = 0 V, I <sub>D</sub> = 250 μA	68			V
ΔBV <sub>DSS</sub> /ΔT <sub>J</sub>	Breakdown Voltage Temperature Coefficient	I <sub>D</sub> = 250 μA, Referenced to 25°C		58		mV/°C
I <sub>DSS</sub>	Zero Gate Voltage Drain Current	V <sub>DS</sub> = 68 V, V <sub>GS</sub> = 0 V			1	μA
		V <sub>DS</sub> = 54 V, T <sub>C</sub> = 125°C			10	μA
I <sub>GSSF</sub>	Gate Leakage Current, Forward	V <sub>GS</sub> = 20 V, V <sub>DS</sub> = 0 V			100	nA
I <sub>GSSR</sub>	Gate Leakage Current, Reverse	V <sub>GS</sub> = -20 V, V <sub>DS</sub> = 0 V			-100	nA
<b>On Characteristics</b>						
V <sub>GS(TH)</sub>	Gate Threshold voltage	V <sub>DS</sub> = V <sub>GS</sub> , I <sub>D</sub> = 250 μA	2	3	4	V
R <sub>DS(on)</sub>	Drain-Source on-state resistance	V <sub>GS</sub> = 10 V, I <sub>D</sub> = 40 A		7.0	9.2	mΩ
g <sub>FS</sub>	Forward Transconductance	V <sub>DS</sub> = 10 V, I <sub>D</sub> = 40 A (Note 3)		34.0		S
<b>Dynamic Characteristics</b>						
C <sub>iss</sub>	Input capacitance	V <sub>DS</sub> = 25 V, V <sub>GS</sub> = 0 V, f = 1.0 MHz		3899		pF
C <sub>oss</sub>	Output capacitance			321		pF
C <sub>rss</sub>	Reverse transfer capacitance			303		pF
<b>Switching Characteristics</b>						
t <sub>d(on)</sub>	Turn On Delay Time			20		ns
t <sub>r</sub>	Rising Time			52		ns
t <sub>d(off)</sub>	Turn Off Delay Time	V <sub>DD</sub> = 35 V, I <sub>D</sub> = 40 A, V <sub>GS</sub> = 10 V, R <sub>G</sub> = 4.7 Ω (Note 3, 4)		49		ns
t <sub>f</sub>	Fall Time			23		ns
Q <sub>g</sub>	Total Gate Charge	V <sub>DS</sub> = 35 V, I <sub>D</sub> = 40 A, V <sub>GS</sub> = 10 V (Note 3, 4)		75		nC
Q <sub>gs</sub>	Gate-Source Charge			26		nC
Q <sub>gd</sub>	Gate-Drain Charge			20		nC
R <sub>g</sub>	Gate Resistance	V <sub>DS</sub> = 0 V, Scan F mode		2.0		Ω
<b>Drain-Source Diode Characteristics and Maximum Ratings</b>						
I <sub>S</sub>	Maximum Continuous Drain-Source Diode Forward Current				80	A
I <sub>SM</sub>	Maximum Pulsed Drain-Source Diode Forward Current				280	A
V <sub>SD</sub>	Diode Forward Voltage	V <sub>GS</sub> = 0 V, I <sub>S</sub> = 40 A			1.2	V
I <sub>rrm</sub>	Reverse recovery current	I <sub>S</sub> = 40A, V <sub>GS</sub> = 0V, dI <sub>F</sub> /dt = 100A/us		-1.4		A
T <sub>rr</sub>	Reverse recovery time			23		ns
Q <sub>rr</sub>	Reverse recovery charge			16		nC

Notes: 1. Repetitive Rating : Pulse width limited by maximum junction temperature

2. L = 0.95 mH, I<sub>AS</sub> = 32 A, V<sub>DD</sub> = 10V, R<sub>G</sub> = 25 Ω, Starting T<sub>J</sub> = 25°C

3. I<sub>SD</sub> ≤ 40A, di/dt = 100A/us, V<sub>DD</sub> ≤ BV<sub>DSS</sub>, Starting T<sub>J</sub> = 25°C

4. Pulse Test : Pulse width ≤ 300us, Duty cycle ≤ 2%

5. Essentially independent of operating temperature



### Typical Characteristics

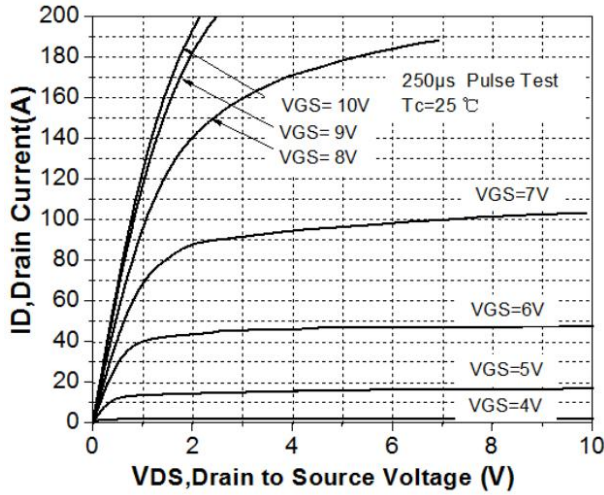

Figure 1. On-Region Characteristics

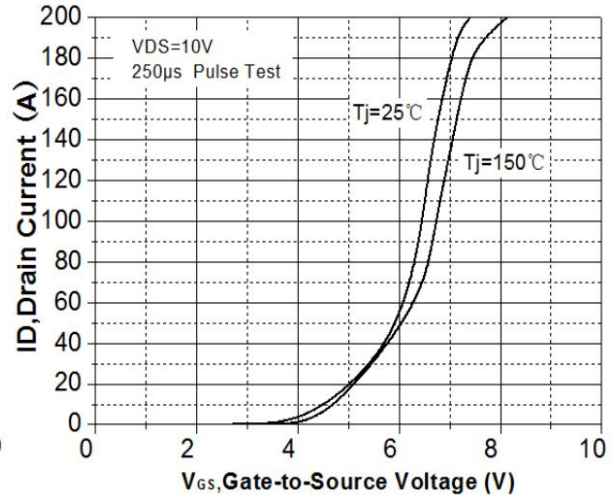

Figure 2. Transfer Characteristics

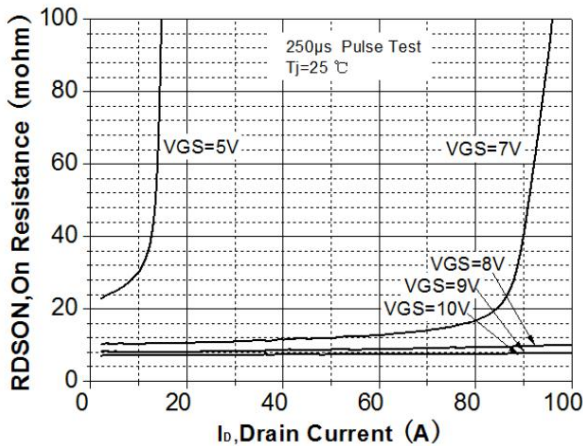

Figure 3. On-Resistance Variation vs Drain Current and Gate Voltage

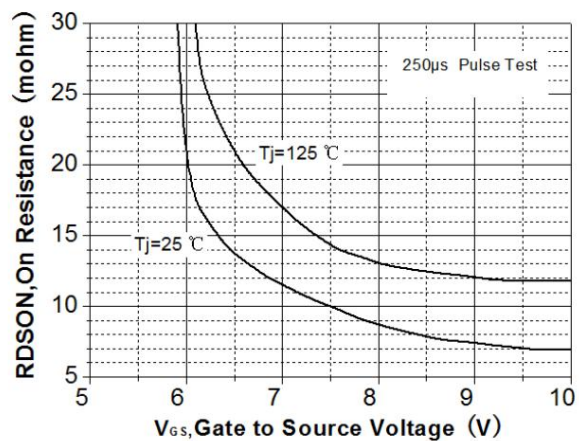

Figure 4. On-Resistance vs. Gate to Source Voltage

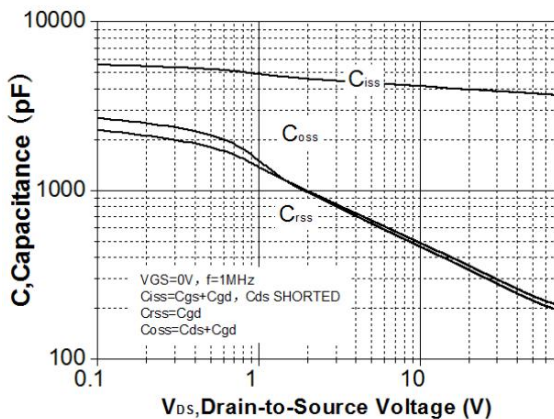

Figure 5. Capacitance Characteristics

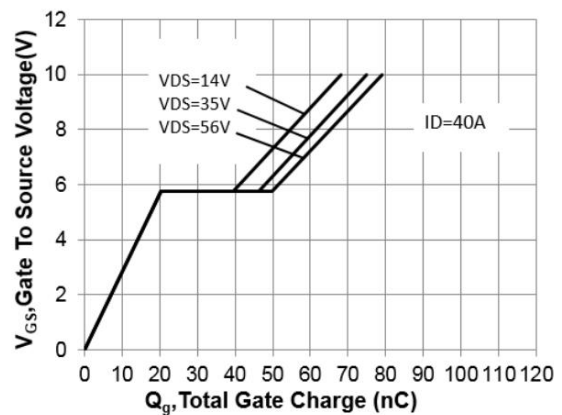

Figure 6. Gate Charge Characteristics

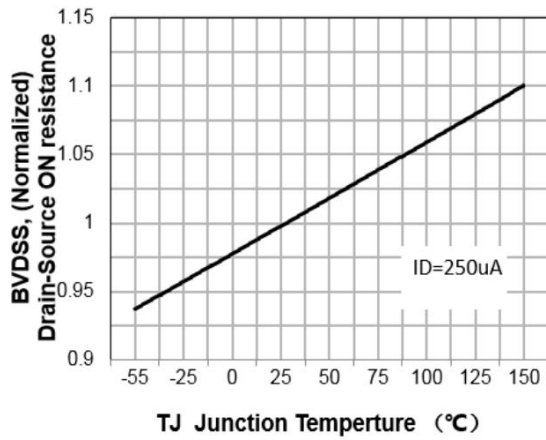

Figure 7. Breakdown Voltage Variation vs Temperature

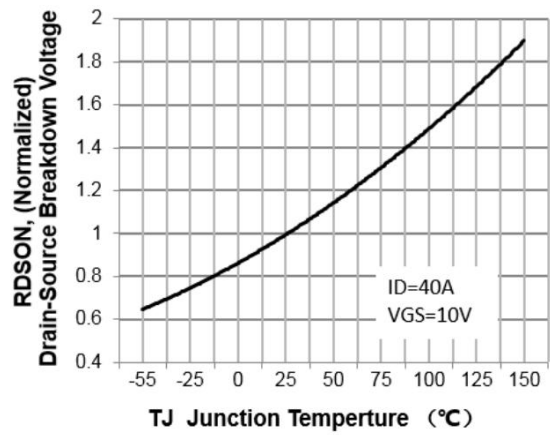

Figure 8. On-Resistance Variation vs Temperature

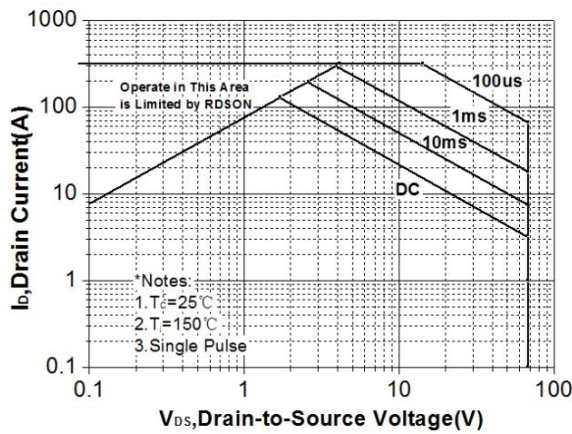

Figure 9. Maximum Safe Operating Area

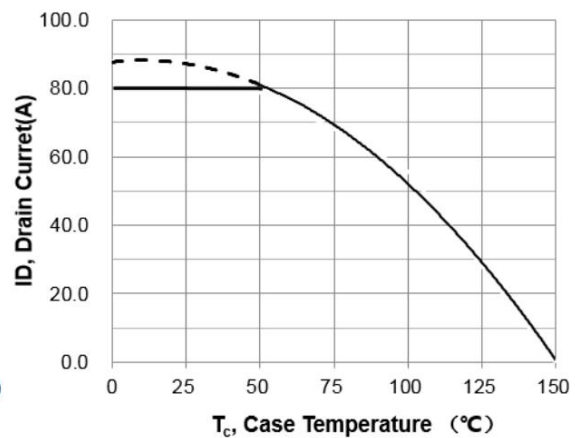

Figure 10. Maximum Drain Current vs Case Temperature

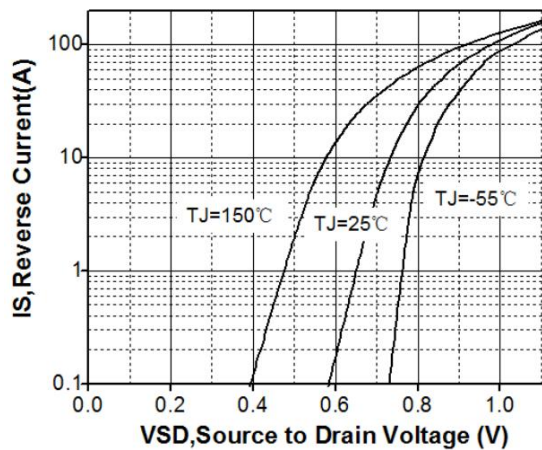

Figure 11. Body Diode Forward Voltage Vs Reverse Drain Current

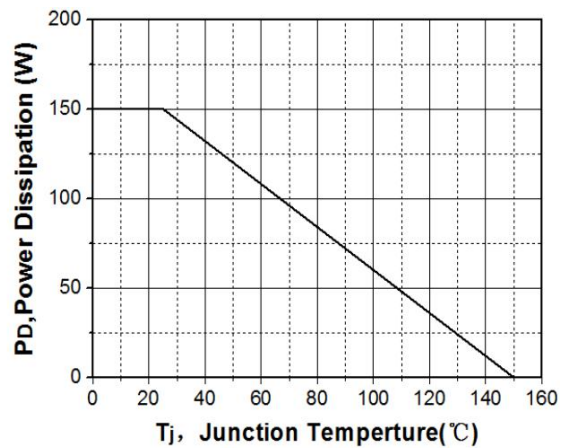

Figure 12. Power Dissipation vs Junction Temperature

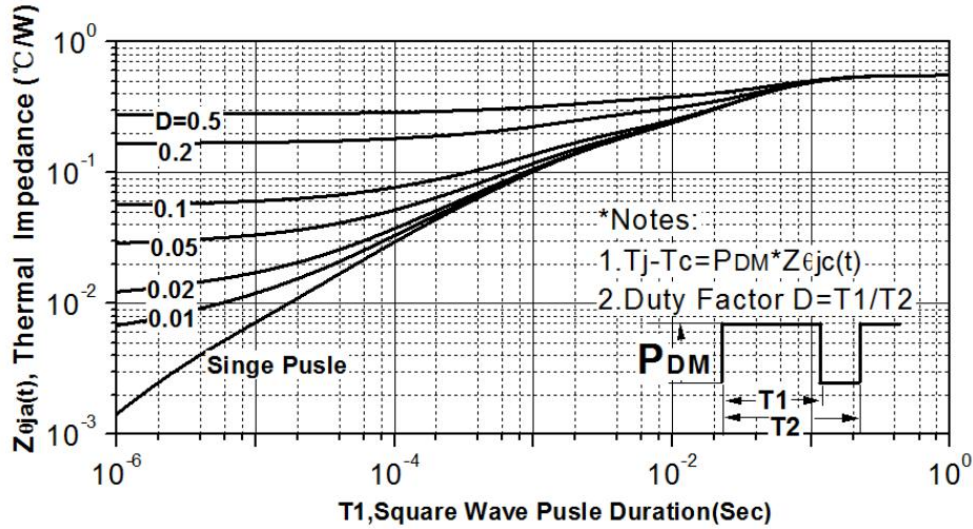

Figure 13. Transient Thermal Response Curve

### Test Circuit

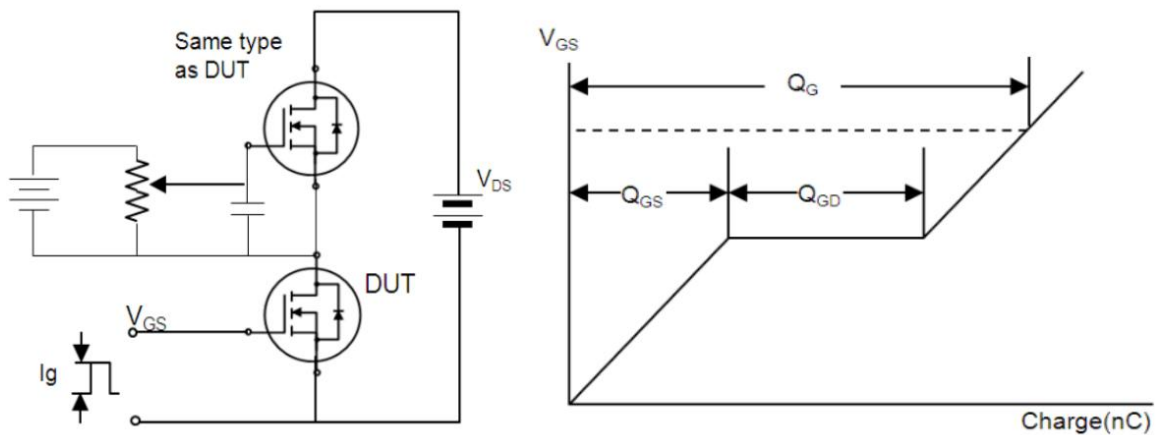

Figure 14. Gate charge test circuit & waveform

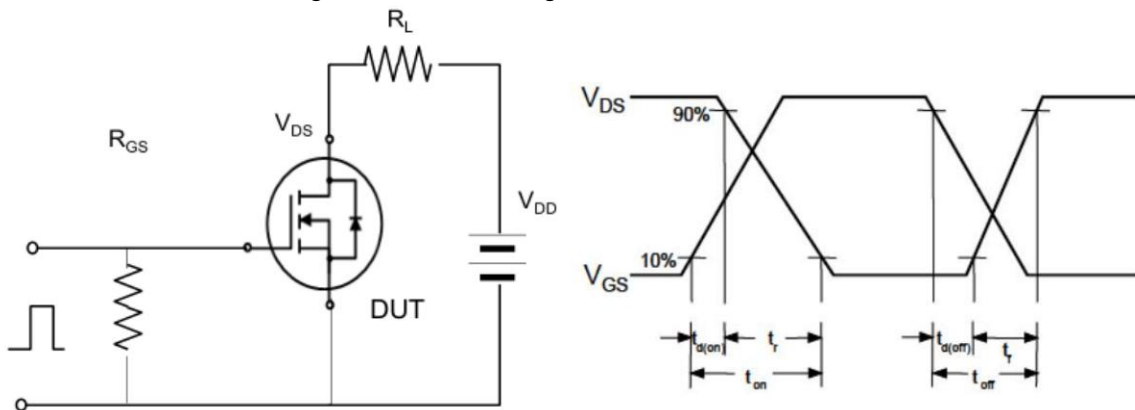

Figure 15. Switching time test circuit & waveform

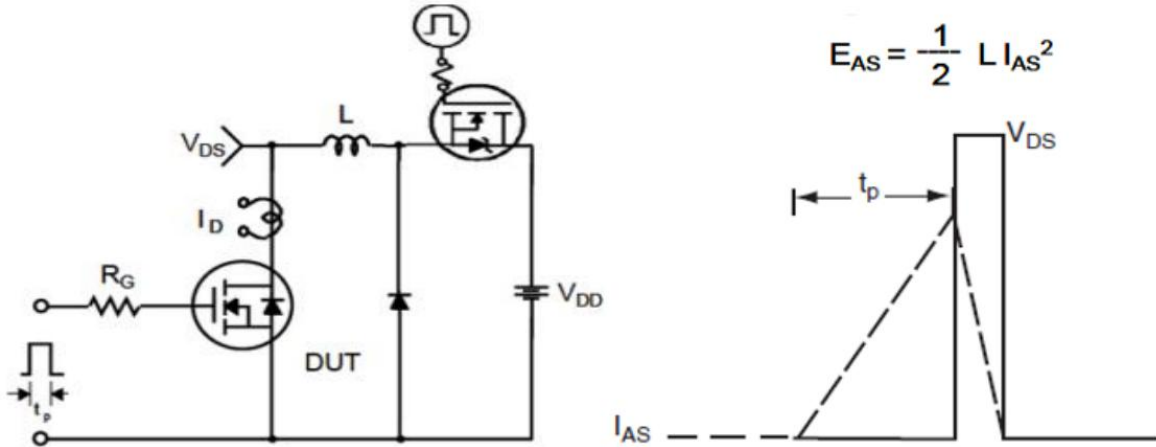

Figure 16. Unclamped Inductive switching test circuit & waveform

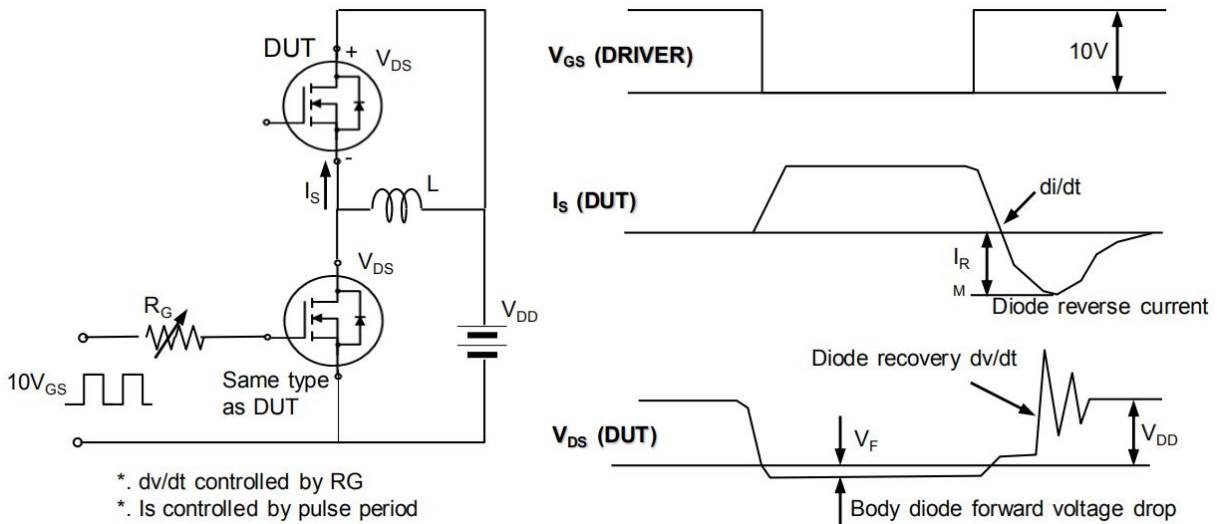
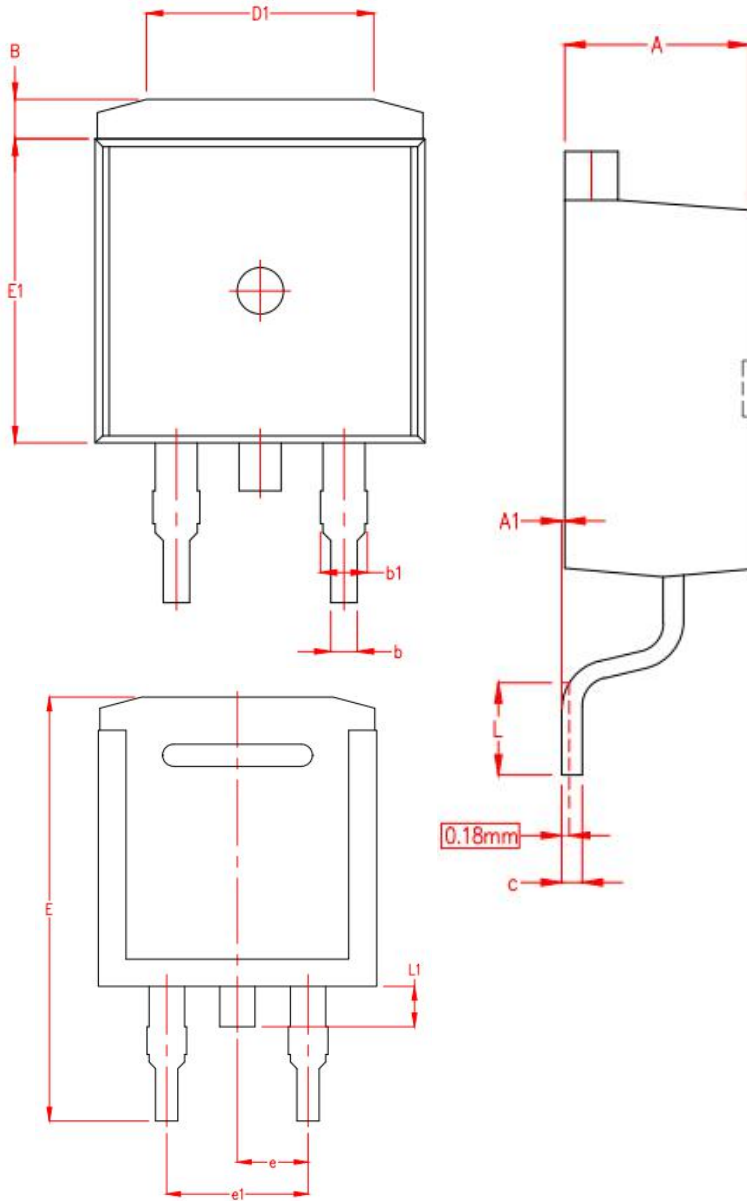

Figure 17. Peak diode recovery dv/dt test circuit & waveform



## TO-263 Package Information



SYMBOL	MILLIMETER		
	MIN	NOM	MAX
A	4.45	4.50	4.55
A1	0	0.07	0.15
B	1.08	1.20	1.32
b	0.80TYP.		
b1	1.24	1.27	1.30
c	0.48	0.50	0.52
D	9.95	10.00	10.05
D1	6.89REF.		
E	15.09	15.24	15.39
E1	9.15	9.20	9.25
e	2.51	2.54	2.57
e1	5.05	5.08	5.11
L	2.29	2.54	2.79