

SS8050 NPN Transistors

General description

SOT-23 Plastic-Encapsulate Transistors

SOT-23

FEATURES

- Complementary to SS8550
- Power Dissipation of 300mW
- High Stability and High Reliability

MECHANICAL DATA

- SOT-23 Small Outline Plastic Package
- Epoxy UL: 94V-0
- Mounting Position: Any

1. BASE
2. EMITTER
3. COLLECTOR



Marking: Y1

Maximum Ratings & Thermal Characteristics T_A = 25°C unless otherwise noted

Parameters	Symbol	Value	Unit
Collector-Base Voltage	V _{CB0}	40	V
Collector-Emitter Voltage	V _{CEO}	25	V
Emitter -Base Voltage	V _{EBO}	5	V
Collector Current-Continuous	I _c	1500	mA
Collector Power Dissipation	P _c	300	mW
Junction Temperature	T _j	150	°C
Storage Temperature	T _{stg}	-55-+150	°C
Thermal resistance From junction to ambient	R _{θJA}	417	°C/W

Electrical Characteristics T_A = 25°C unless otherwise noted

Parameter	Symbols	Test Condition	Limits		Unit
			Min	Max	
Collector-base breakdown voltage	V(BR)CBO	I _C =100uA, I _E =0	40		V
Collector-emitter breakdown voltage	V(BR)CEO	I _C =0.1mA, I _B =0	25		V
Emitter-base breakdown voltage	V(BR)EBO	I _E =100uA, I _C =0	5		V
Collector cut-off current	I _{CEO}	V _{CE} =20V, I _B =0		100	nA
Collector cut-off current	I _{CBO}	V _{CB} =40V, I _E =0		100	nA
Emitter cut-off current	I _{EBO}	V _{EB} =5V, I _C =0		100	nA
DC current gain	h _{FE} (1)	V _{CE} =1V, I _C =100mA	120	400	
	h _{FE} (2)	V _{CE} =1V, I _C =800mA	50		
Collector-emitter saturation voltage	V _{CE(sat)}	I _C =800mA, I _B =80mA		0.60	V
Base -emitter saturation voltage	V _{BE(sat)}	I _C =800mA, I _B =80mA		1.20	V
Transition frequency	f _t	V _{CE} =10V, I _C =50mA, f=30MHz	100		MHz

CLASSIFICATION OF h_{FE}(1)

RANK	L	H	J
RANGE	120-200	200-350	300-400

Typical characteristics

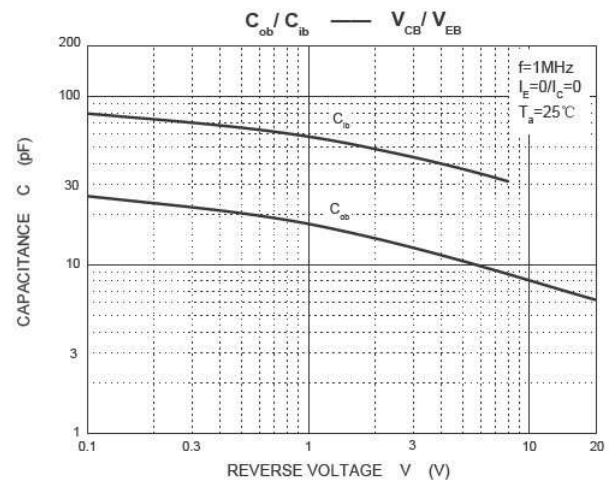
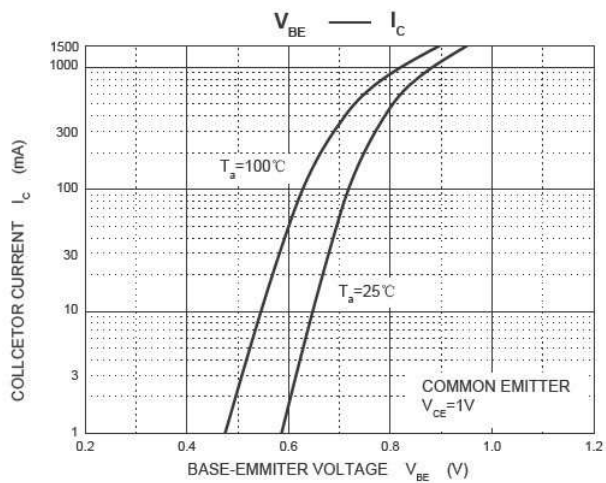
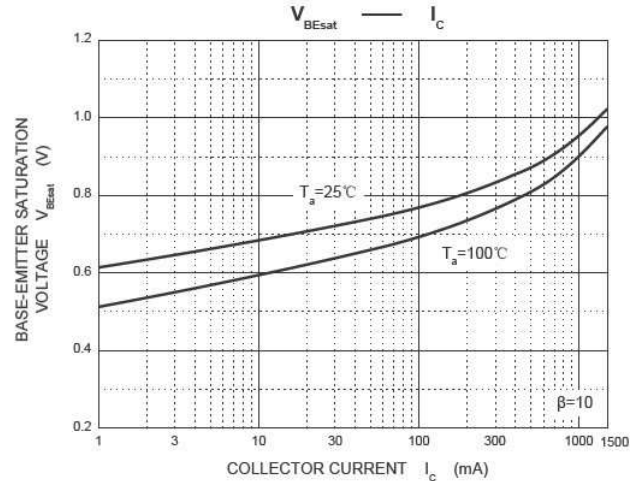
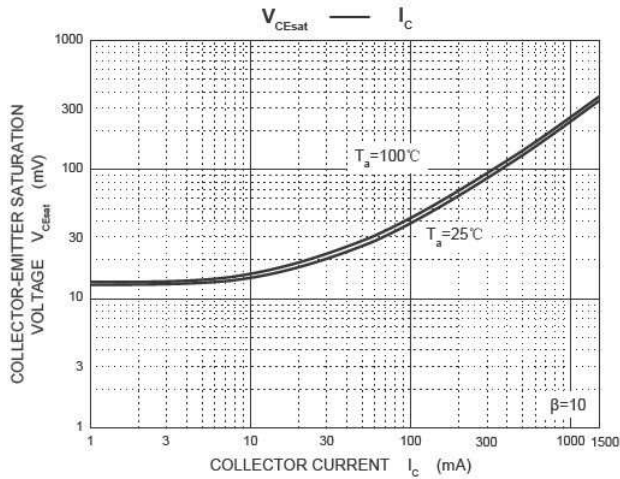
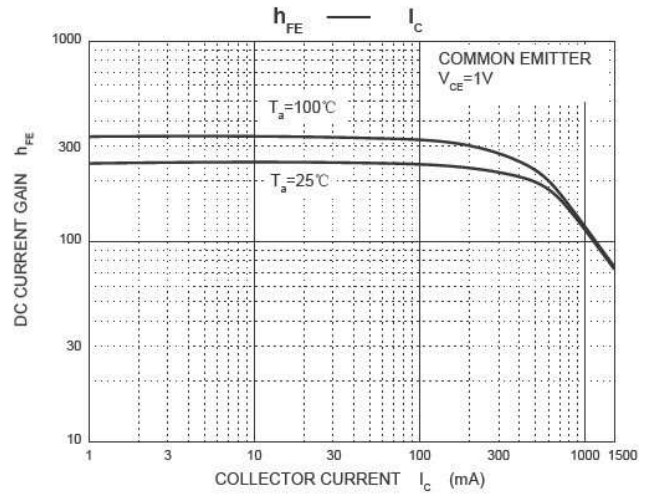
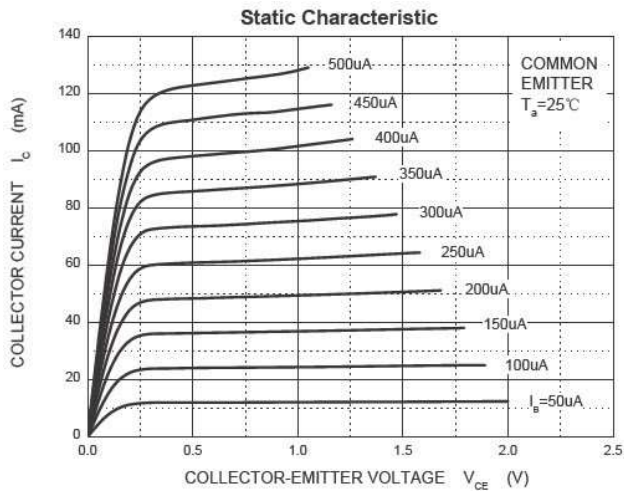

SS8050

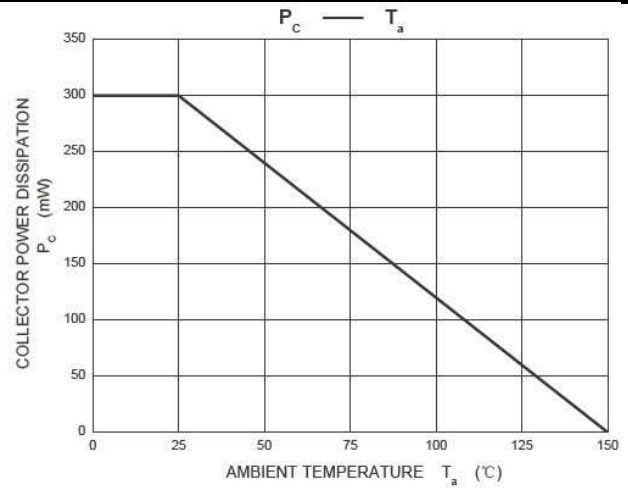
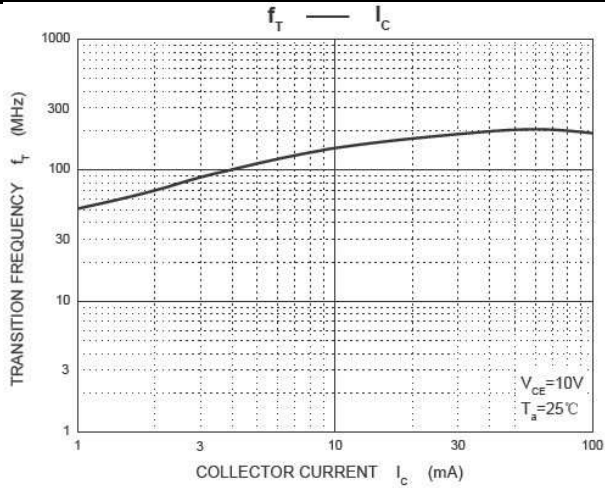

SOT-23 PACKAGE OUTLINE Plastic surface mounted package

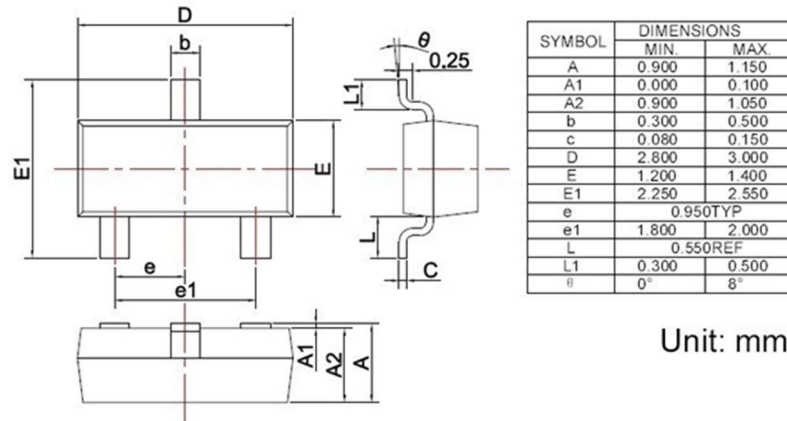

Recommended land dimensions for SOT-23 diode. Electrode patterns for PCBs

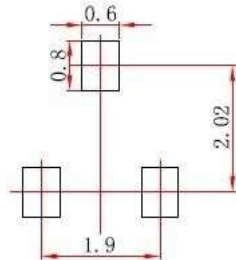

- Note:
1. Controlling dimension: In millimeters.
 2. General tolerance: ± 0.05 mm.
 3. The pad layout is for reference purposes only.

Important Notice and Disclaimer

DOESHARE has used reasonable care in preparing the information included in this document, but DOESHARE does not warrant that such information is error free. DOESHARE assumes no liability whatsoever for any damages incurred by you resulting from errors in or omissions from the information included herein.

DOESHARE no warranty, representation or guarantee regarding the documents, circuits and products specification, DOESHARE reservation rights to make changes for any documents, products, circuits and specifications at any time without notice.

Purchasers are solely responsible for the choice, selection and use of the DOESHARE products and services described herein, and DOESHARE assumes no liability whatsoever relating to the choice, selection or use of the products and services described herein.

No license, express or implied, by implication or otherwise under any intellectual property rights of DOESHARE.

Resale of DOESHARE products with provisions different from the statements and/or technical features set forth in this document shall immediately void any warranty granted by DOESHARE for the DOESHARE product or service described herein and shall not create or extend in any manner whatsoever, any liability of DOESHARE.