

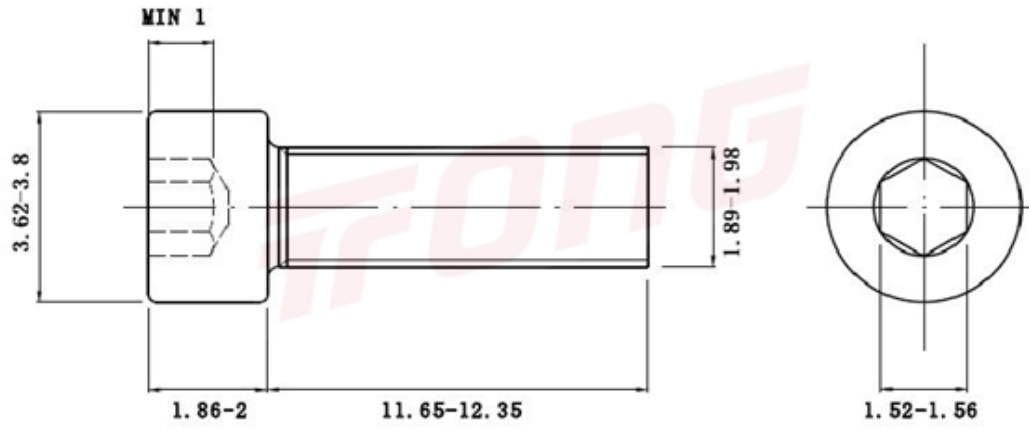

项目号 262516



*图纸仅供参考，请以实物为准

材质	304
标准	DIN912
规格	M2-0.4 X 12
项目号	262516
品名	内六角圆柱头螺钉(滚花)



项目号 262516

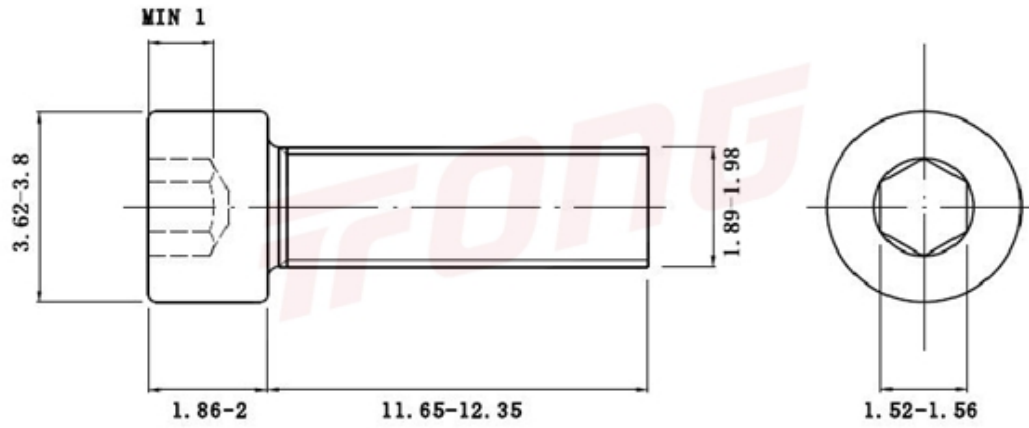

*图纸仅供参考，请以实物为准

材质	304
标准	DIN912
规格	M2-0.4 X 12
项目号	262516
品名	内六角圆柱头螺钉(滚花)