

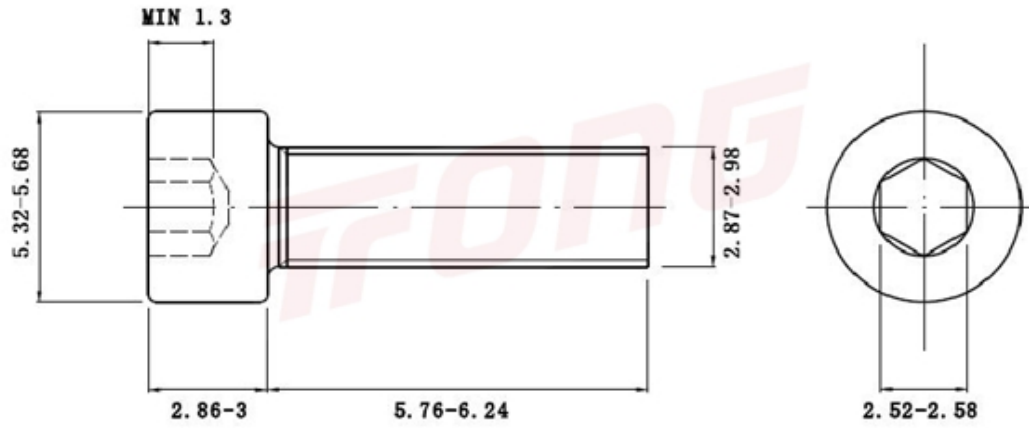

项目号 120351



*图纸仅供参考，请以实物为准

材质	304
标准	DIN912
规格	M3-0.5 X 6
项目号	120351
品名	内六角螺丝(滚花)



项目号 120351

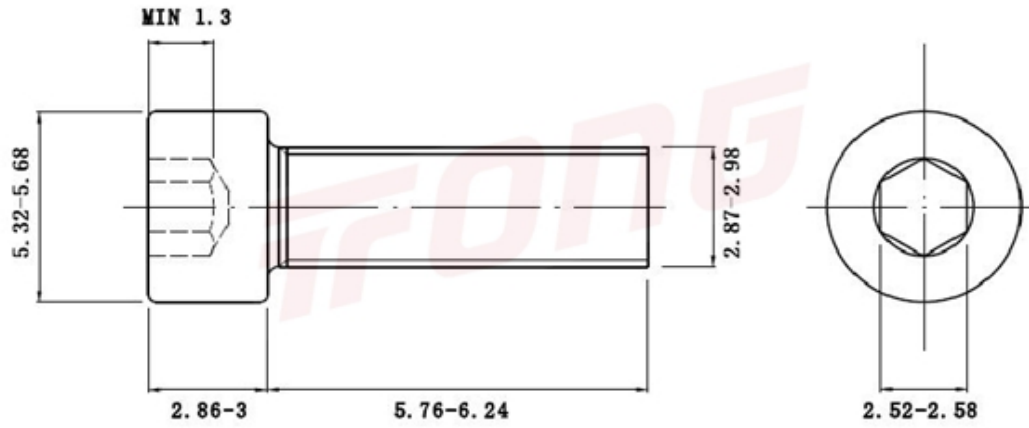

*图纸仅供参考，请以实物为准

材质	304
标准	DIN912
规格	M3-0.5 X 6
项目号	120351
品名	内六角螺丝(滚花)