

FH1810G

N-Channel Enhancement Mode Power MOSFET

Description

The FH1810G uses advanced trench technology and design to provide excellent $R_{DS(ON)}$ with low gate charge. It can be used in a wide variety of applications.

Application

- Motor drivers
- Power switching application
- DC/DC Converters In Computing
- Isolated DC/DC Converters In Telecom and Industrial

General Features

V_{DSS}	I_D	$R_{DS(ON)}(MAX)$
100V	80A	4.9m Ω @VGS=10V

- High density cell design for ultra low Rdson
- Fully characterized avalanche voltage and current
- Good stability and uniformity with high E_{AS}
- Excellent package for good heat dissipation

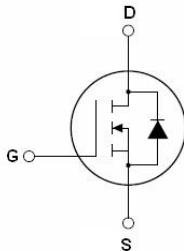

Schematic diagram



Marking and pin Assignment

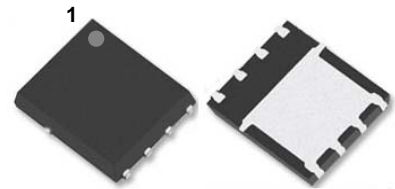

PDFN5X6-8L top and bottom view

Limiting Values

Symbol	Parameter	Conditions	Value	Unit
V_{DS}	Drain-Source Voltage	$T_C = 25\text{ }^\circ\text{C}$	100	V
V_{GS}	Gate-Source Voltage	$T_C = 25\text{ }^\circ\text{C}$	± 20	V
I_D^*	Drain Current	$T_C = 25\text{ }^\circ\text{C}, V_{GS} = 10\text{ V}$	80	A
I_{DM}^{***}	Pulsed Source Current	$T_C = 25\text{ }^\circ\text{C}, V_{GS} = 10\text{ V}$	240	A
P_{tot}^*	Total Power Dissipation	$T_C = 25\text{ }^\circ\text{C}$	35	W
T_{stg}	Storage Temperature		-55~150	$^\circ\text{C}$
T_J	Junction Temperature		150	$^\circ\text{C}$
I_S	Diode Forward Current	$T_C = 25\text{ }^\circ\text{C}$	80	A
$R_{\theta JA}^*$	Thermal Resistance- Junction to Ambient		62.5	$^\circ\text{C} / \text{W}$
$R_{\theta JC}^*$	Thermal Resistance- Junction to Case		3.5	
E_{AS}^*	SinglePulsed-Avalanche Energy	$T_J = 25\text{ }^\circ\text{C}, L = 1.0\text{ mH}, R_G = 25\text{ }^\circ\Omega, V_{GS} = 10\text{ V}$	212	mJ

Notes :

* Surface Mounted on 1 in² pad area, $t \leq 10\text{ sec}$

** Pulse width $\leq 300\text{ }\mu\text{s}$, duty cycle $\leq 2\%$

*** limited by bonding wire

6. Electrical Characteristics (T_A = 25 °C Unless Otherwise Noted)

Symbol	Parameter	Conditions	Min	Typ	Max	Unit
Static Characteristics						
BV _{DSS}	Drain-Source Breakdown Voltage	V _{GS} = 0 V, I _D = 250 μA	100	-	-	V
V _{GS(th)}	Gate Threshold Voltage	V _{DS} = V _{GS} , I _{DS} = 250 μA	1	-	3	V
I _{DSS}	Zero Gate Voltage Source Current	V _{DS} = 80 V, V _{GS} = 0 V	-	-	1	μA
I _{GSS}	Gate Leakage Current	V _{GS} = ± 20 V, V _{DS} = 0 V	-	-	± 100	nA
R _{DS(on)} ^a	Drain-Source On-State Resistance	V _{GS} = 10 V, I _D = 50 A	-	4.2	4.9	mΩ
		V _{GS} = 4.5 V, I _D = 30 A	-	5.8	7.8	
Diode Characteristics						
V _{SD} ^a	Diode Forward Voltage	I _{SD} = 50 A, V _{GS} = 0 V	-	-	1.3	V
t _{rr}	Reverse Recovery Time	I _{SD} = 50 A, dI _{SD} /dt = 100 A/μs	-	82	-	nS
Q _{rr}	Reverse Recovery Charge		-	98	-	nC
Dynamic Characteristics^b						
C _{iss}	Input Capacitance	V _{GS} = 0 V, V _{DS} = 50 V Frequency = 1 MHz	-	3530	-	pF
C _{oss}	Output Capacitance		-	582	-	
C _{rss}	Reverse Transfer Capacitance		-	40	-	
t _{d(on)}	Turn-on Delay Time	V _{DS} = 50 V, V _{GEN} = 10 V, R _G = 3.9 Ω, R _L = 1 Ω, I _{DS} = 50 A	-	12	-	nS
t _r	Turn-on Rise Time		-	48	-	
t _{d(off)}	Turn-off Delay Time		-	55	-	
t _f	Turn-off Fall Time		-	59	-	
Gate Charge Characteristics^b						
Q _g	Total Gate Charge	V _{DS} = 50 V, V _{GS} = 10 V, I _{DS} = 50 A	-	71	-	nC
Q _{gs}	Gate-Source Charge		-	15	-	
Q _{gd}	Gate-Drain Charge		-	18	-	

Notes :

a : Pulse test ; pulse width ≤ 300 μs, duty cycle ≤ 2 %

b : Guaranteed by design, not subject to production testing

7. Typical Characteristics (Cont.)

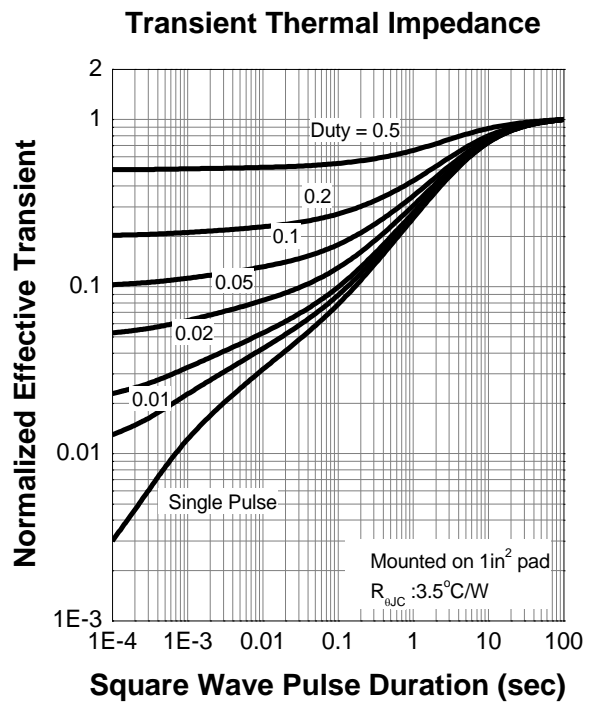
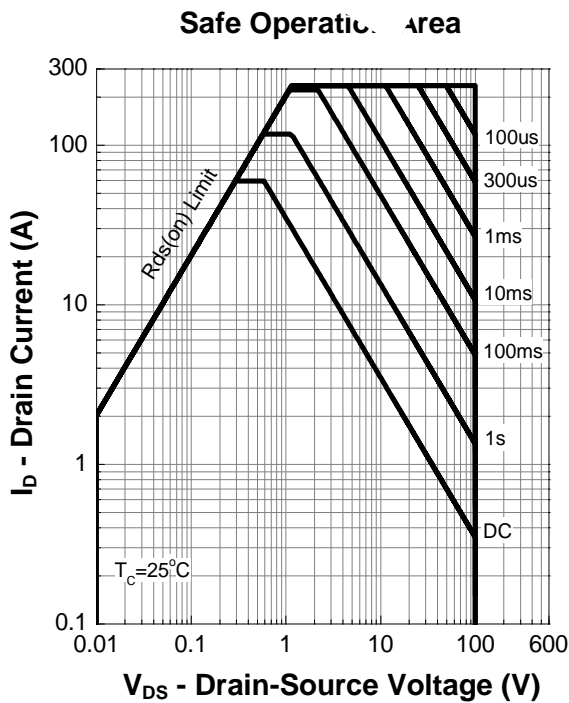
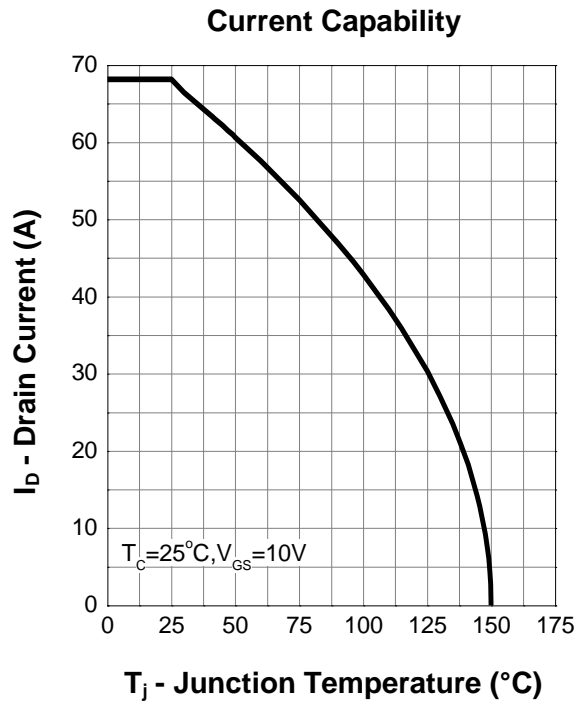
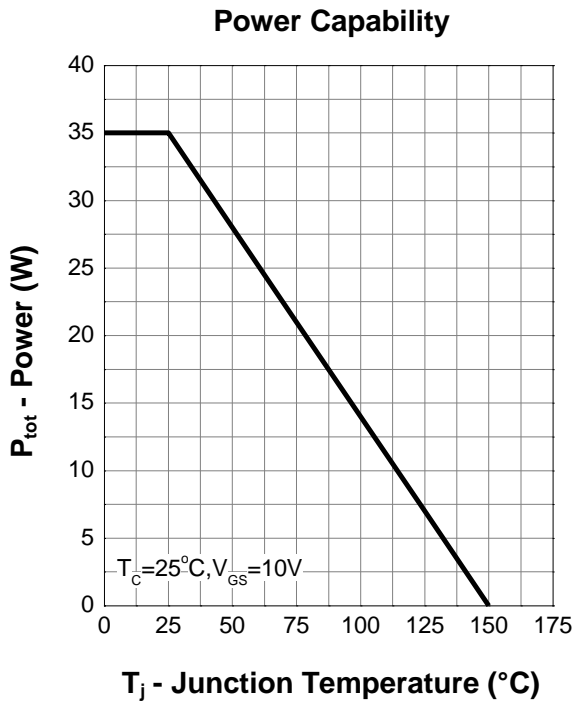

7. Typical Characteristics (Cont.)

Output Characteristics

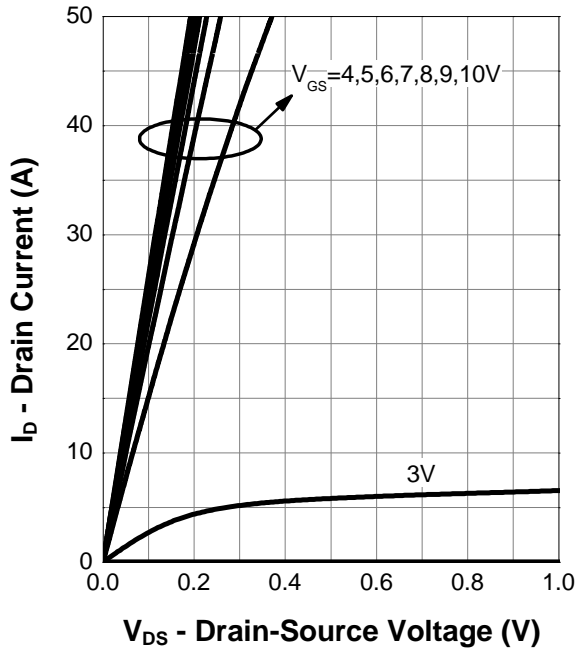

On Resistance

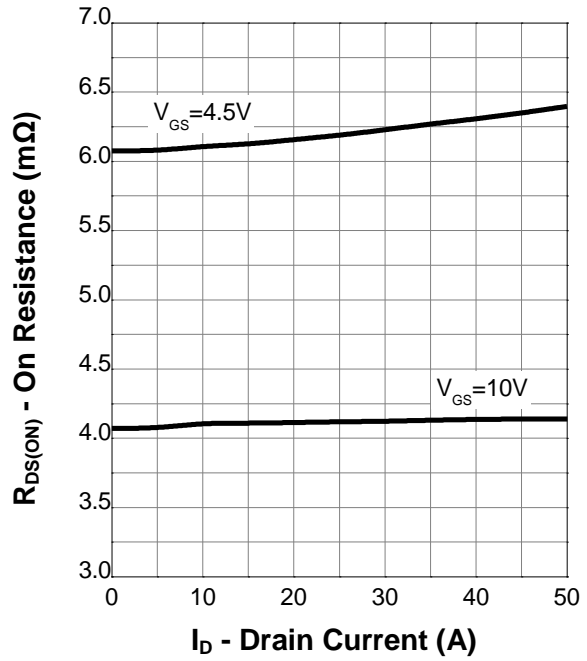

Transfer Characteristics

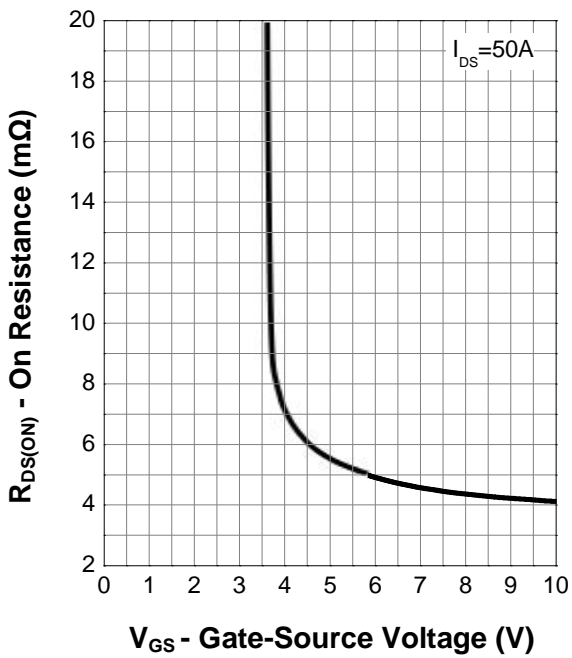

Normalized Threshold Voltage

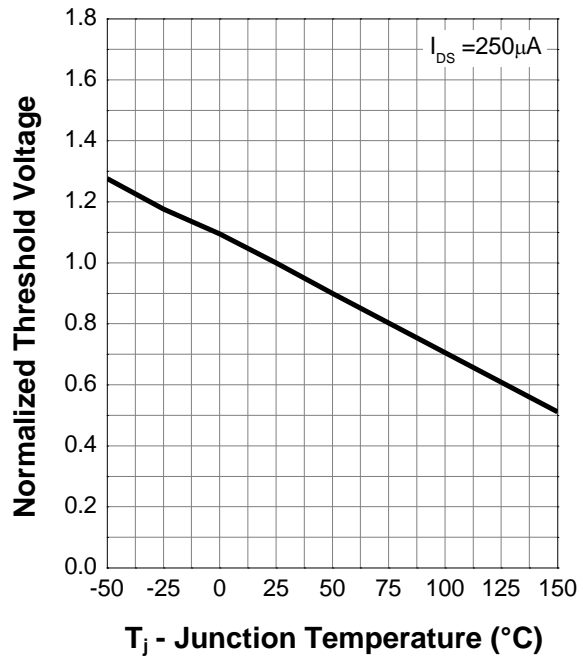

7. Typical Characteristics (Cont.)

Normalized On Resistance

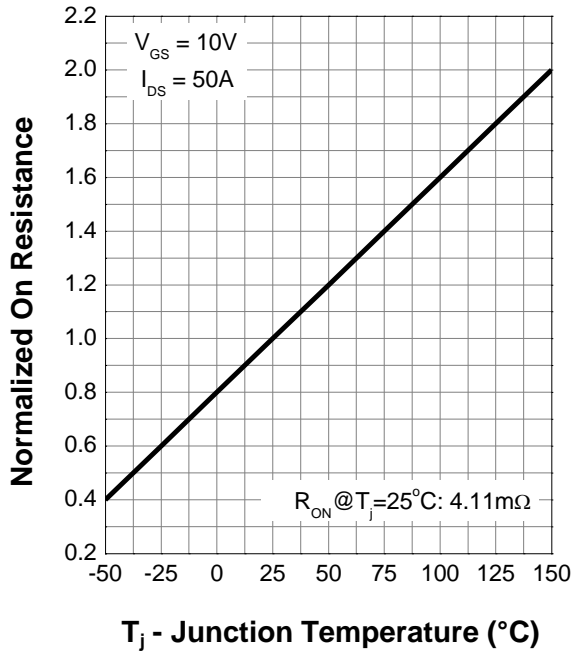

Diode Forward Current

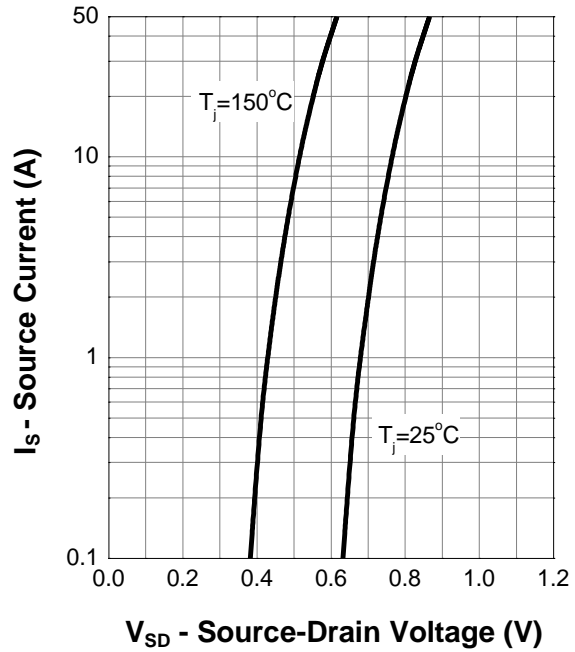

Capacitance

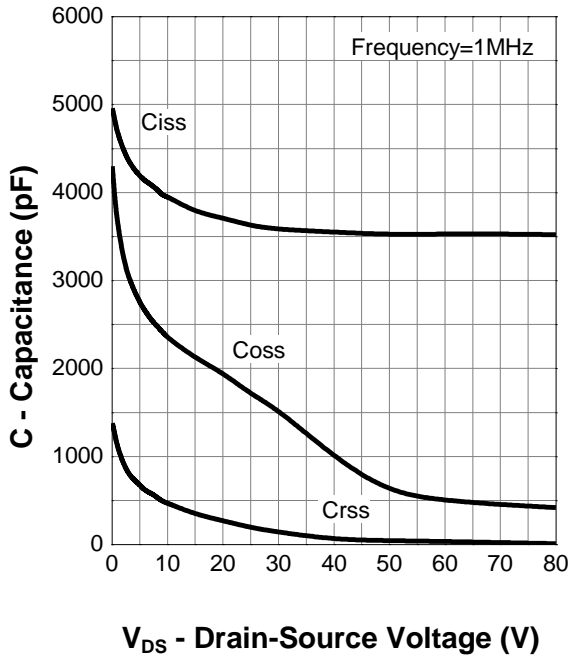

Gate Charge

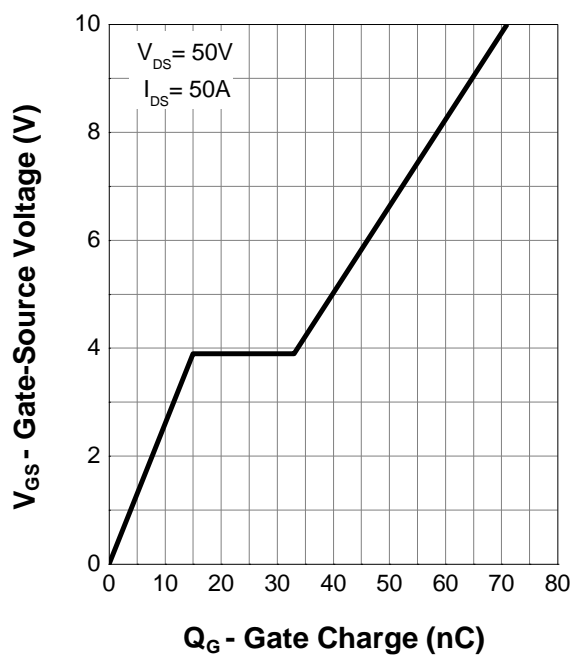

Package Information :PDFN5x6-8L

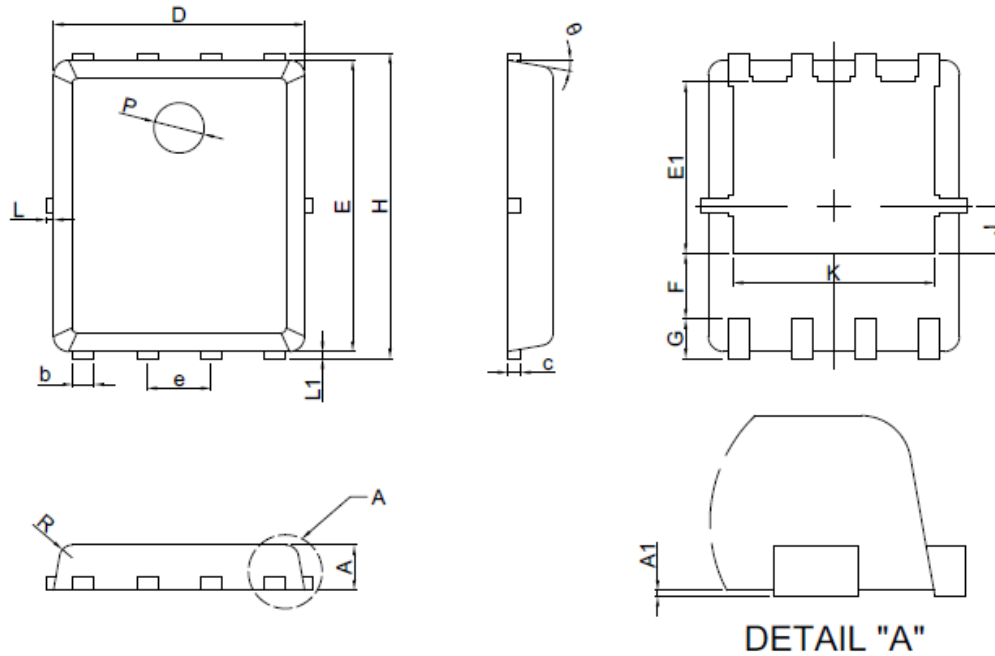

Symbol	Dimensions In Millimeters	
	MIN.	MAX.
A	0.80	1.00
A1	0.00	0.05
b	0.35	0.49
c	0.254REF	
D	4.80	5.20
F	1.40REF	
E	5.60	5.90
e	1.27BSC	
H	5.80	6.20
L1	0.10	0.18
G	0.60REF	
K	4.00REF	
L	-	0.15
J	0.95BSC	
P	1.00REF	
E1	3.40REF	
θ	6°	14°
R	0.25REF	