

Features

- 2μA Ground Current at no Load
- ±2% Output Accuracy
- 200mA Output Current
- Wide Operating Input Voltage Range: 2V to 36V
- Dropout Voltage: 0.65V at 100mA ($V_{OUT}=5V$)
- Support Fixed Output Voltage 1.8V, 3.3V, 5V, 9V, 12V
- Stable with Ceramic or Tantalum Capacitor
- Current Limit Protection
- Over-Temperature Protection
- SOT-23-5 Package Available

Applications

- Portable, Battery Powered Equipment
- Low Power Microcontrollers
- Laptop, Palmtops and PDAs
- Wireless Communication Equipment
- Audio/Video Equipment
- Car Navigation Systems
- Industrial Controls
- Weighting Scales
- Meters
- Home Automation

Ordering Information

TPRT9069-50GB

GB:SOT23-5 Package

Output voltage: 12=1.2V
15=1.5V
18=1.8V
30=3.0V
33=3.3V
50=5.0V
A9=5.0V
B2=12V

Marking:	TPRT9069-50GB	Marking:	PH50
	TPRT9069-33GB	Marking:	PH33
	TPRT9069-30GB	Marking:	PH30
	TPRT9069-12GB	Marking:	PH12
	TPRT9069-xxGB	Marking:	PHxx

PIN CONFIGURATION

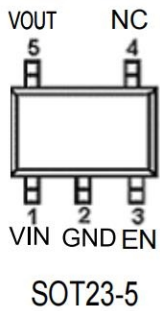

Pin No	Pin Name	Pin Function
1	VIN	Input of Supply Voltage.
2	GND	Ground
3	EN	Enable Control Input.
4	NC	No Internal Connection.
5	VOUT	Output of the Regulator

Typical Application Circuit

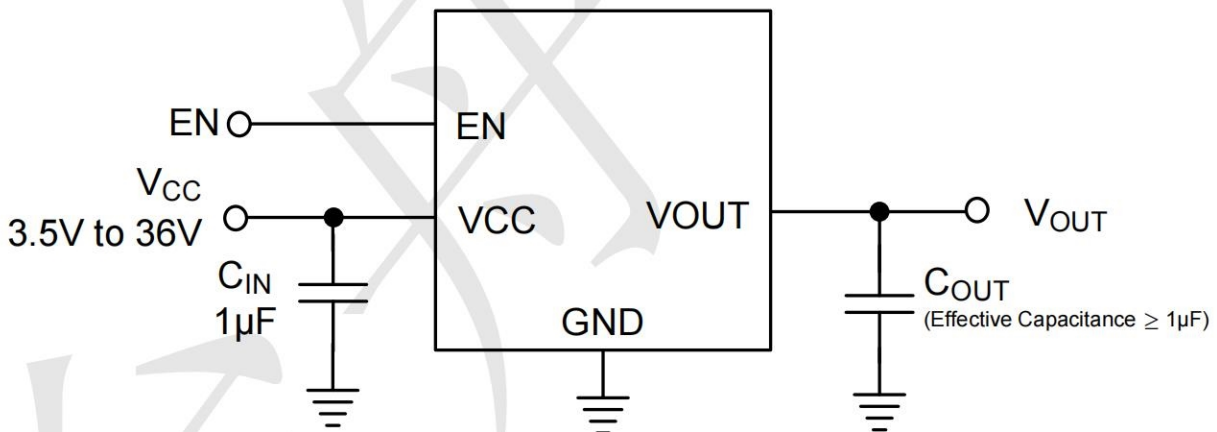
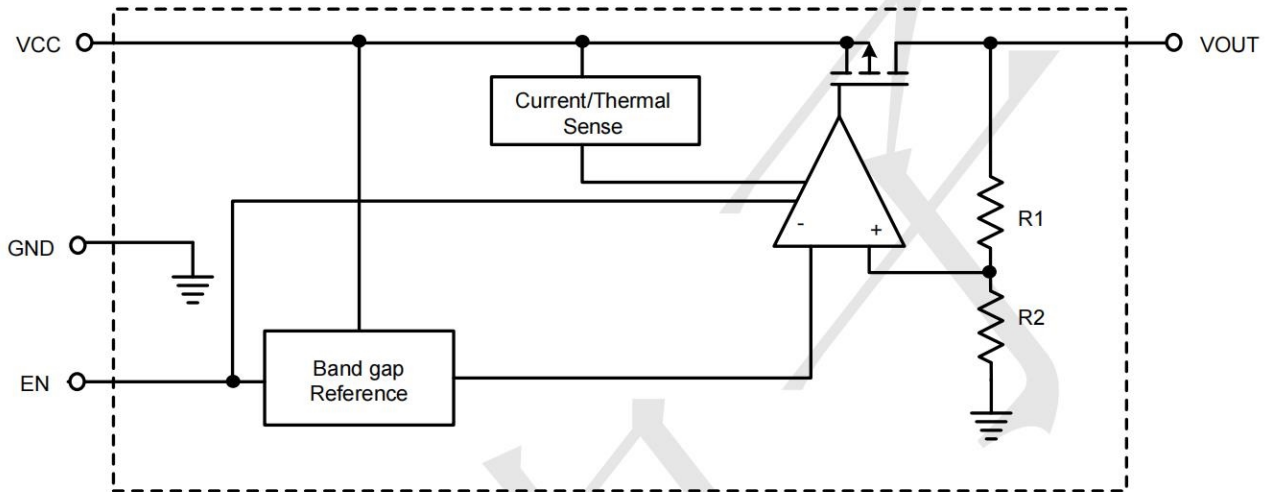

Figure 1: Application circuit of Fixed V_{OUT} LDO with enable and sense functions



BLOCK DIAGRAM



Absolute Maximum Ratings

VIN Pin to GND Pin Voltage	-0.3V to 40V
VOUT Pin to GND Pin Voltage Vout 9V,12V	-0.3V to 14V
Vout 1.2V,2.8V,3.3V,5.0V	-0.3V to 6.0V
VOUT Pin to VIN Pin Voltage	-40V to 0.3V
Storage Temperature Range	-60°C~150°C
Lead Temperature (Soldering, 10 sec)	260°C
Junction Temperature	150°C
Operating Ambient Temperature Range T _A	-40°C~85°C
SOT-23-5, θ _{JA}	218.1°C/W
SOT-23-5, θ _{JC}	28.5°C/W

(Assume no Ambient Airflow, no Heatsink)

Recommended Operating Conditions

Supply Input Voltage	3.5V to 36V
Junction Temperature Range	-40°C to 125°C
Ambient Temperature Range	-40°C to 85°C

Electrical Characteristics

($V_{IN}=15V$, $V_{EN}=5V$, $T_A=25^{\circ}C$, unless otherwise specified) (Note 1)

Parameter	Symbol	Test Conditions	Min	Typ	Max	Unit
Supply Voltage	V_{IN}		2	--	36	V
DC Output Voltage Accuracy		$I_{LOAD} = 0.1mA$	-2		2	%
Dropout Voltage ($I_{LOAD} = 100mA$)	V_{DROP}	$V_{OUT} \geq 5V$	--	0.66		V
	$V_{DROP_3.3V}$	$V_{OUT} = 3.3V$		0.75		
	$V_{DROP_1.8V}$	$V_{OUT} = 1.8V$		1		
Ground Current ($I_{LOAD} = 0mA$)	I_Q	$V_{OUT} \leq 5V$		2		μA
	I_{QH}	$5V < V_{OUT} \leq 12V$		4.5		
Shutdown Ground Current	I_{SD}	$V_{EN} = 0V$, $V_{OUT} = 0V$		0.01	0.5	μA
V_{OUT} Shutdown Leakage Current	I_{LEAK}			0.01	0.5	μA
Enable Threshold Voltage	V_{IH}	EN Rising			2	V
	V_{IL}	EN Falling	0.6			
EN Input Current	I_{EN}	$V_{EN} = 36V$		10	100	nA
Line Regulation	Δ_{LINE}	$I_{LOAD} = 1mA$, $5 \leq V_{IN} \leq 36V$	--	0.3		%
Load Regulation	Δ_{LOAD}	$1mA \leq I_{LOAD} \leq 0.2A$		0.1		%
Output Current Limit	I_{LIM}	$V_{OUT} = 0$	200	300		mA
Power Supply Rejection Ratio	PSRR	$V_{OUT} = 5V$, $I_{LOAD} = 1mA$, $V_{IN} = 12V$, $f = 100Hz$		70		dB
Thermal Shutdown Temperature	T_{SD}	$I_{LOAD} = 10mA$	--	160	--	$^{\circ}C$
Thermal Shutdown Hysteresis	ΔT_{SD}		15			$^{\circ}C$

Note 1. Specifications are production tested at $T_A=25^{\circ}C$. Specifications over the $-40^{\circ}C$ to $85^{\circ}C$ operating temperature range are assured by design, characterization and correlation with Statistical Quality Controls (SQC).



Typical Operating Characteristics

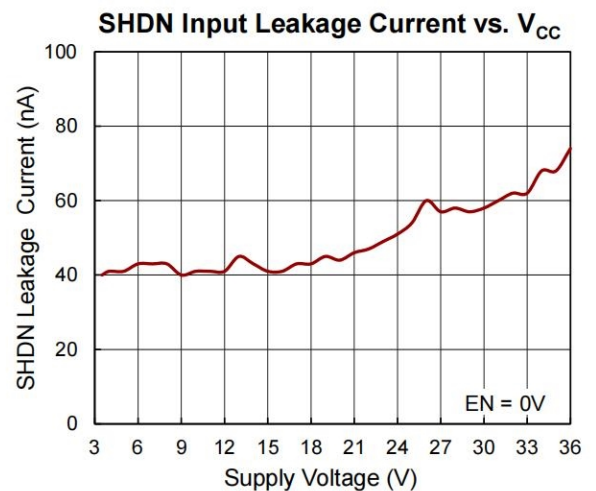
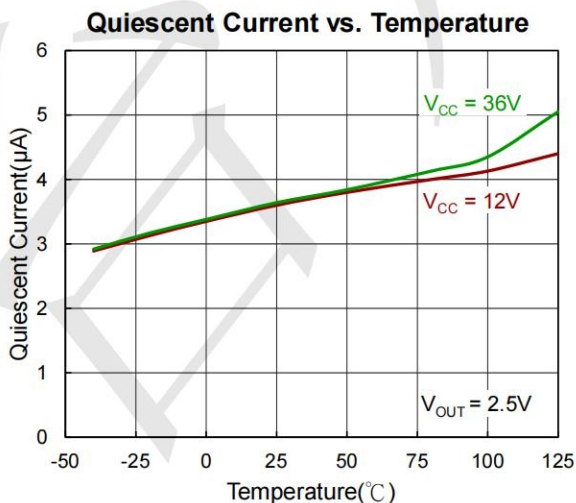
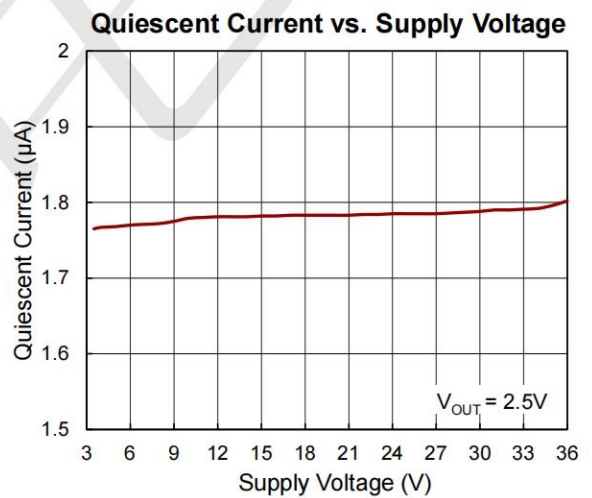
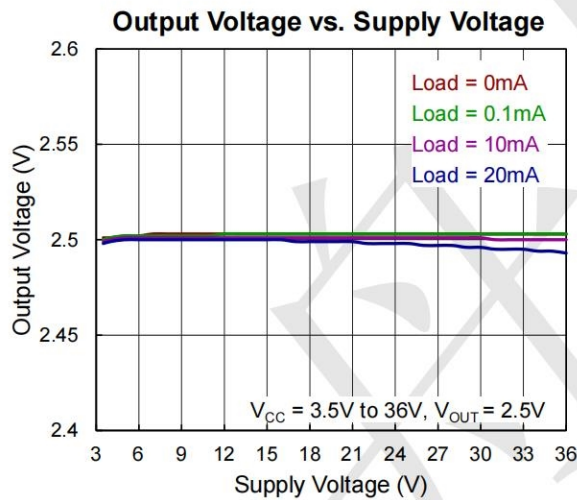
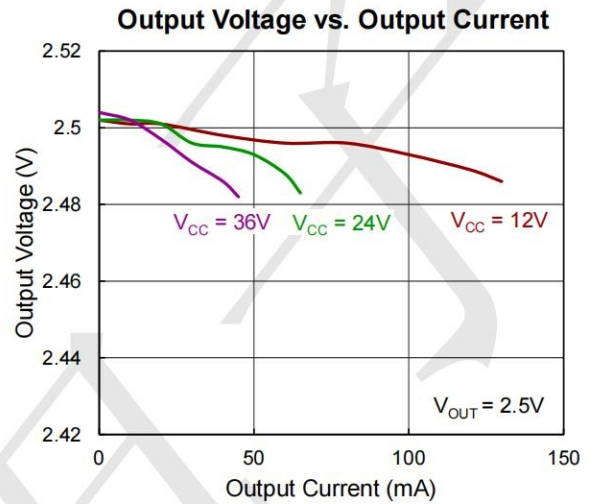
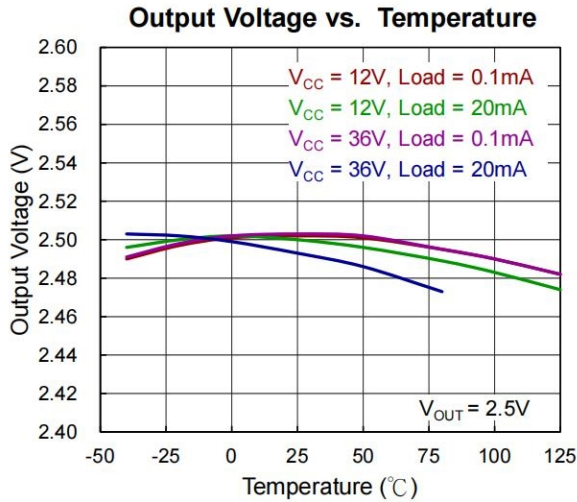



SHDN Leakage Input Current vs. Temp.

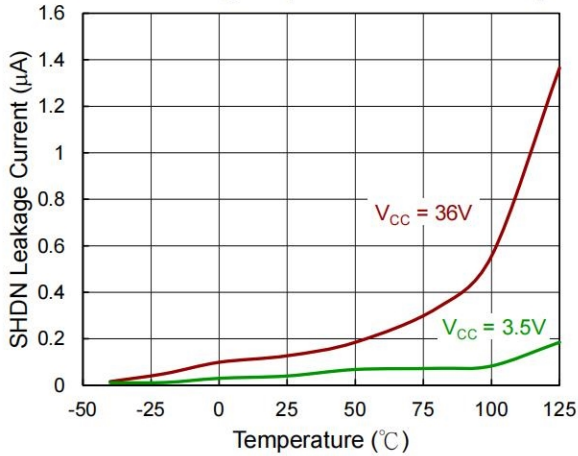

Enable Threshold vs. Supply Voltage

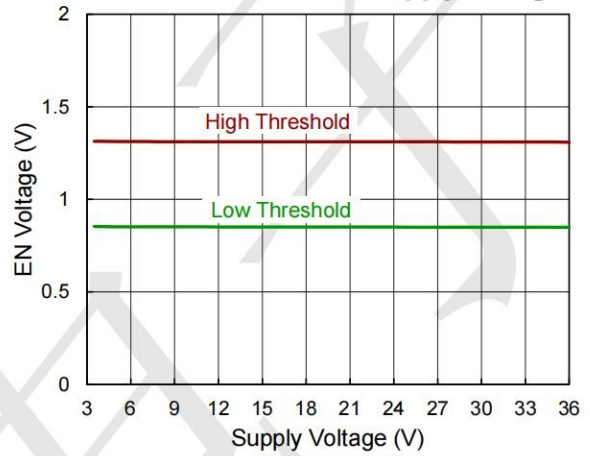

Enable Threshold vs. Temperature

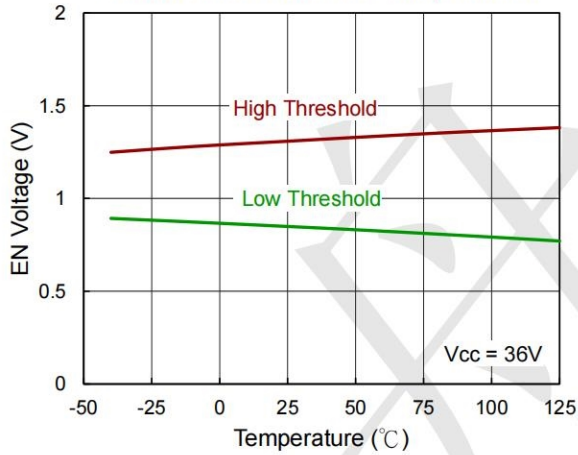

Dropout Voltage vs. Temperature

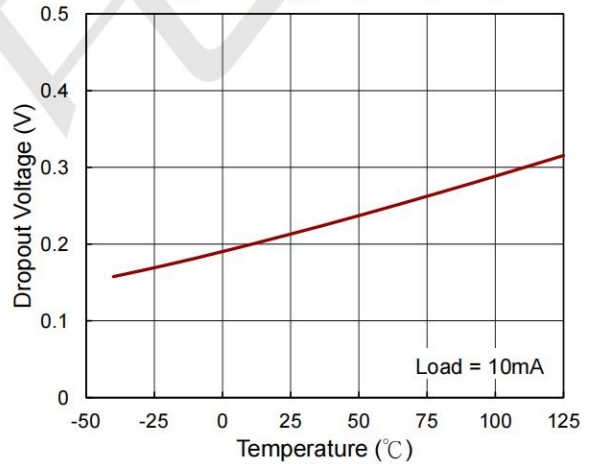

Current Limit vs. Temperature

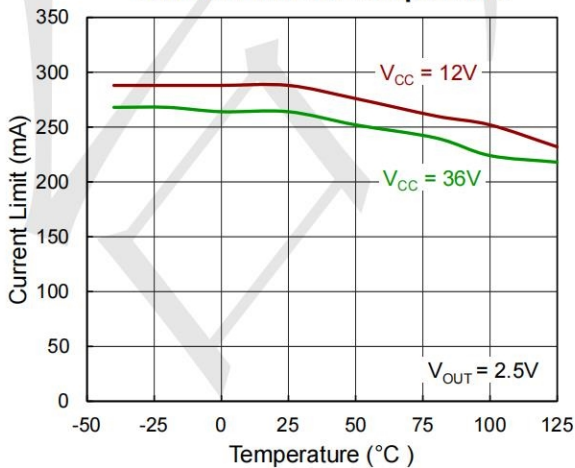

PSRR vs. Frequency

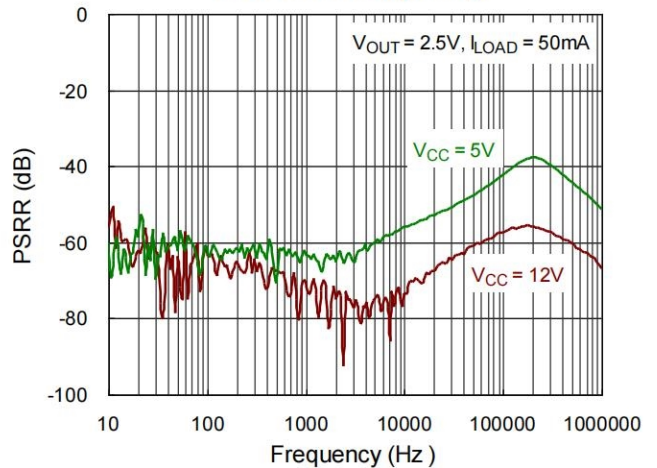

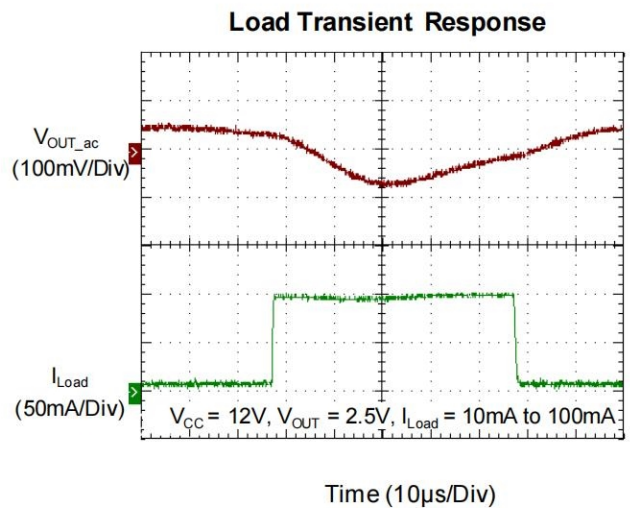
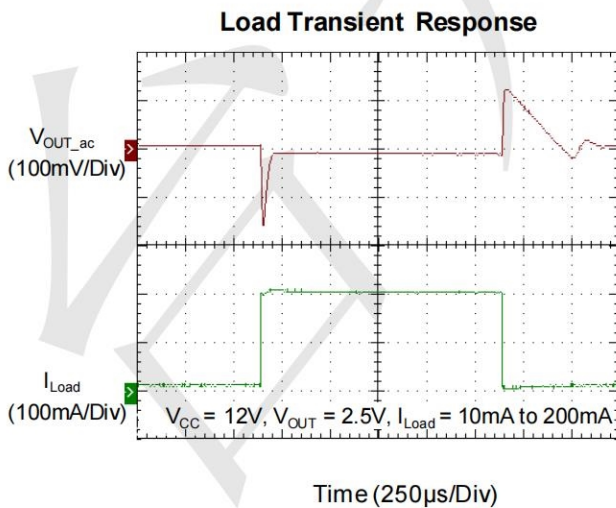
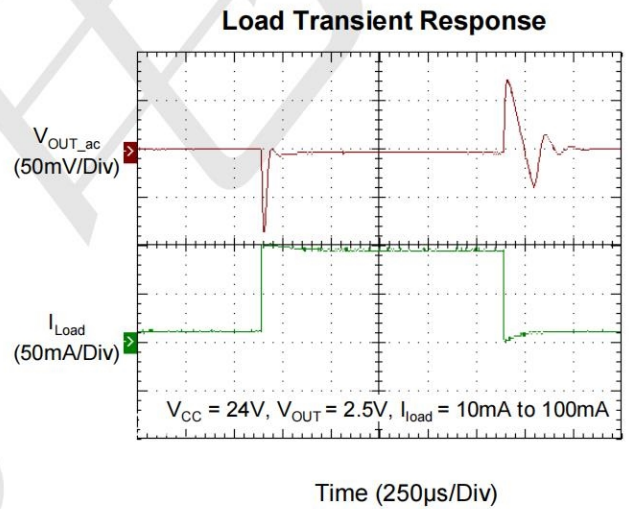
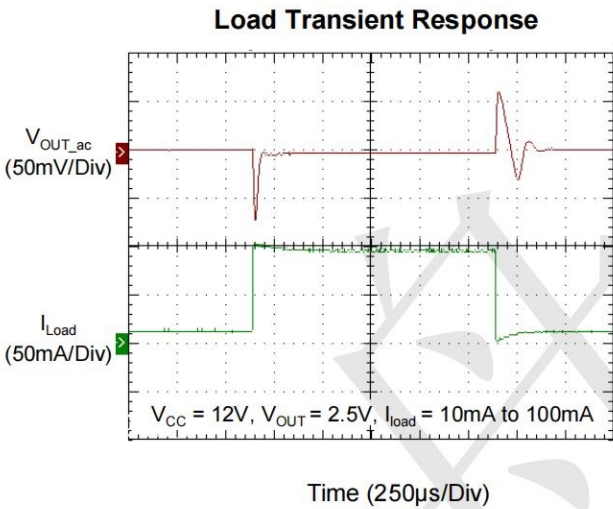
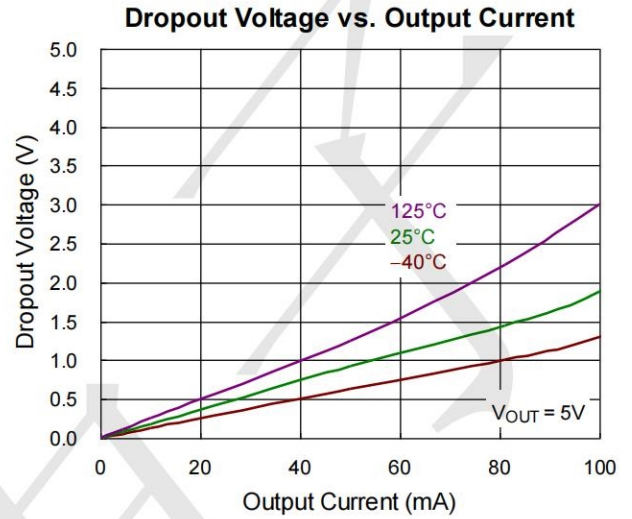
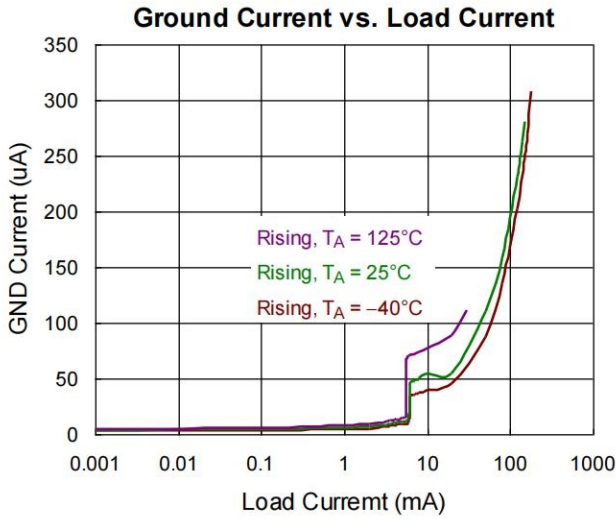



Line Transient Response

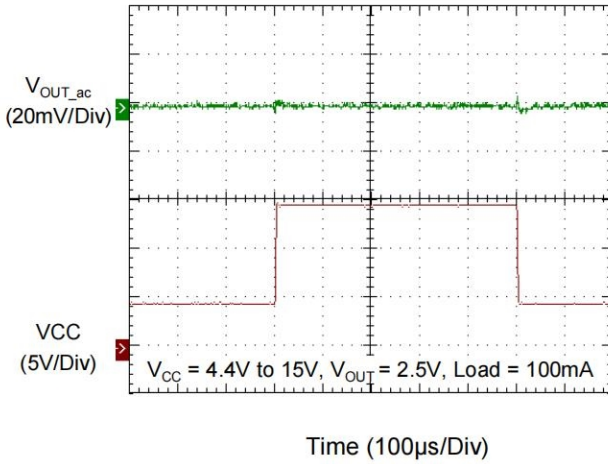

Line Transient Response

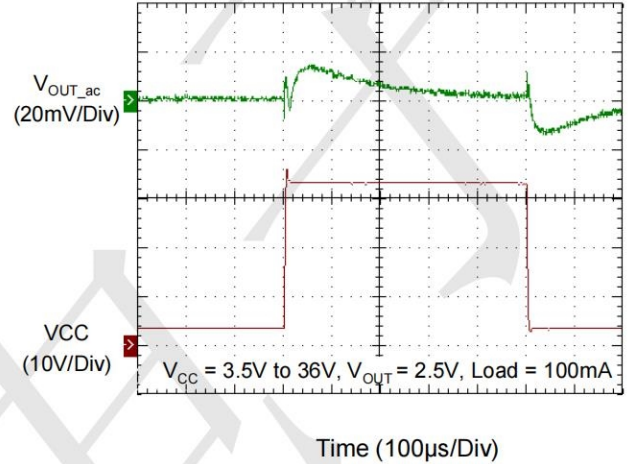

Power On from EN

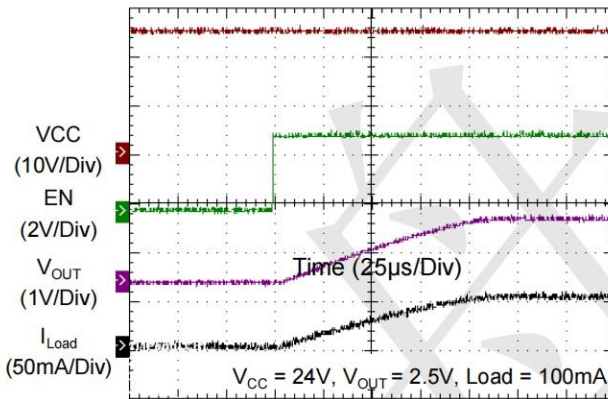

Power Off from EN

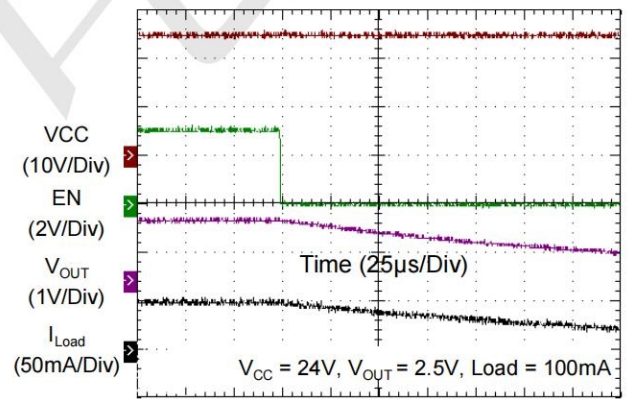



Package informantion

SOT23-5

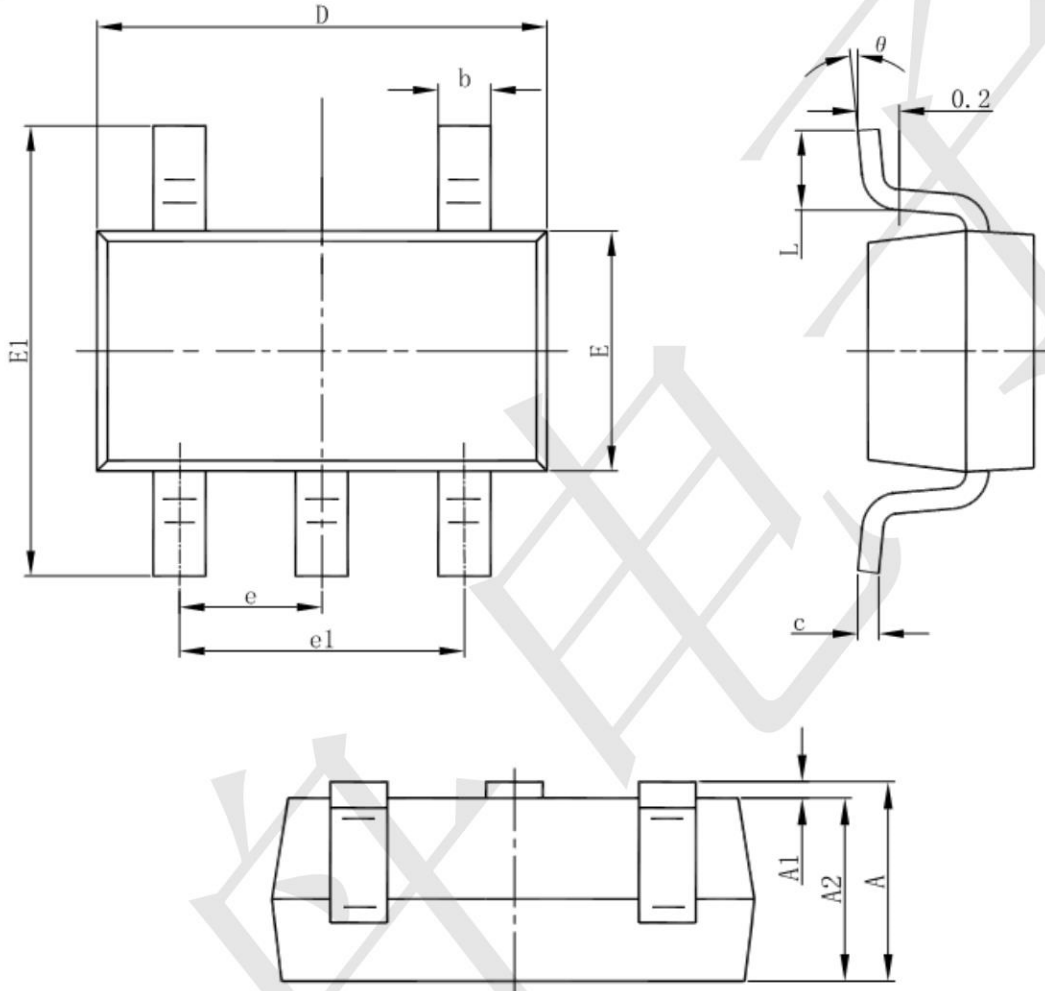

Symbol	Dimensions In Millimeters		Dimensions In Inches	
	Min	Max	Min	Max
A	1.050	1.250	0.041	0.049
A1	0.000	0.100	0.000	0.004
A2	1.050	1.150	0.041	0.045
b	0.300	0.500	0.012	0.020
c	0.100	0.200	0.004	0.008
D	2.820	3.020	0.111	0.119
E	1.500	1.700	0.059	0.067
E1	2.650	2.950	0.104	0.116
e	0.950(BSC)		0.037(BSC)	
e1	1.800	2.000	0.071	0.079
L	0.300	0.600	0.012	0.024
θ	0°	8°	0°	8°