

### Features

- Fast switching
- Green Device Available
- Suit for 1.5V Gate Drive Applications

### Application

- Notebook
- Load Switch
- Networking
- Hand-held Instruments

### Package and Pin Configuration

### Circuit diagram

SOT363



Top View

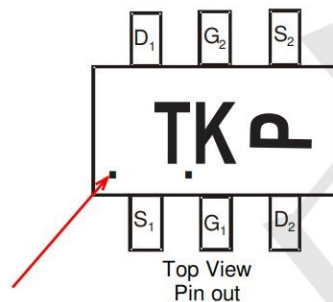

**PIN1**

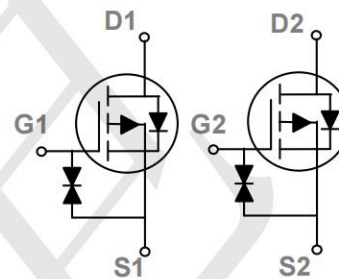

### **Absolute Maximum Ratings** $T_C=25^\circ\text{C}$ unless otherwise noted

Symbol	Parameter	Rating	Units
$V_{DS}$	Drain-Source Voltage	-20	V
$V_{GS}$	Gate-Source Voltage	$\pm 12$	V
$I_D$	Drain Current – Continuous ( $T_C=25^\circ\text{C}$ )	-1.1	A
$I_{DM}$	Drain Current – Pulsed <sup>1</sup>	-2.2	A
$P_D$	Power Dissipation ( $T_C=25^\circ\text{C}$ )	280	mW
	Power Dissipation – Derate above $25^\circ\text{C}$	2.5	mW/ $^\circ\text{C}$
$T_{STG}$	Storage Temperature Range	-55 to 150	$^\circ\text{C}$
$T_J$	Operating Junction Temperature Range	-55 to 150	$^\circ\text{C}$

### **Thermal Characteristics**

Symbol	Parameter	Typ.	Max.	Unit
$R_{\theta JA}$	Thermal Resistance Junction to ambient	---	350	$^\circ\text{C}/\text{W}$

**Electrical Characteristics (T<sub>J</sub>=25 °C, unless otherwise noted)**

Symbol	Parameter	Conditions	Min.	Typ.	Max.	Unit
BV <sub>DSS</sub>	Drain-Source Breakdown Voltage	V <sub>GS</sub> =0V, I <sub>D</sub> =-250uA	-20	---	---	V
ΔBV <sub>DSS</sub> /ΔT <sub>J</sub>	BV <sub>DSS</sub> Temperature Coefficient	Reference to 25°C, I <sub>D</sub> =-1mA	---	-0.01	---	V/°C
I <sub>DSS</sub>	Drain-Source Leakage Current	V <sub>DS</sub> =-20V, V <sub>GS</sub> =0V, T <sub>J</sub> =25°C	---	---	-1	uA
		V <sub>DS</sub> =-16V, V <sub>GS</sub> =0V, T <sub>J</sub> =125°C	---	---	-10	uA
I <sub>GSS</sub>	Gate-Source Leakage Current	V <sub>GS</sub> =±12V, V <sub>DS</sub> =0V	---	---	±20	uA

**On Characteristics**

R <sub>DS(on)</sub>	Static Drain-Source On-Resistance	V <sub>GS</sub> =-4.5V, I <sub>D</sub> =-0.5A	---	400	680	mΩ
		V <sub>GS</sub> =-2.5V, I <sub>D</sub> =-0.5A	---	550		
		V <sub>GS</sub> =-1.8V, I <sub>D</sub> =-0.1A	---	750	1050	
V <sub>GS(th)</sub>	Gate Threshold Voltage	V <sub>GS</sub> =V <sub>DS</sub> , I <sub>D</sub> =-250uA	-0.5	-0.7	1.0	V
ΔV <sub>GS(th)</sub>	V <sub>GS(th)</sub> Temperature Coefficient		---	3	---	mV/°C

**Dynamic and switching Characteristics**

Q <sub>g</sub>	Total Gate Charge <sup>2,3</sup>	V <sub>DS</sub> =-10V, V <sub>GS</sub> =-4.5V, I <sub>D</sub> =-1A	---	0.5	nC
Q <sub>gs</sub>	Gate-Source Charge <sup>2,3</sup>		---	0.28	
Q <sub>gd</sub>	Gate-Drain Charge <sup>2,3</sup>		---	0.28	
T <sub>d(on)</sub>	Turn-On Delay Time <sup>2,3</sup>	V <sub>DD</sub> =-10V, V <sub>GS</sub> =-4.5V, R <sub>G</sub> =6Ω I <sub>D</sub> =-1A	---	0.4	ns
T <sub>r</sub>	Rise Time <sup>2,3</sup>		---	0.06	
T <sub>d(off)</sub>	Turn-Off Delay Time <sup>2,3</sup>		---	0.02	
T <sub>f</sub>	Fall Time <sup>2,3</sup>		---	0.8	
C <sub>iss</sub>	Input Capacitance	V <sub>DS</sub> =-10V, V <sub>GS</sub> =0V, F=1MHz	---	55	pF
C <sub>oss</sub>	Output Capacitance		---	6	
C <sub>riss</sub>	Reverse Transfer Capacitance		---	4.5	

**Drain-Source Diode Characteristics and Maximum Ratings**

Symbol	Parameter	Conditions	Min.	Typ.	Max.	Unit
V <sub>SD</sub>	Diode Forward Voltage	V <sub>GS</sub> =0V, I <sub>S</sub> =-0.2A, T <sub>J</sub> =25°C	---	-0.75	-1.1	V

## Characteristic Curves

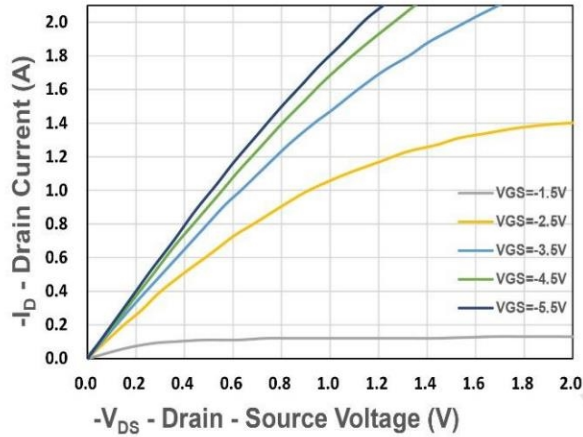

Figure 1. Output Characteristics

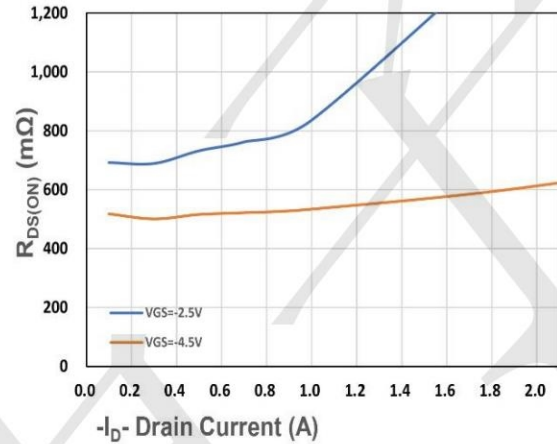

Figure 2. On-Resistance vs.  $I_D$

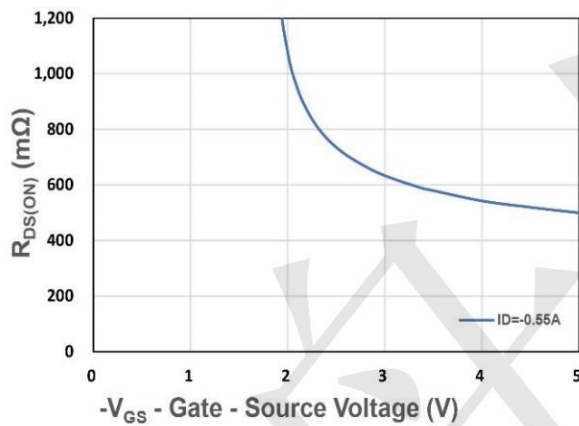

Figure 3. On-Resistance vs.  $V_{GS}$

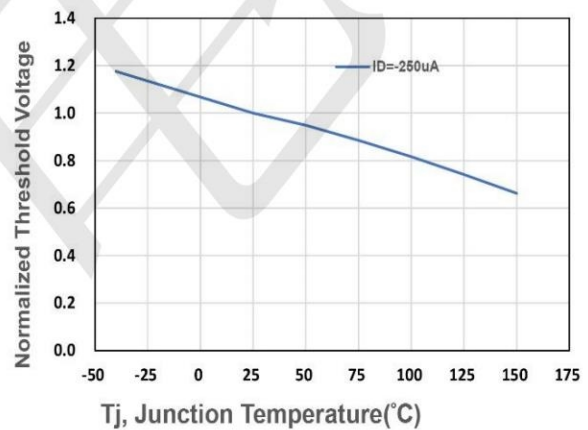

Figure 4. Gate Threshold Voltage

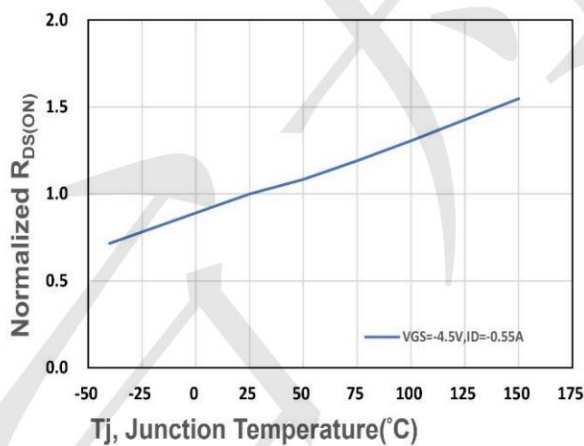

Figure 5. Drain-Source On Resistance

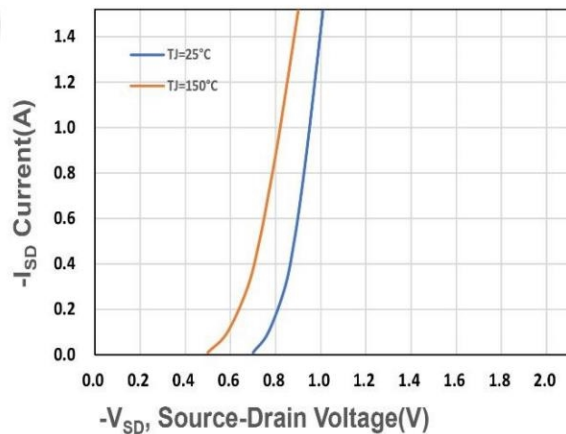

Figure 6. Source-Drain Diode Forward

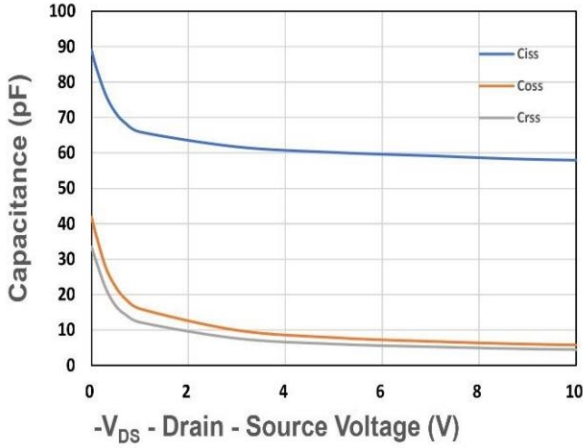

Figure 7. Capacitance

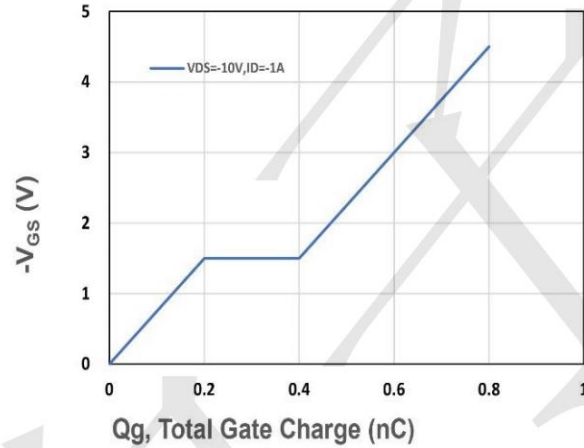

Figure 8. Gate Charge Characteristics

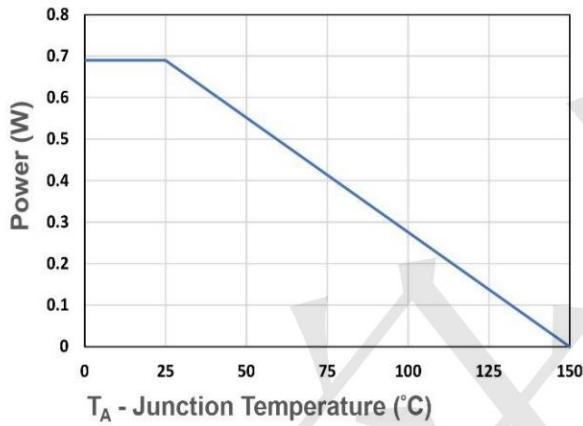

Figure 9. Power Dissipation

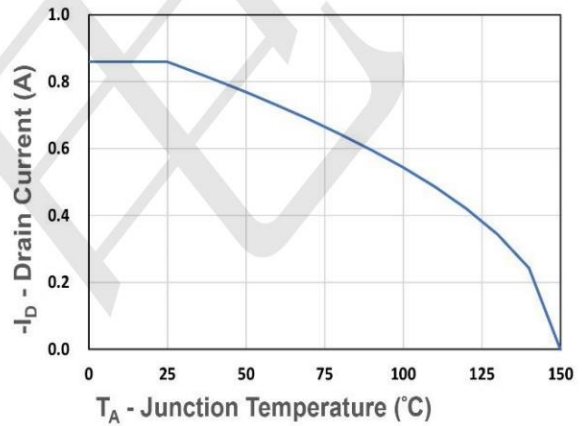

Figure 10. Drain Current

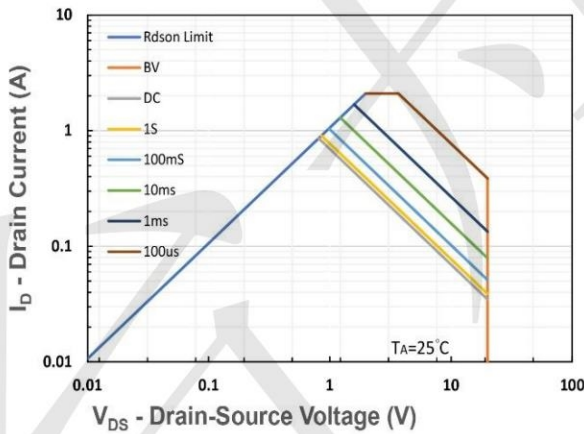

Figure 11. Safe Operating Area

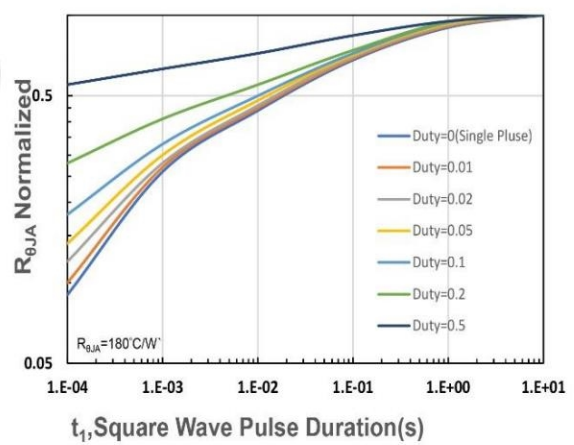
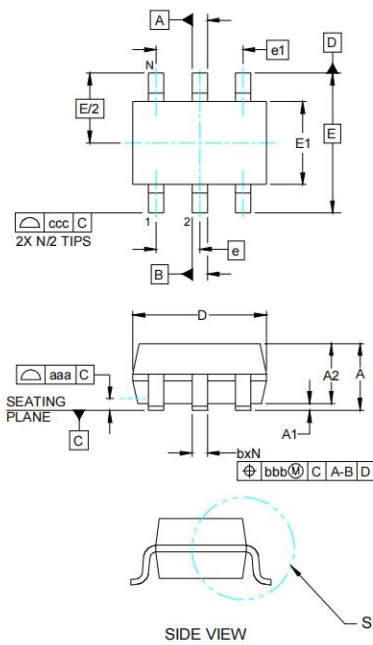

Figure 12.  $R_{\theta JA}$  Transient Thermal Impedance

**Outline Drawing - SOT-363(2.0X2.1)**



DIM	INCHES			MILLIMETERS		
	MIN	NOM	MAX	MIN	NOM	MAX
A	-	-	.043	-	-	1.10
A1	.000	-	.004	0.00	-	0.10
A2	.028	.035	.039	0.70	0.90	1.00
b	.006	-	.012	0.15	-	0.30
c	.003	-	.009	0.08	-	0.22
D	.071	.079	.087	1.80	2.00	2.20
E1	.045	.049	.053	1.15	1.25	1.35
E	.083 BSC			2.10 BSC		
e	.026 BSC			0.65 BSC		
e1	.051			1.30 BSC		
L	.010	.014	.018	0.26	0.36	0.46
L1	(0.17)			(0.42)		
N	6			6		
$\theta 1$	0°	-	8°	0°	-	8°
aaa	.004			0.10		
bbb	.004			0.10		
ccc	.012			0.30		

**Land Pattern - SOT-363**

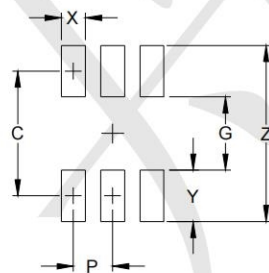

DIM	DIMENSIONS	
	INCHES	MILLIMETERS
C	(.073)	(1.85)
G	.039	1.00
P	.026	0.65
X	.016	0.40
Y	.033	0.85
Z	.106	2.70

**SOT-363 Embossed Carrier Tape**

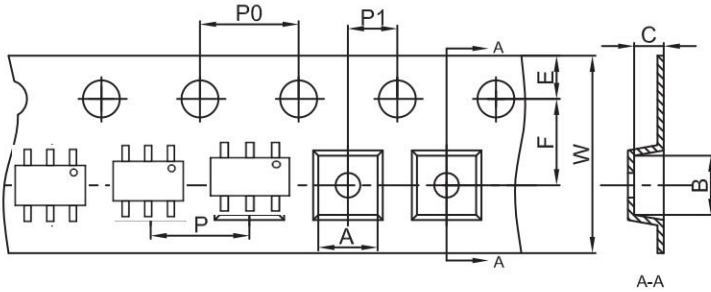

Dimensions are in millimeter										
Pkg type	A	B	C	d	E	F	P0	P	P1	W
SOT-363	2.25	2.55	1.20	Ø1.50	1.75	3.50	4.00	4.00	2.00	8.00

**SOT-363 Tape Leader and Trailer**

Package orientation in reel

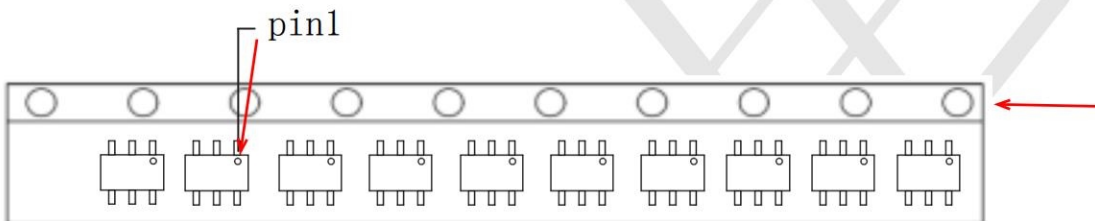

Shipping: 3000 pcs / Tape & Reel

**SOT-363 Reel**

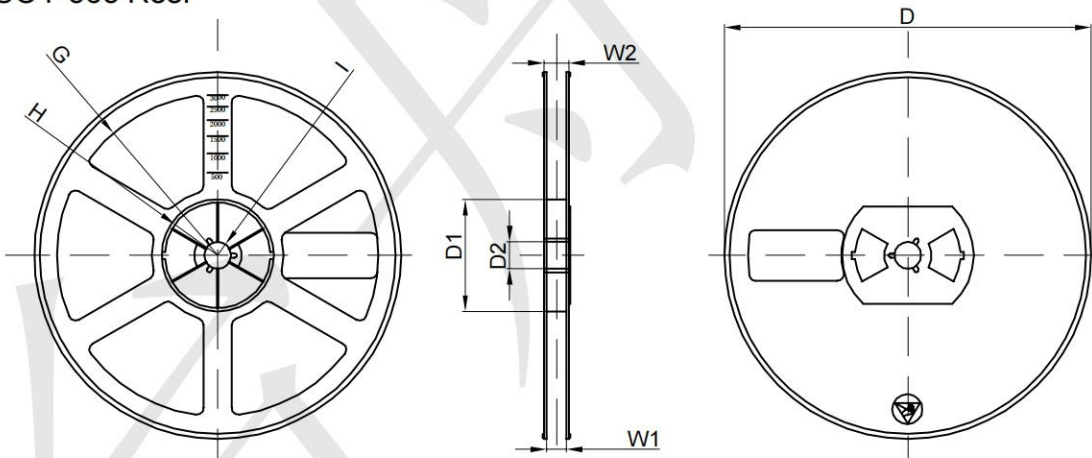

Dimensions are in millimeter								
Reel Option	D	D1	D2	G	H	I	W1	W2
7" Dia	Ø178.00	54.40	13.00	R78.00	R25.60	R6.50	9.50	12.30

REEL	Reel Size	Box	Box Size(mm)	Carton	Carton Size(mm)	G.W.(kg)
3000 pcs	7 Inch	45,000 pcs	203×203×195	180,000 pcs	438×438×220	