

### Features

- Fast switching
- Green Device Available
- Suit for 1.5V Gate Drive Applications

### Application

- Notebook
- Load Switch
- Networking
- Hand-held Instruments

### Package and Pin Configuration

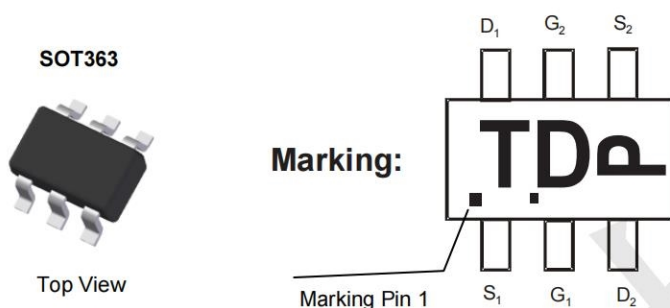

### Circuit diagram

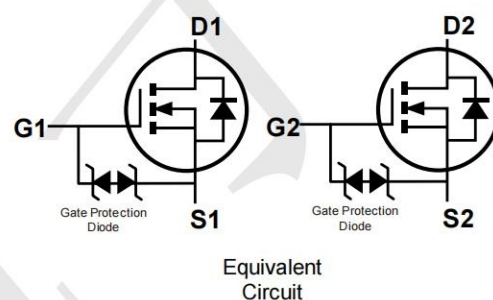

Package orientation in reel

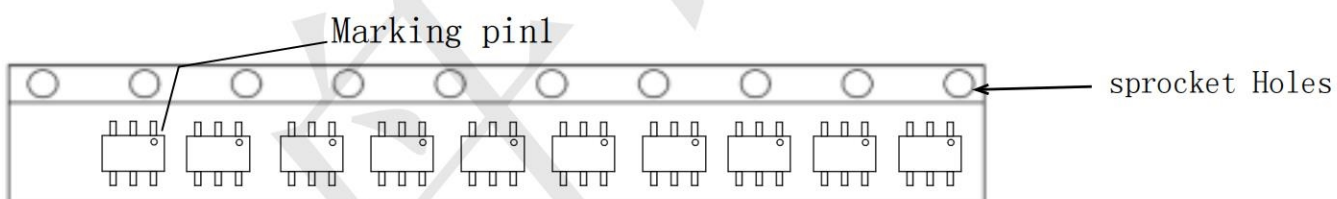

Shipping: 3000pcs / Tape & Reel

### Absolute Maximum Ratings (T<sub>A</sub>=25°C unless otherwise noted)

Parameter	Symbol	Value	Unit
Drain-Source Voltage	V <sub>DS</sub>	20	V
Gate-Source Voltage	V <sub>GS</sub>	±12	V
Continuous Drain Current	I <sub>D</sub>	0.7	A
Pulsed Drain Current (t=300μs) <sup>(1)</sup>	I <sub>DM</sub>	1.8	A
Power Dissipation <sup>(2)</sup>	P <sub>D</sub>	100	mW
Thermal Resistance from Junction to Ambient	R <sub>θJA</sub>	833	°C/W
Junction Temperature	T <sub>J</sub>	150	°C
Storage Temperature	T <sub>STG</sub>	-55~ +150	°C

**Electrical Characteristics (  $T_A = 25^\circ\text{C}$  unless otherwise noted )**

Parameter	Symbol	Test Condition	Min	Type	Max	Unit
<b>Static Characteristics</b>						
Drain-source breakdown voltage	$V_{(BR)DSS}$	$V_{GS} = 0V, I_D = 250\mu A$	20			V
Zero gate voltage drain current	$I_{DSS}$	$V_{DS} = 20V, V_{GS} = 0V$			1	$\mu A$
Gate-body leakage current	$I_{GSS}$	$V_{GS} = \pm 12V, V_{DS} = 0V$			$\pm 10$	$\mu A$
Gate threshold voltage <sup>(3)</sup>	$V_{GS(th)}$	$V_{DS} = V_{GS}, I_D = 250\mu A$	0.5	0.75	1.5	V
Drain-source on-resistance <sup>(3)</sup>	$R_{DS(on)}$	$V_{GS} = 4.5V, I_D = 650mA$		130	330	m $\Omega$
		$V_{GS} = 2.5V, I_D = 550mA$			410	
Forward tranconductance	$g_{FS}$	$V_{DS} = 10V, I_D = 500mA$			1.2	S
<b>Dynamic characteristics<sup>(4)</sup></b>						
Input Capacitance	$C_{iss}$	$V_{DS} = 16V, V_{GS} = 0V, f = 1MHz$			120	pF
Output Capacitance	$C_{oss}$				20	
Reverse Transfer Capacitance	$C_{rss}$				15	
<b>Switching Characteristics<sup>(4)</sup></b>						
Turn-on delay time	$t_{d(on)}$	$V_{DD} = 10V, I_D = 500mA,$ $V_{GS} = 4.5V, R_G = 10\Omega$		6.7		ns
Turn-on rise time	$t_r$			4.8		
Turn-off delay time	$t_{d(off)}$			17.3		
Turn-off fall time	$t_f$			7.4		
<b>Source-Drain Diode characteristics</b>						
Diode Forward voltage <sup>(3)</sup>	$V_{DS}$	$I_S = 0.15A, V_{GS} = 0V$			1.2	V

**Outline Drawing - SOT-363(2.0X2.1)**

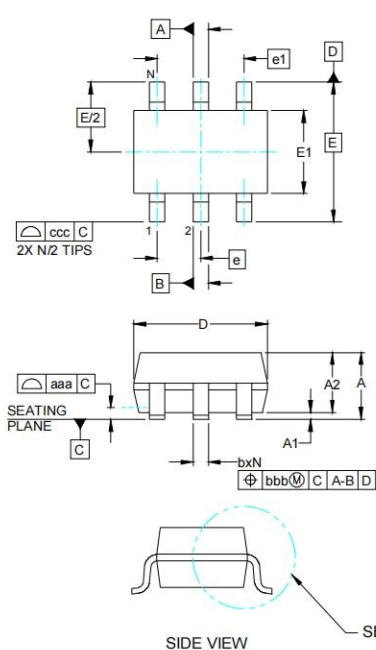

DIM	INCHES			MILLIMETERS		
	MIN	NOM	MAX	MIN	NOM	MAX
A	-	-	.043	-	-	1.10
A1	.000	-	.004	0.00	-	0.10
A2	.028	.035	.039	0.70	0.90	1.00
b	.006	-	.012	0.15	-	0.30
c	.003	-	.009	0.08	-	0.22
D	.071	.079	.087	1.80	2.00	2.20
E1	.045	.049	.053	1.15	1.25	1.35
E	.083 BSC			2.10 BSC		
e	.026 BSC			0.65 BSC		
e1	.051			1.30 BSC		
L	.010	.014	.018	0.26	0.36	0.46
L1	(0.017)			(0.42)		
N	6			6		
θ1	0°	-	8°	0°	-	8°
aaa	.004			0.10		
bbb	.004			0.10		
ccc	.012			0.30		

**Land Pattern - SOT-363**

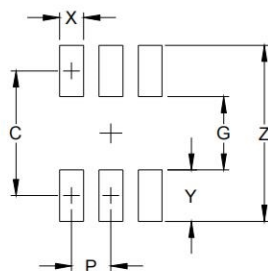

DIM	DIMENSIONS	
	INCHES	MILLIMETERS
C	(.073)	(1.85)
G	.039	1.00
P	.026	0.65
X	.016	0.40
Y	.033	0.85
Z	.106	2.70

SOT-363 Embossed Carrier Tape

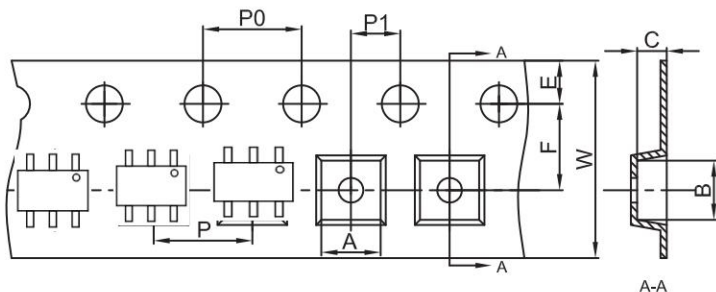

Dimensions are in millimeter										
Pkg type	A	B	C	d	E	F	P0	P	P1	W
SOT-363	2.25	2.55	1.20	Ø1.50	1.75	3.50	4.00	4.00	2.00	8.00

SOT-363 Tape Leader and Trailer

Package orientation in reel

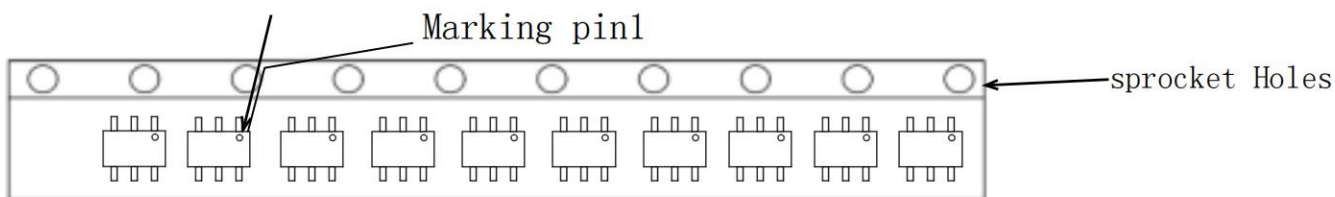

Shipping: 3000 pcs / Tape & Reel

SOT-363 Reel

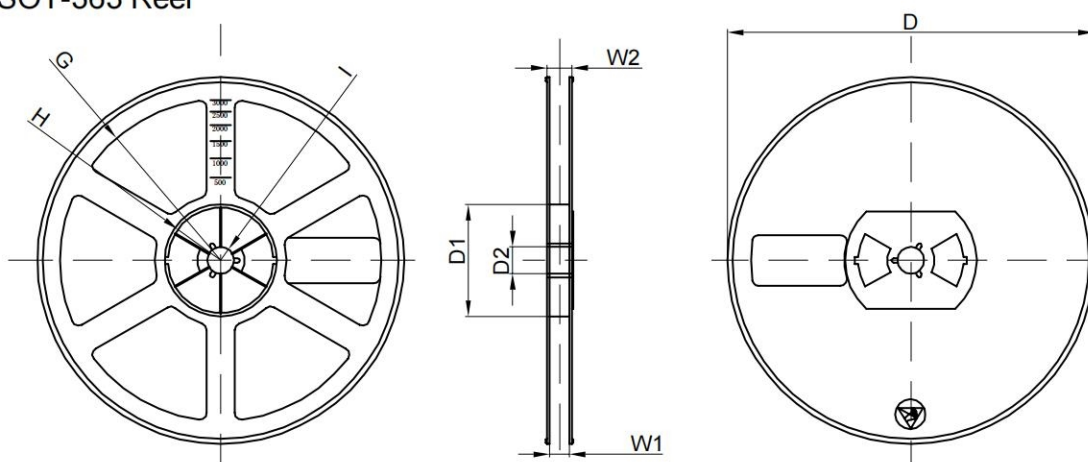

Dimensions are in millimeter								
Reel Option	D	D1	D2	G	H	I	W1	W2
7" Dia	Ø178.00	54.40	13.00	R78.00	R25.60	R6.50	9.50	12.30

REEL	Reel Size	Box	Box Size(mm)	Carton	Carton Size(mm)	G.W.(kg)
3000 pcs	7 inch	45,000 pcs	203×203×195	180,000 pcs	438×438×220	