

DUAL LOW POWER CMOS OPERATIONAL AMPLIFIER

DESCRIPTION

The HT2336A is a dual low power CMOS operational amplifiers IC which provides high performance operation at low supply voltages. The basic amplifier can operate at supply voltage as low as 1.4V with very low power consumption and makes it perfect for battery-powered application. The input common-mode voltage extends to the negative rail. The output swings to both rails with light load. The input bias current is inherently low and the input impedance is extremely high. The devices are ideal upgrades for industrial standards operational amplifiers.

FEATURES

- Low Power Replacement for Standard OP Amps
- Wide supply operating range (1.4V to 7V)
- Input common-mode voltage range includes negative rail
- Output swing to rail
- Low input bias current (typical 1pA)
- High input impedance
- Single supply operation
- Internal compensated
- Output short circuit protection

APPLICATIONS

- Portable Instruments
- Battery-Powered Systems
- Transducer Interfacing
- Active Filter
- High Impedance Buffer

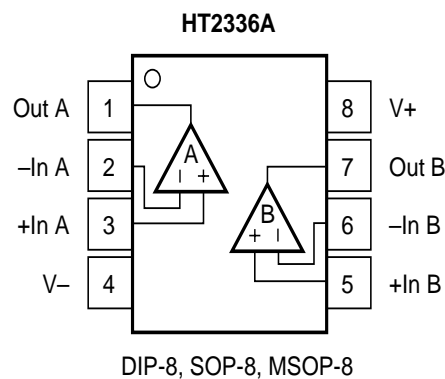

ABSOLUTE MAXIMUM RATINGS

Characteristic	Symbol	Value	Unit
Power Supply Voltage	V_{CC}	8.5	V
Input Voltage	V_{IN}	-0.3 to $V_{CC} + 0.3$	V
Output Shot Circuit to GND	I_{SC}	Continuous	
Operating Temperature Range	T_{opr}	0 ~ +70	°C
Storage Temperature Range	T_{stg}	-65 ~ +150	°C

ELECTRICAL CHARACTERISTICS ($V_{CC} = 3.0V$, $T_A = 25^\circ C$, unless otherwise specified)

Characteristic	Symbol	Test Condition	Min	Typ	Max	Unit
Input Offset Voltage	V_{IO}	$V_{ICM}=0V$ to $V_{CC}-1.5V$		0.5	1.0	mV
Input Offset Voltage Drift	$\Delta V_{IO}/\Delta T$			0.7		$\mu V/^\circ C$
Input Offset Current	I_{IO}			1		ρA
Input Bias Current	I_{IB}			1		ρA
Input Common Mode Voltage Range	V_{ICR}		0		$V_{CC}-1.3$	V
Supply Current (per amplifier)	I_{CC}			5	9	μA
Large Signal Voltage Gain	A_V	$V_O=1V$ to $2V$; $V_{IN}=1.4V$; $R_L=1M\Omega$	20	100		V/mV
Output Voltage Swing	V_{OH}	$V_{IN}=10mV$; $R_L=1M\Omega$ (to V-)	2.95	2.99		V
		$V_{IN}=10mV$; $R_L=10K\Omega$ (to V-)		2.6		
		$V_{IN}=10mV$; $R_L=1M\Omega$ (to V+)		0.2	0.5	
Common Mode Rejection Ratio	CMRR	$V_O=1V$; $V_{IN}=0V$ to $2.0V$;	60	80		dB
Output Current	I_{source}		1.5	2.5		mA
	I_{sink}		3	5		μA
Differential Input Voltage	V_{ID}				V_{CC}	V

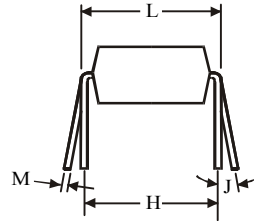
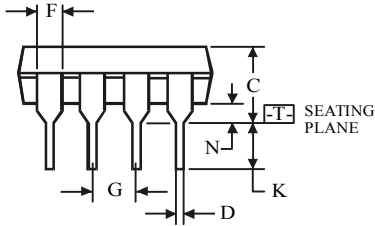
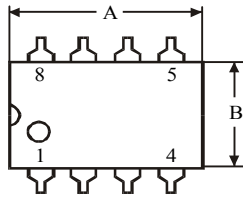
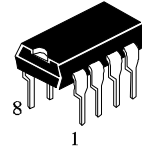
(DIP8)

$$\text{⌀} 0.25 (0.010) \text{Ⓜ} \text{T}$$

Symbol	Dimension, mm	
	MIN	MAX
A	8.51	10.16
B	6.1	7.11
C		5.33
D	0.36	0.56
F	1.14	1.78
G	2.54	
H	7.62	
J	0°	10°
K	2.92	3.81
L	7.62	8.26
M	0.2	0.36
N	0.38	

NOTES:

- Dimensions "A", "B" do not include mold flash or protrusions.
Maximum mold flash or protrusions 0.25 mm (0.010) per side.

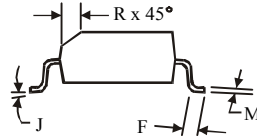
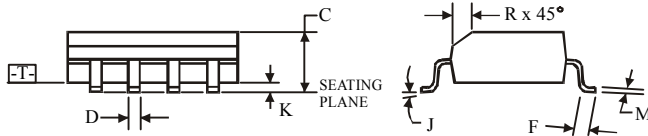
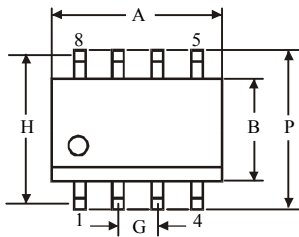
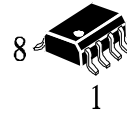
(SOP8)

$$\text{⌀} 0.25 (0.010) \text{Ⓜ} \text{T} \text{Ⓜ}$$

Symbol	Dimension, mm	
	MIN	MAX
A	4.8	5
B	3.8	4
C	1.35	1.75
D	0.33	0.51
F	0.4	1.27
G	1.27	
H	5.72	
J	0°	8°
K	0.1	0.25
M	0.19	0.25
P	5.8	6.2
R	0.25	0.5

NOTES:

- Dimensions A and B do not include mold flash or protrusion.
- Maximum mold flash or protrusion 0.15 mm (0.006) per side for A; for B - 0.25 mm (0.010) per side.