

Four low power CMOS operational amplifiers

DESCRIPTION

The HT2274A is a quad low power CMOS operational amplifiers IC which provides high performance operation at low supply voltages. The basic amplifier can operate at supply voltage as low as 1.4V with very low power consumption and makes it perfect for battery-powered application. The input common-mode voltage extends to the negative rail. The output swings to both rails with light load. The input bias current is inherently low and the input impedance is extremely high. The devices are ideal upgrades for industrial standards operational amplifiers.

FEATURES

- Low Power Replacement for Standard OP Amps
- Wide supply operating range (1.4V to 7V)
- Input common-mode voltage range includes negative rail
- Output swing to rail
- Low input bias current (typical 1pA)
- High input impedance
- Single supply operation
- Internal compensated
- Output short circuit protection

APPLICATIONS

- Portable Instruments
- Battery-Powered Systems
- Transducer Interfacing
- Active Filter
- High Impedance Buffer

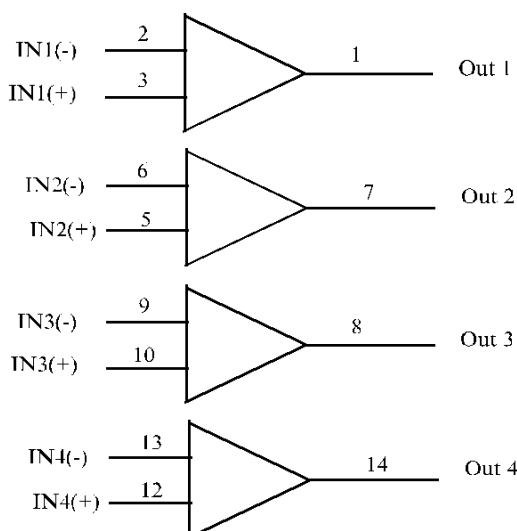
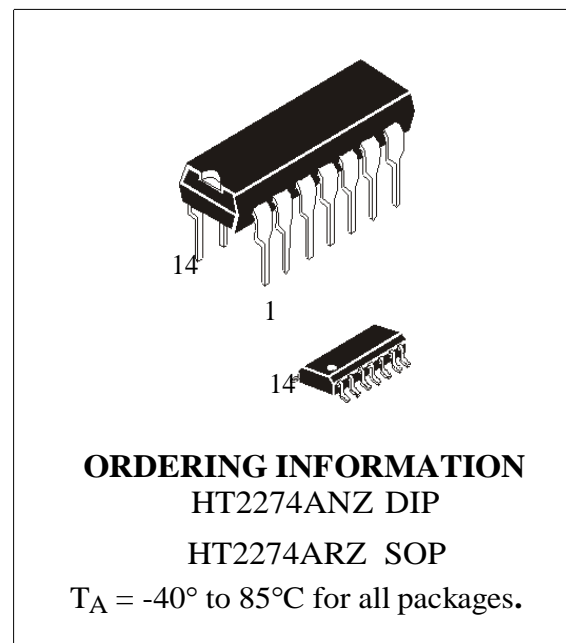

PIN 4 = V_{CC}
 PIN 11 = GND

PIN ASSIGNMENT

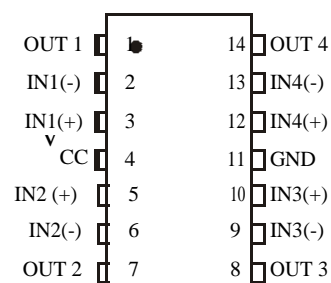

ABSOLUTE MAXIMUM RATINGS

Characteristic	Symbol	Value	Unit
Power Supply Voltage	V_{CC}	8	V
Input and Output Voltage	V_{IN}, V_{OUT}	$V+ -0.3$ to $V- +0.3$	V
Storage Temperature Range	T_{stg}	-65 ~ +150	°C
Ambient Temperature	T_A	-20 ~ 100	°C
Duration of output short circuit		Unlimited	

NOTE: Stresses above those listed may cause permanent damage to the devices.

ELECTRICAL CHARACTERISTICS ($V+ = 5V, V- = 0V, T_A = 25^\circ C$, unless otherwise specified)

Characteristic	Symbol	Test Condition	Min	Typ	Max	Unit
Input Offset Voltage	V_{IO}			1	3	mV
Input Offset Voltage Drift	$\Delta V_{IO}/\Delta T$			0.7		$\mu V/^\circ C$
Input Offset Current	I_{IO}			1		ρA
Input Bias Current	I_{IB}	$T_A = 25^\circ C$		1		ρA
Input Common Mode Voltage Range	V_{ICR}		0		$V_{CC}-1.3$	V
Supply Current (per amplifier)	I_{CC}			5	9	μA
Large Signal Voltage Gain	A_v	$V_O=1V$ to $4V; V_{IN}=1.4V; R_L=1M\Omega$	20	100		V/mV
Output Voltage Swing	V_{OH}	$V_{IN}=10mV; R_L=1M\Omega$ (to $V-$)	4.9	4.99		V
		$V_{IN}=10mV; R_L=100K\Omega$ (to $V-$)		4.95		
		$V_{IN}=10mV; R_L=10K\Omega$ (to $V-$)		4.75		
	V_{OL}	$V_{IN}=-10mV; R_L=1M\Omega$ (to $V+$)		0.5	0.7	
		$V_{IN}=-10mV; R_L=100K\Omega$ (to $V+$)		0.65		
Common Mode Rejection Ratio	CMRR	$V_O=1V; V_{IN}=0V$ to $3.5V$;	60	80		dB
Power Supply Rejection Ratio	PSRR	$V_O=1V$	60	90		dB

TYPICAL APPLICATION CIRCUIT

• **VOLTAGE FOLLOWER**

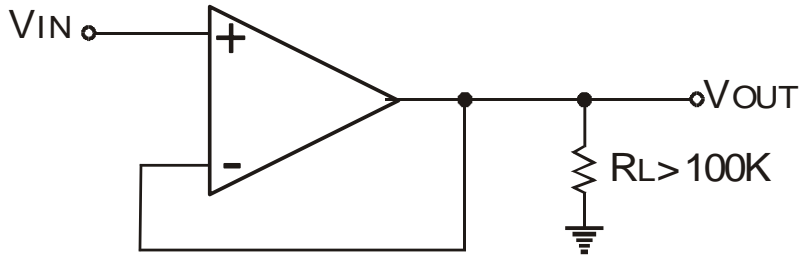

• **INSTRUMENT AMPLIFIER**

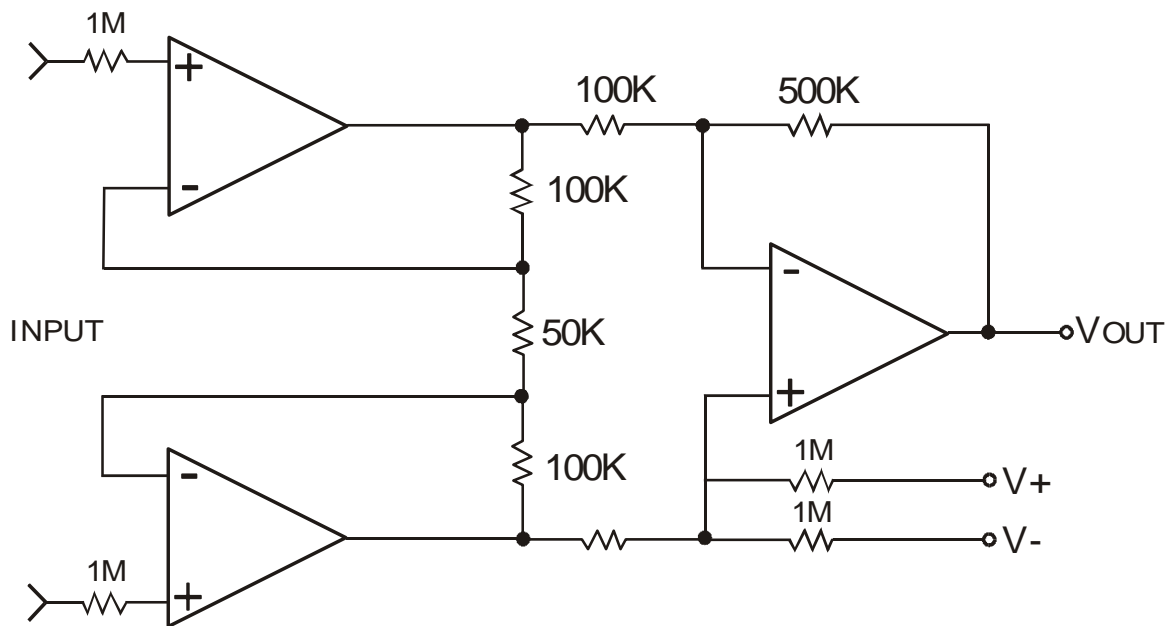

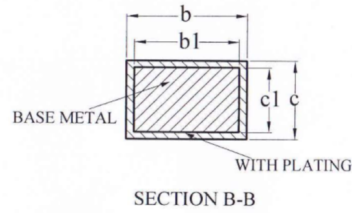
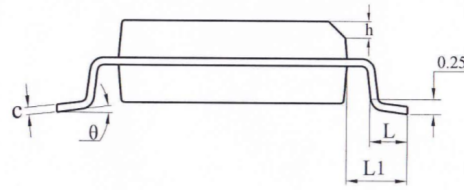
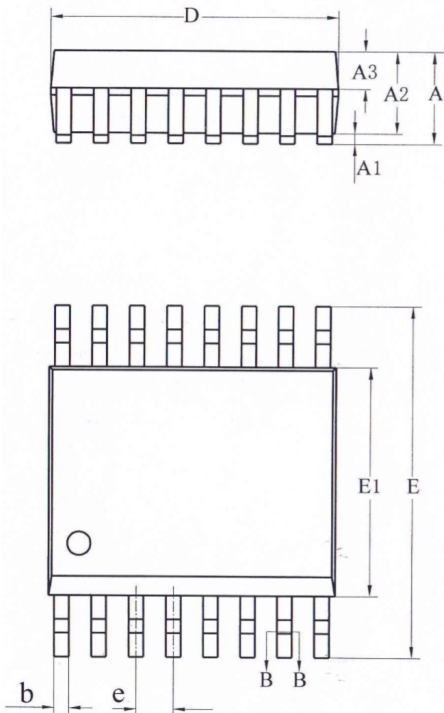
SSOP14

SYMBOL	MILLIMETER		
	MIN	NOM	MAX
A	—	—	1.75
A1	0.10	—	0.225
A2	1.30	1.40	1.50
A3	0.55	0.60	0.65
b	0.23	—	0.31
b1	0.22	0.25	0.28
c	0.20	—	0.24
c1	0.19	0.20	0.21
D	4.80	4.90	5.00
E	5.80	6.00	6.20
E1	3.80	3.90	4.00
e	0.635BSC		
h	0.25	—	0.50
L	0.50	0.65	0.80
L1	1.05REF		
θ	0	—	8°

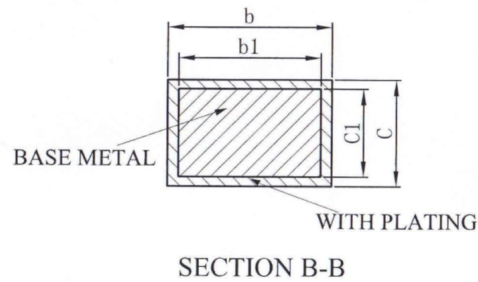
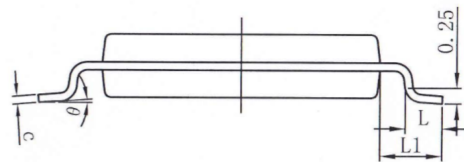
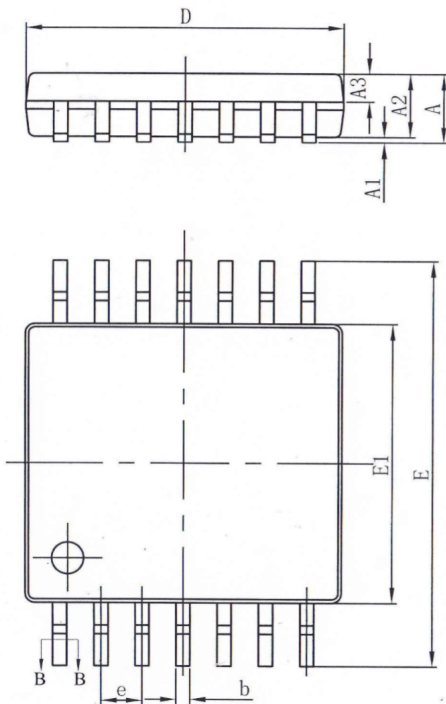
TSSOP14

SYMBOL	MILLIMETER		
	MIN	NOM	MAX
A	—	—	1.20
A1	0.05	—	0.15
A2	0.90	1.00	1.05
A3	0.39	0.44	0.49
b	0.20	—	0.28
b1	0.19	0.22	0.25
c	0.13	—	0.17
c1	0.12	0.13	0.14
D	4.90	5.00	5.10
E1	4.30	4.40	4.50
E	6.20	6.40	6.60
e	0.65BSC		
L	0.45	0.60	0.75
L1	1.00BSC		
θ	0	—	8°

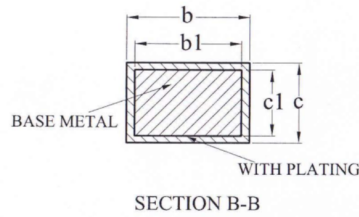
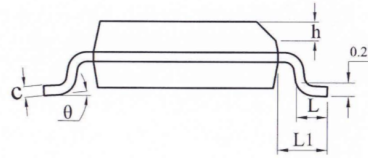
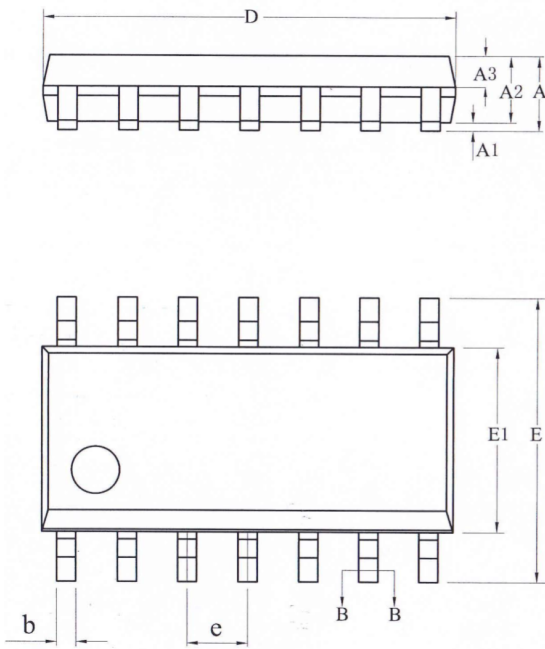
SOP14

SYMBOL	MILLIMETER		
	MIN	NOM	MAX
A	—	—	1.75
A1	0.05	—	0.225
A2	1.30	1.40	1.50
A3	0.60	0.65	0.70
b	0.39	—	0.47
b1	0.38	0.41	0.44
c	0.20	—	0.24
c1	0.19	0.20	0.21
D	8.55	8.65	8.75
E	5.80	6.00	6.20
E1	3.80	3.90	4.00
e	1.27BSC		
h	0.25	—	0.50
L	0.50	—	0.80
L1	1.05REF		
θ	0	—	8°

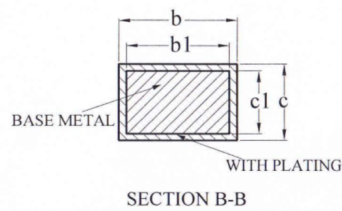
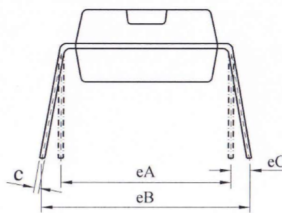
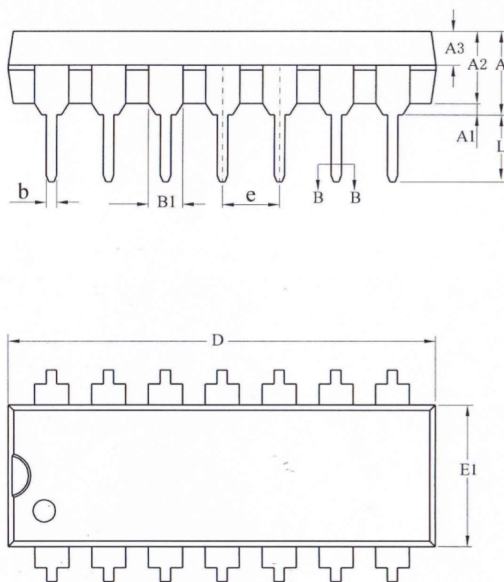
DIP14

SYMBOL	MILLIMETER		
	MIN	NOM	MAX
A	3.60	3.80	4.00
A1	0.51	—	—
A2	3.20	3.30	3.40
A3	1.47	1.52	1.57
b	0.44	—	0.52
b1	0.43	0.46	0.49
B1	1.52REF		
c	0.25	—	0.29
c1	0.24	0.25	0.26
D	19.00	19.10	19.20
E1	6.25	6.35	6.45
e	2.54BSC		
eA	7.62REF		
eB	7.62	—	9.30
eC	0	—	0.84
L	3.00	—	—