



## Plastic-Encapsulate Transistors

TRANSISTOR (PNP)

### FEATURES

- Compliment to 2N3904U
- Low current
- Low voltage

### MARKING: 2A

### MAXIMUM RATINGS (T<sub>a</sub>=25°C unless otherwise noted)

Symbol	Parameter	Value	Units
V <sub>CB0</sub>	Collector-Base Voltage	-40	V
V <sub>CEO</sub>	Collector-Emitter Voltage	-40	V
V <sub>EBO</sub>	Emitter-Base Voltage	-6	V
I <sub>C</sub>	Collector Current -Continuous	-0.2	A
P <sub>C</sub>	Collector Power Dissipation	0.5	W
R <sub>θJA</sub>	Thermal resistance from junction to ambient	250	°C/W
T <sub>J</sub>	Junction Temperature	150	°C
T <sub>stg</sub>	Storage Temperature	-55-150	°C

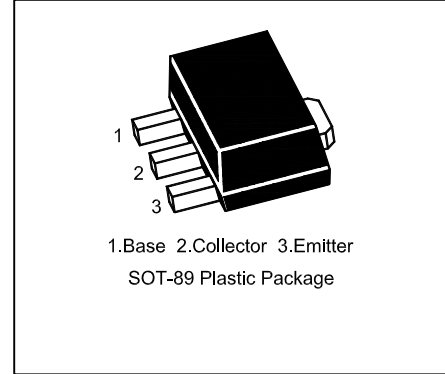

### ELECTRICAL CHARACTERISTICS (T<sub>a</sub>=25°C unless otherwise specified)

Parameter	Symbol	Test conditions	Min	Typ	Max	Unit
Collector-base breakdown voltage	V <sub>(BR)CBO</sub>	I <sub>C</sub> =-10μA, I <sub>E</sub> =0	-40			V
Collector-emitter breakdown voltage	V <sub>(BR)CEO</sub>	I <sub>C</sub> =-1mA, I <sub>B</sub> =0	-40			V
Emitter-base breakdown voltage	V <sub>(BR)EBO</sub>	I <sub>E</sub> =-10μA, I <sub>C</sub> =0	-6			V
Collector cut-off current	I <sub>CBO</sub>	V <sub>CB</sub> =-30V, I <sub>E</sub> =0			-0.05	μA
Emitter cut-off current	I <sub>EBO</sub>	V <sub>EB</sub> =-6V, I <sub>C</sub> =0			-0.05	μA
Collector ut-off current	I <sub>CEX</sub>	V <sub>CB</sub> =-30V, V <sub>BE(off)</sub> =-3V			-0.05	μA
DC current gain	h <sub>FE(1)</sub>	V <sub>CE</sub> =-1V, I <sub>C</sub> =-0.1mA	60			
	h <sub>FE(2)</sub>	V <sub>CE</sub> =-1V, I <sub>C</sub> =-1mA	80			
	h <sub>FE(3)</sub>	V <sub>CE</sub> =-1V, I <sub>C</sub> =-10mA	100		300	
	h <sub>FE(4)</sub>	V <sub>CE</sub> =-1V, I <sub>C</sub> =-50mA	60			
	h <sub>FE(5)</sub>	V <sub>CE</sub> =-1V, I <sub>C</sub> =-100mA	30			
Collector-emitter saturation voltage	V <sub>CE(sat)1</sub>	I <sub>C</sub> =-10mA, I <sub>B</sub> =-1mA			-0.25	V
	V <sub>CE(sat)2</sub>	I <sub>C</sub> =-50mA, I <sub>B</sub> =-5mA			-0.4	V
Base-emitter saturation voltage	V <sub>BE(sat)1</sub>	I <sub>C</sub> =-10mA, I <sub>B</sub> =-1mA	-0.65		-0.85	V
	V <sub>BE(sat)2</sub>	I <sub>C</sub> =-50mA, I <sub>B</sub> =-5mA			-0.95	V
Transition frequency	f <sub>T</sub>	V <sub>CE</sub> =-20V, I <sub>C</sub> =-10mA, f=100MHz	250			MHz
Collector capacitance	C <sub>c</sub>	V <sub>CB</sub> =-5V, I <sub>E</sub> =0, f=1MHz			4.5	pF
Emitter capacitance	C <sub>e</sub>	V <sub>EB</sub> =-0.5V, I <sub>C</sub> =0, f=1MHz			10	pF
Noise figure	NF	V <sub>CE</sub> =-5V, I <sub>C</sub> =-0.1mA, f=10Hz-15.7kHz, R <sub>S</sub> =1KΩ			4	dB
Delay time	t <sub>d</sub>	I <sub>C</sub> =-10mA, I <sub>B1</sub> =-I <sub>B2</sub> =-1mA			35	nS
Rise time	t <sub>r</sub>				35	nS
Storage time	t <sub>S</sub>				225	nS
Fall time	t <sub>f</sub>				75	nS

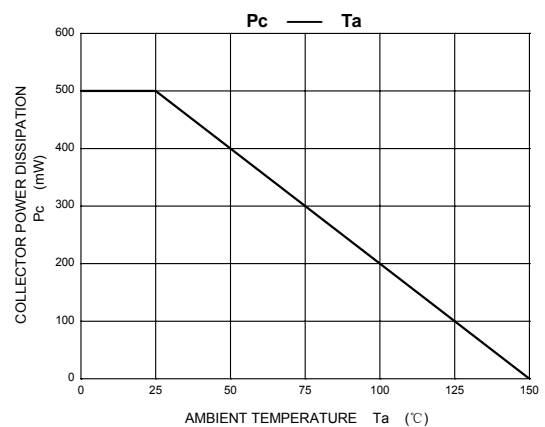
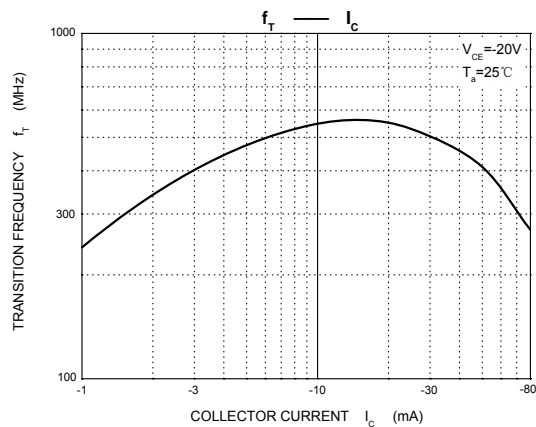
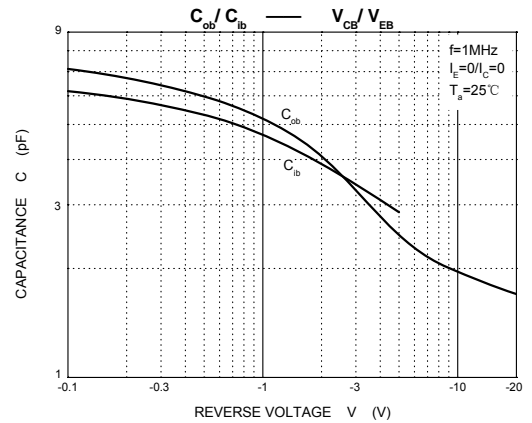
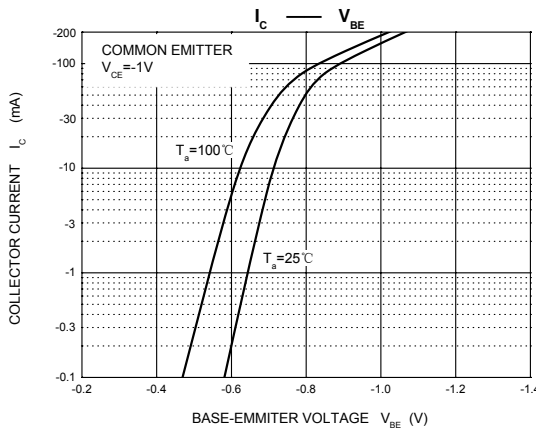
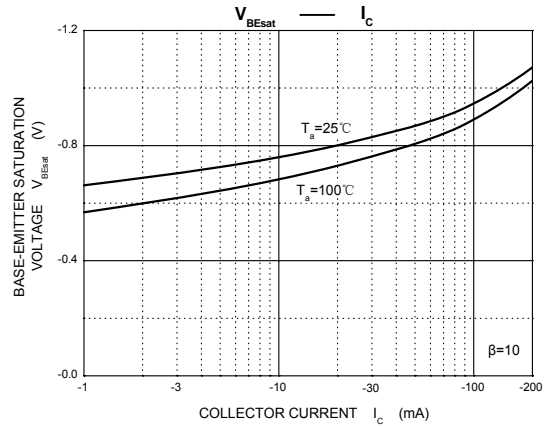
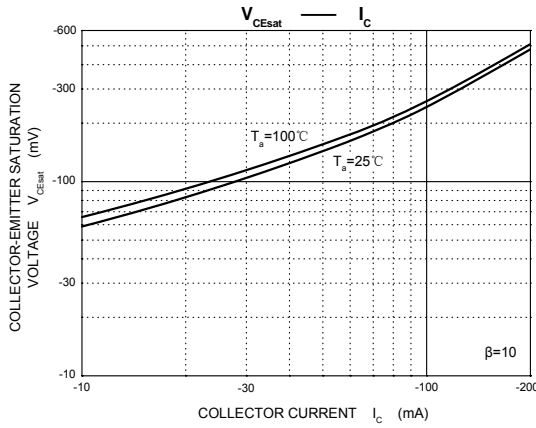
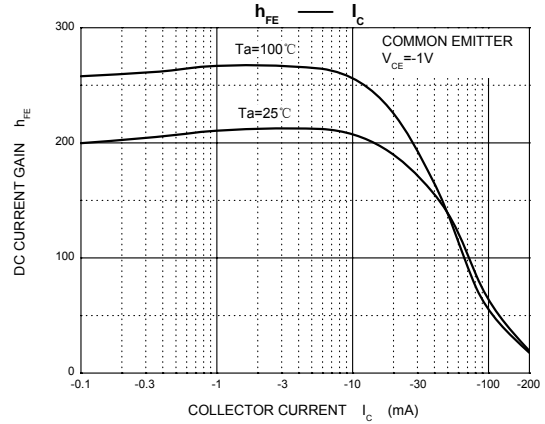
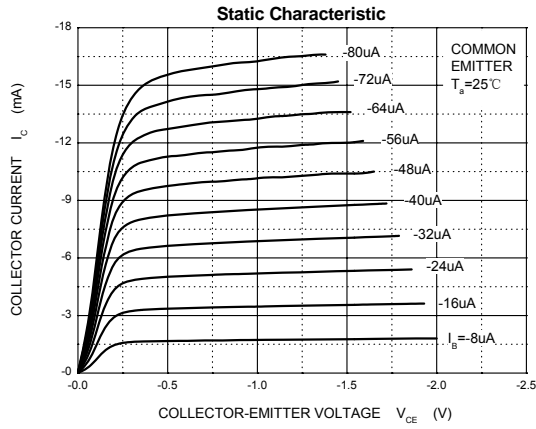



**CHINA BASE**  
INTERNATIONAL

# SOT-89

## 2N3906U



www.china-base.com.hk

### SOT-89 PACKAGE OUTLINE

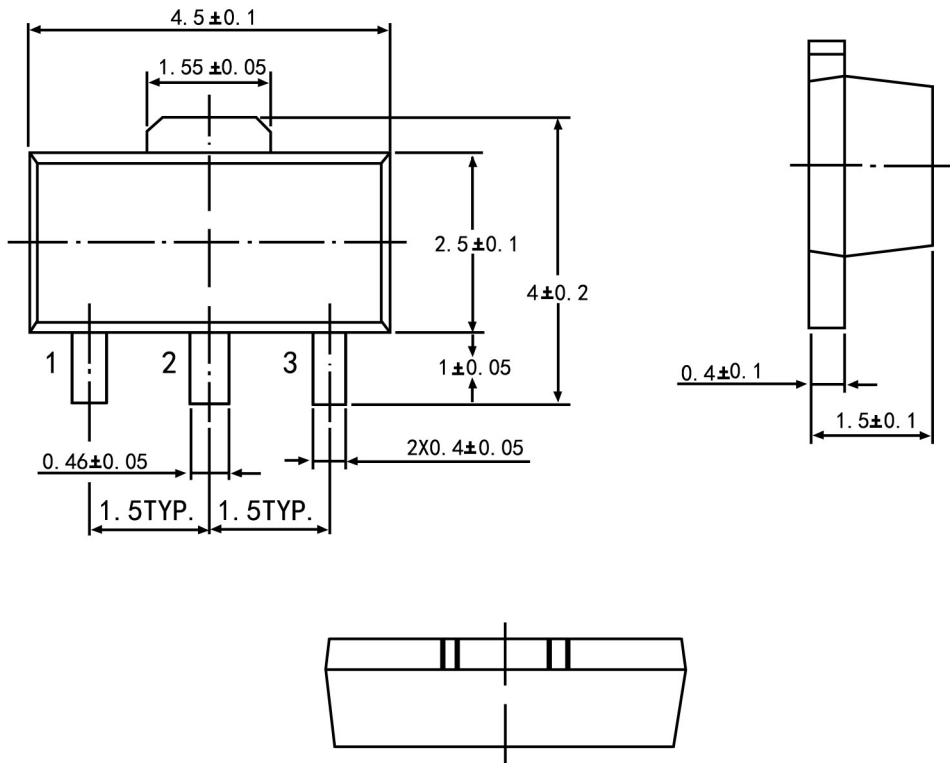

Symbol	Dimension in Millimeters	
	Min	Max
A	1.40	1.60
B	0.44	0.62
B1	0.35	0.54
C	0.35	0.44
D	4.40	4.60
D1	1.62	1.83
E	2.29	2.60
e	1.50 Typ	
H	3.94	4.25
H1	2.63	2.93
L	0.89	1.20
All Dimensions In mm		