



<b>Customer</b>	
<b>Production Name</b>	<b>SMD CRYSTAL SEAM 3.2*2.5</b>
<b>Customer P/N</b>	<b>N/A</b>
<b>TROQ P/N</b>	<b>RL240001653</b>
<b>Revision</b>	<b>A</b>
<b>Print Date</b>	<b>2021-8-17</b>

<b>Drawn</b>	<b>Checked</b>	<b>Approved</b>
		

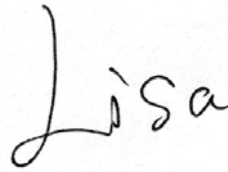

**RoHS Compliant**

Pb used in sealing glass material is exempt from EU directive

● ELECTRICAL PARAMETERS

谐振器产品技术指标	Min	Max	Units
1. Holder Type(型号规格)	SEAM 3.2*2.5		
2. Mode of Oscillation (振动模式)	AT-Fundamental		
3. Frequency (标称频率)	24.000000		MHz
4. Load Capacitance (CL) (负载电容)	20		pF
5. Shunt Capacitance (Co) (静态电容)	0	5	pF
6. Equivalent Resistance (谐振电阻)	40		$\Omega$
7. Frequency Tolerance at 25°C (调整频差)	-5	5	ppm
8. Stability over operation temperance (温度频差)	$\pm 10$		ppm
9. Insulation Resistance (at DC 100V) (绝缘电阻)	500		M $\Omega$
10. Drive Level (激励功率)	100		uw
11. Operating Temperature Range (工作温度范围)	-20	70	$^{\circ}\text{C}$
12. Storage Temperature Range (储存温度范围)	-40	85	$^{\circ}\text{C}$
13. Aging (老化率)	$\pm 3$		ppm/year
14. Other(其他)	0		

OUTLINE DIMENSIONS(UNIT:mm) 外形尺寸 (单位: mm)

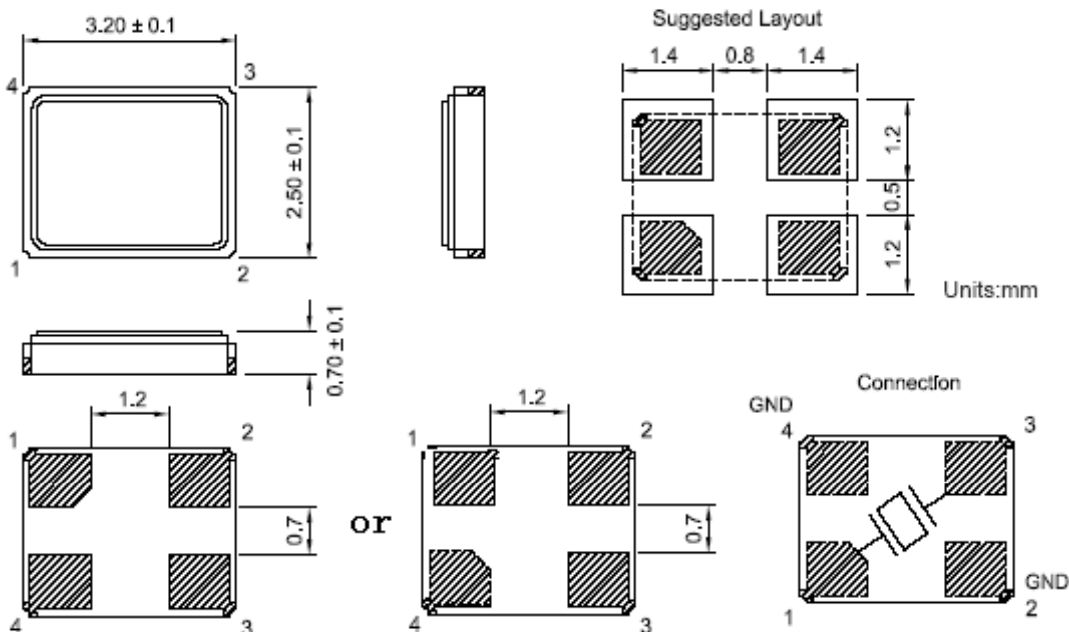

● Marking (标记)

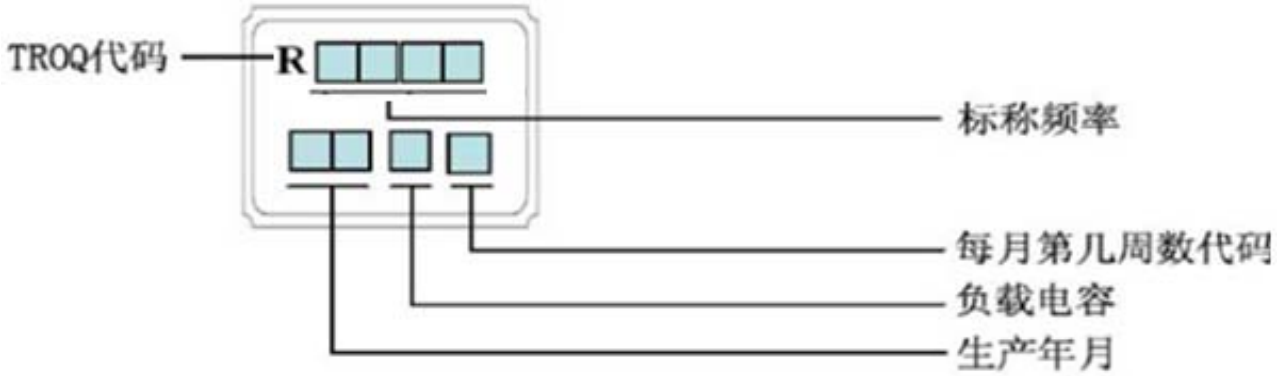

● 负载电容

负载电容 (CL)	5.7	10	12	12.5	15	16	18
代码	A	B	C	D	E	F	G
负载电容 (CL)	20	22	27	30	32	∞	8
代码	H	J	K	M	N	S	R
负载电容 (CL)	7	9	13	7.5			其他
代码	T	V	W	X	Y	Z	P

● 生产年月 (年份为12年一循环)

月份	1	2	3	4	5	6	7	8	9	10	11	12
代码	A	B	C	D	E	F	G	H	K	M	N	P

年份	2020	2021	2022	2023	2024	2025	2026	2027	2028	2029	2030	2031
代码	a	b	c	d	e	f	g	h	k	m	n	p



说明: 标称频率 25.000MHZ  
负载电容20PF  
2020年1月份第一周 TROQ制造:

● SUGGESTED REFLOW PROFILE (回流焊曲线图)

Total time:200sec.Max. (总时间: 200秒 最大)

Solder melting point:220°C (熔点220 °C)

Profiles Feature (特性)		Pb-Free Assembly
Average Ramp-up Rate(Ts max to Tp)	平均升温速度	3°C/second Max
Preheat	预热	
■ Temperature Min (Ts min)	最低温度	125°C
■ Temperature Max (Ts max)	最高温度	200°C
■ Time (ts min to ts max)	从最低到最高时间	(60~180) seconds
Time maintained above	维持上述时间	
■ Temperature(T1)	温度	217°C
■ Time(tp)	时间	(60~150) seconds
Peak/Classification Temperature(Tp)	最高点温度	260 °C
Time within 5°C of actual Peak Temperature(tp)	高温维持时间	(20~40) seconds
Ramp-down rate	降温速度	6°C/second max
Time 25°C to Peak Temperature	从25°C到最高温度的时间	8 minutes max
Suggest reflow times	建议 reflow次数	3 Times max

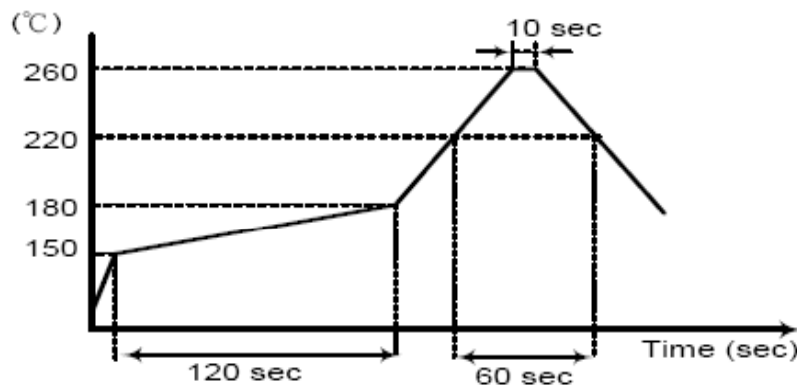

● PACKING (包裝) 3Kpcs/REEL

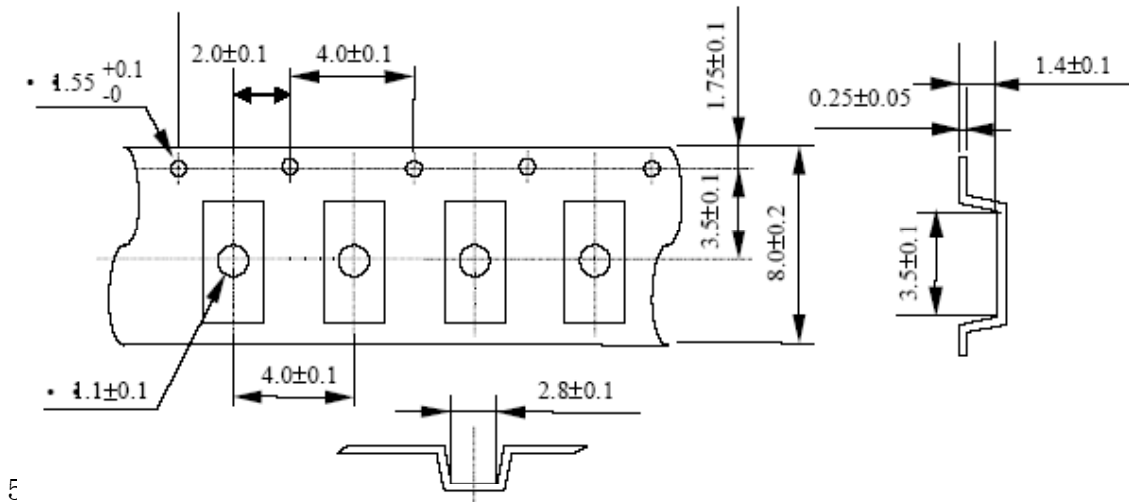

[Size in mm]

8.3. Reel dimension & Outline drawing

Material of the Reel : PS

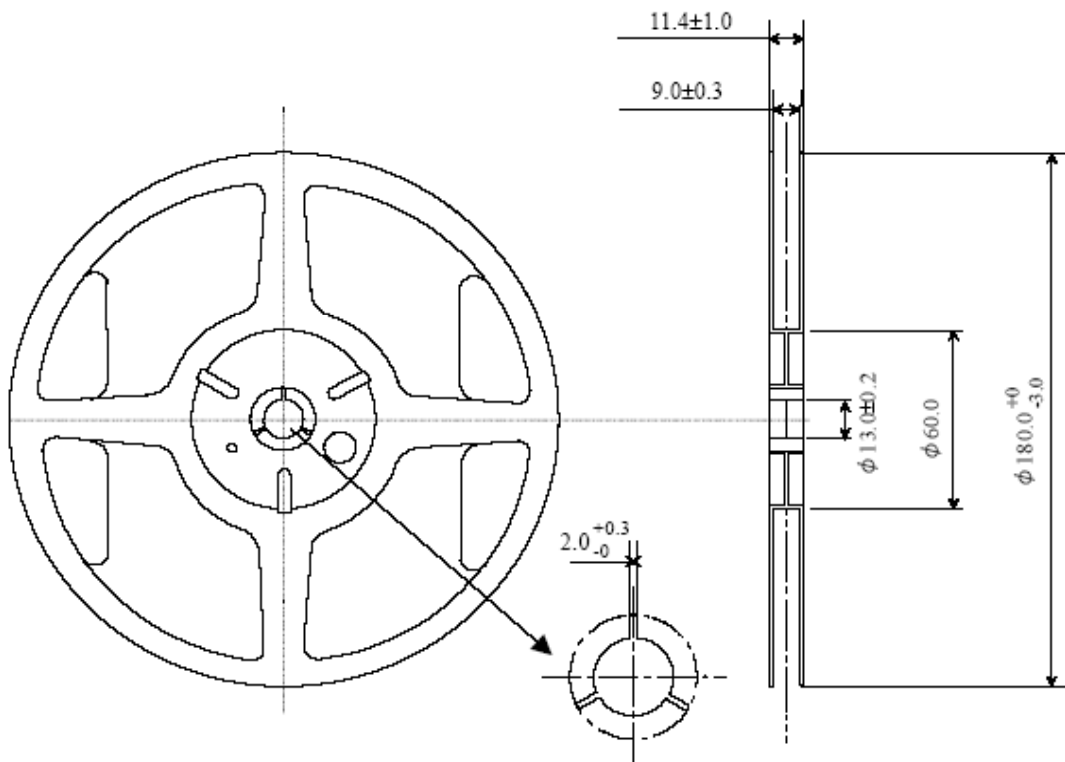

● RELIABILITY SPECIFICATIONS (信赖度试验)

No	Test Item (测试项目)	Test Conditions (测试条件)	Reference (参考)
1	High Temperature High Humidity Storage (高温、高湿、储存)	Temperature: 85°C±3°C 温度: 85°C±3°C Relative Humidity:85%RH 相对湿度: 85%RH Time: 96 Hours 时间: 96小时	JIS C5023
2	High Temperature Storage (高温储存)	Temperature: 125°C±3°C 温度:125°C±3°C Time: 96 Hours 时间:96 小时	MIL-STD-883E Method 1005.8
3	Low Temperature Storage (低温储存)	Temperature: -40°C±3°C 温度: -40°C±3°C Time: 96Hours 时间: 96小时	MIL-STD-883E Method 1013
4	Thermal Shock (温度冲击)	Temperature1:-55°C±5°C 温度1:-55°C±5°C Temperature2:85°C±5°C 温度2: 85°C±5°C Temperature change between T1 and T2 5 min T1和T2温度在5分钟内改变 10cycles maintain T1 and T2 for 30 minutes each mone cycle 每次循环30分钟共10次	MIL-STD-202F Method 107 Condition A
5	RESISTANCE TO SOLDER HEAT (耐焊接热)	Solder Temperature: 260°C±5°C 焊槽温度:260°C±5°C Time: 10±1 Seconds 时间: 10±1秒	MIL-STD-202F Method 210E
6	Solderability(可焊性)	The solder pot temperature is 245±5°C , dwell time 5±0.5sec 245±5°C焊锡槽浸润5±0.5秒	J-STD-002B
7	Drop Test (落下试验)	3 Times Free Fall from 75cm height table to 3cm thickness hard wood board 从75cm高度3次跌落到3cm厚硬质木板上	JIS C6701
8	MECHANICAL SHOCK (机械冲击)	Half sine wave,1000 G 半正弦波,加速度1000G 3 Times for all 3 directions X、Y、Z 三个相互垂直方向各三次	MIL-STD-202F Method 213B
9	Vibration (机械振动)	Frequency Range: 10Hz~55Hz 频率范围: 10Hz~55Hz Amplitude: 0.75mm 振幅: 0.75mm 2 Hours in each direction, total 6 Hours X、Y、Z 三个相互垂直方向各振动2小时	MIL-STD-883E Method 2007.3
10	Leakage Test (气密性)	Take measurements with a helium Leakage detector 氦质检漏 Leakage Rate≤1×10 <sup>-3</sup> Pa cm <sup>3</sup> /s 漏率≤1×10 <sup>-3</sup> Pa cm <sup>3</sup> /s	MIL-STD-883E