

## 2A 2MHz 5.5V Synchronous Buck Converter

### DESCRIPTION

The BL8039 is a high-efficiency, DC-to-DC step-down switching regulators, capable of delivering up to 2A of output current. The device operates from an input voltage range of 2.6V to 5.5V and provides an output voltage from 0.6V to  $V_{IN}$ . Working at a fixed frequency of 2MHz allows the use of small external components, such as ceramic input and output caps, as well as small inductors, while still providing low output ripples. This low noise output along with its excellent efficiency achieved by the internal synchronous rectifier, making BL8039 an ideal replacement for large power consuming linear regulators. Internal soft-start control circuitry reduces inrush current. Short-circuit and thermal shutdown protection improves design reliability.

The BL8039 is available in SOT23-5 package.

### FEATURES

- High efficiency: up to 97%
- Up to 2A Max output current
- Output voltage range:  $V_{REF}$  to  $V_{IN}$
- 2MHz switching frequency
- Low dropout 100% duty operation
- Internal compensation and soft-start
- Current mode control
- Reference  $0.6V \pm 2\%$
- Logic control shutdown ( $I_{q} < 1\mu A$ )
- Thermal shutdown, UVLO
- Available in SOT23-5

### APPLICATIONS

- Cellular phones
- Digital cameras
- MP3 and MP4 players
- Set top boxes
- Wireless and DSL modems
- USB supplied devices in notebooks
- Portable devices

### TYPICAL APPLICATION

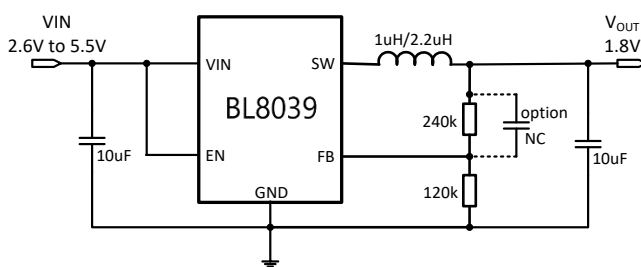

### PIN OUT & MARKING

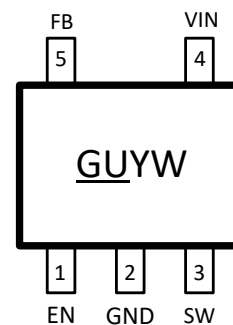

*GU: Product code*

*YW: Date code (Year & Week)*

## ORDERING INFORMATION

Part No.	Package	Tape&Reel
BL8039CB5TR	SOT23-5	3000pcs/reel

## ABSOLUTE MAXIMUM RATING

Parameter	Value
Max input voltage	8V
Max operating junction temperature(T <sub>J</sub> )	125°C
Ambient temperature(T <sub>A</sub> )	-40°C – 85°C
Maximum power dissipation	400mW
Package thermal resistance(θ <sub>JA</sub> )	200°C/W
Storage temperature(T <sub>S</sub> )	-40°C - 150°C
Lead temperature & time	260°C, 10S
ESD (HBM)	>2000V

**Note:** Exceed these limits to damage to the device. Exposure to absolute maximum rating conditions may affect device reliability.

## ELECTRICAL CHARACTERISTICS

(V<sub>IN</sub>=5V, T<sub>A</sub>=25°C, unless otherwise specified.)

Symbol	Parameter	Conditions	Min	Typ	Max	Unit
V <sub>IN</sub>	Input voltage range		2.6		5.5	V
V <sub>OVP</sub>	Input overvoltage threshold			6.1		V
V <sub>REF</sub>	Feedback voltage	V <sub>in</sub> =5V	0.588	0.6	0.612	V
I <sub>FB</sub>	Feedback leakage current			0.1	1	uA
I <sub>Q</sub>	Quiescent current	Active, V <sub>FB</sub> =0.65, No Switching		80		uA
I <sub>SHUTDOWN</sub>	Shutdown input current	EN=0V			1	uA
LNR	Line regulation	V <sub>in</sub> =2.6V to 5.5V		0.1	0.2	%/V
LDR	Load regulation	I <sub>out</sub> =0.01 to 1A		0.1	0.2	%/A
F <sub>SOC</sub>	Switching frequency		1.6	2	2.4	MHz
R <sub>DSON_P</sub>	PMOS Rdson			180		mohm
R <sub>DSON_N</sub>	NMOS Rdson			130		mohm
V <sub>UVLO</sub>	Under voltage lockout		1.9	2.1	2.3	V
V <sub>UVLO_HY</sub>	UVLO hysteresis			100		mV
I <sub>LIMIT</sub>	Peak current limit			2.7	3.3	A
I <sub>NOLOAD</sub>		V <sub>in</sub> =5V, V <sub>out</sub> =3.3V, I <sub>out</sub> =0A		80		uA
I <sub>SWLK</sub>	SW leakage current	V <sub>in</sub> =6V, V <sub>SW</sub> =0 or 6V, EN=0V			1	uA
I <sub>ENLK</sub>	EN leakage current				1	uA
V <sub>H_EN</sub>	EN input high voltage		1.2			V
V <sub>L_EN</sub>	EN input low voltage				0.5	V
T <sub>SD</sub>	Thermal shutdown temp			160		°C
T <sub>SH</sub>	Thermal shutdown hysteresis			15		°C

## ELECTRICAL PERFORMANCE

Tested under  $T_A=25^{\circ}\text{C}$ , unless otherwise specified

### Efficiency vs. Output Current ( $V_{out}=1.8\text{V}$ )

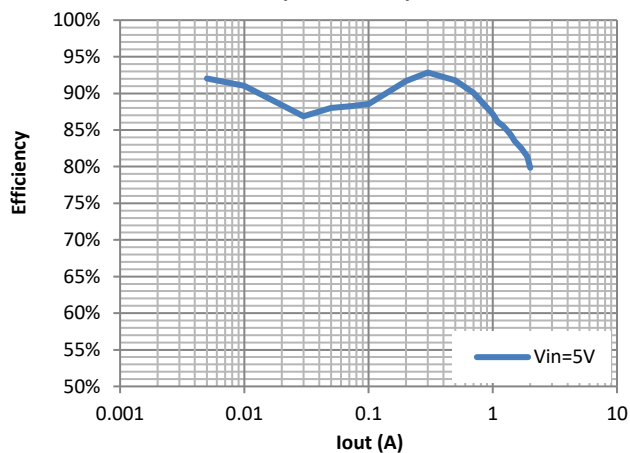

### Efficiency vs. Output Current ( $V_{out}=3.3\text{V}$ )

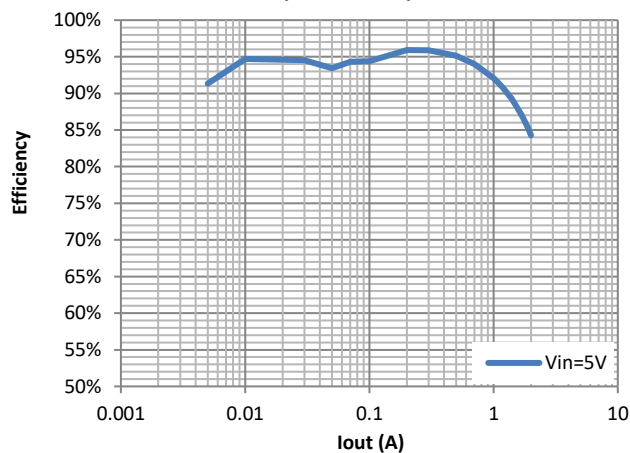

### Load Regulation ( $V_{out}=1.8\text{V}$ )

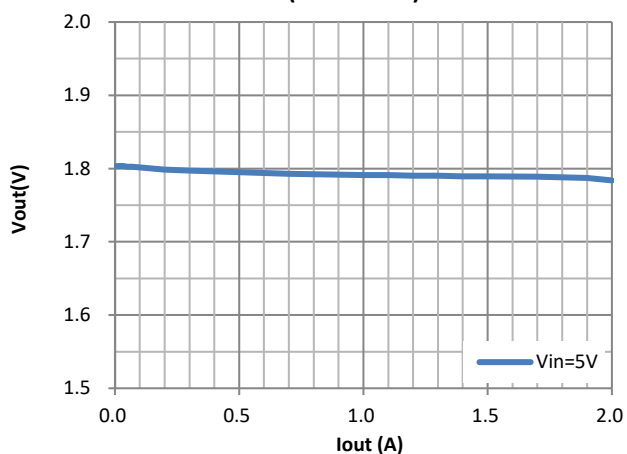

### Load Regulation ( $V_{out}=3.3\text{V}$ )

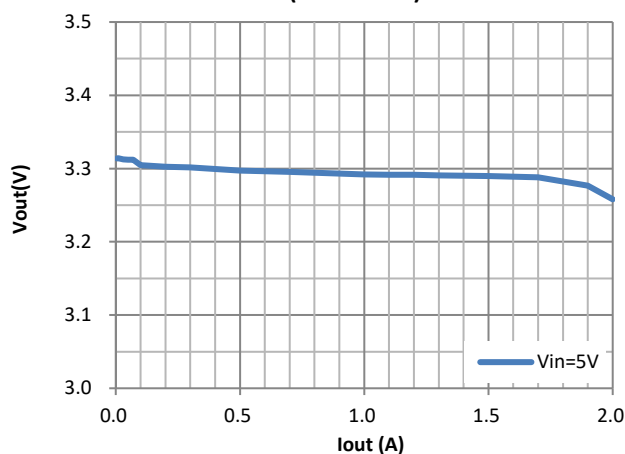

### Output Ripple and SW at 1A load $V_{in}=5\text{V} / V_{out}=1.2\text{V}$

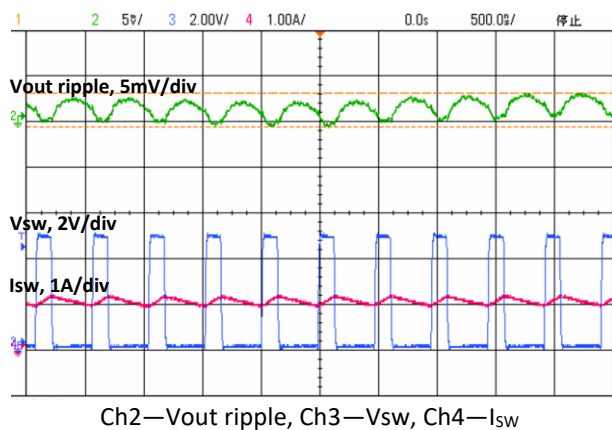

### Output Ripple and SW at 1A load $V_{in}=5\text{V} / V_{out}=1.8\text{V}$

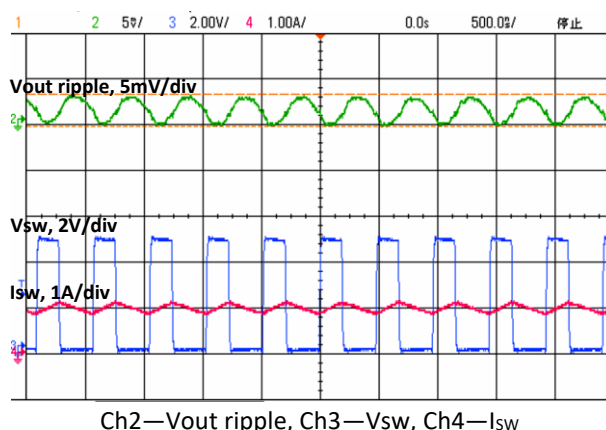

**Output Ripple and SW at 1A load**  
 Vin=5V / Vout=2.5V

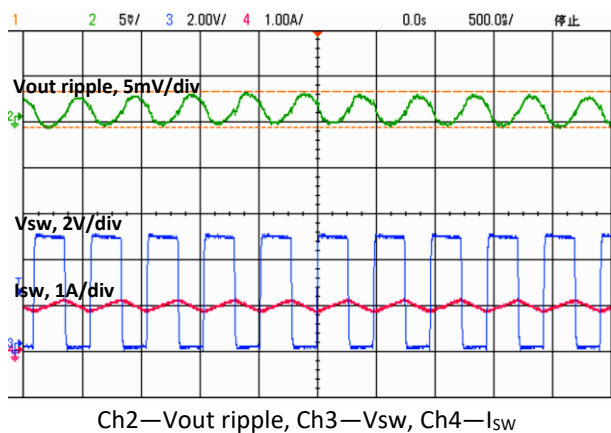

**Output Ripple and SW at 1A load**  
 Vin=5V / Vout=3.3V

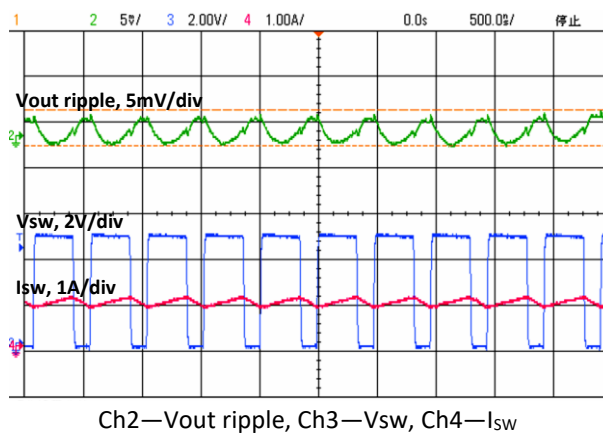

**Load Transient**

Vin=5V / Vout=1.2V / Iout=0.01~1.8A

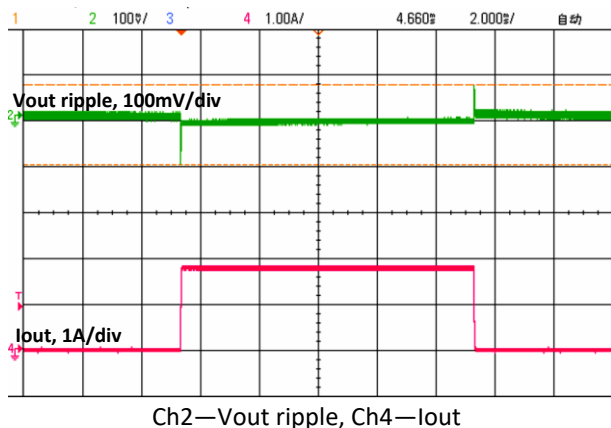

**Load Transient**

Vin=5V / Vout=1.8V / Iout=0.01~1.8A

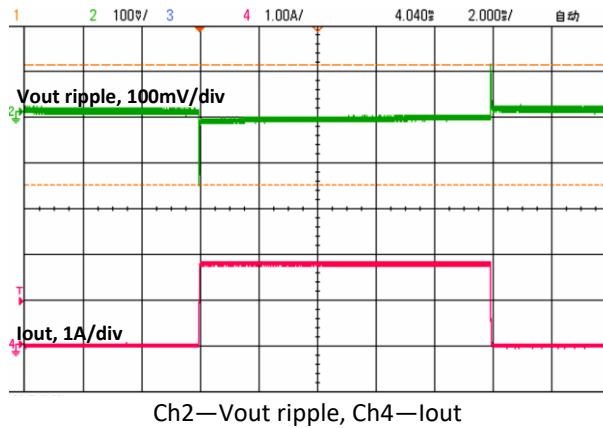

**Load Transient**

Vin=5V / Vout=2.5V / Iout=0.01~1.8A

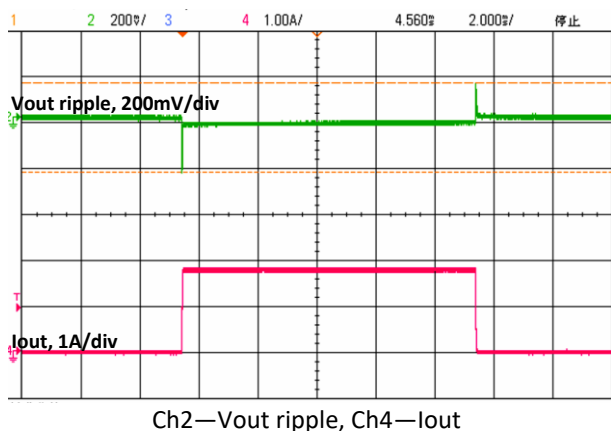

**Load Transient**

Vin=5V / Vout=3.3V / Iout=0.01~1.8A

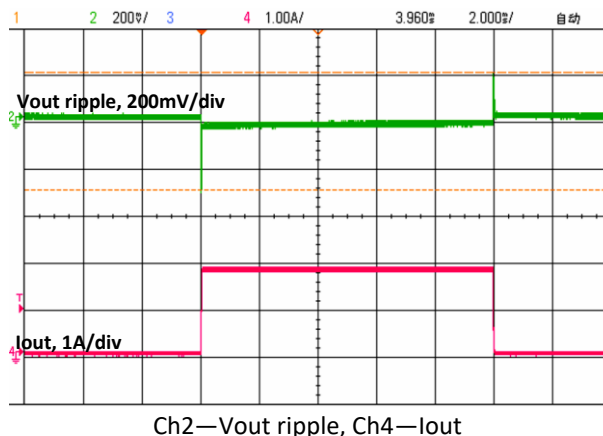

## PIN DESCRIPTION

Pin #	Name	Description
1	EN	Enable pin for the IC. Drive the pin to high to enable the part, and low to disable.
2	GND	Ground.
3	SW	Inductor connection. Connect an inductor between SW and the regulator output.
4	VIN	Supply voltage.
5	FB	Feedback input. Connect an external resistor divider from the output to FB and GND to set the output to a voltage between 0.6V and $V_{in}$ .

## BLOCK DIAGRAM

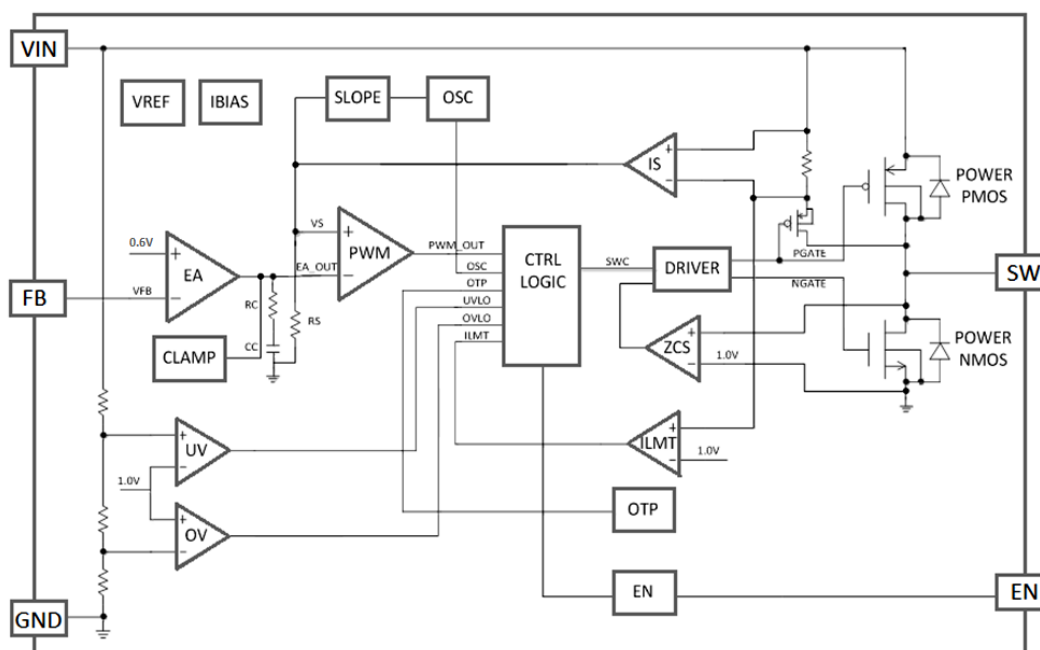

## DETAILED DESCRIPTION

The BL8039 high-efficiency switching regulator is a small, simple, DC-to-DC step-down converter capable of delivering up to 2A of output current. The device operates in pulse-width modulation (PWM) at 2MHz from a 2.6V to 5.5V input voltage and provides an output voltage from 0.6V to  $V_{in}$ , making the BL8039 ideal for on-board post-regulation applications. An internal synchronous rectifier improves efficiency and eliminates the typical Schottky free-wheeling diode. Using the on resistance of the internal high-side MOSFET to sense switching currents eliminates current-sense resistors, further improving efficiency and cost.

### Loop operation

BL8039 uses a PWM current-mode control scheme. An open-loop comparator compares the integrated voltage-feedback signal against the sum of the amplified current-sense signal and the slope

compensation ramp. At each rising edge of the internal clock, the internal high-side MOSFET turns on until the PWM comparator terminates the on cycle. During this on-time, current ramps up through the inductor, sourcing current to the output and storing energy in the inductor. The current mode feedback system regulates the peak inductor current as a function of the output voltage error signal. During the off cycle, the internal high-side P-channel MOSFET turns off, and the internal low-side N-channel MOSFET turns on. The inductor releases the stored energy as its current ramps down while still providing current to the output.

### Current sense

An internal current-sense amplifier senses the current through the high-side MOSFET during on time and produces a proportional current signal, which is used to sum with the slope compensation

signal. The summed signal then is compared with the error amplifier output by the PWM comparator to terminate the on cycle.

### Current limit

There is a cycle-by-cycle current limit on the high-side MOSFET of 2.7A (typ). When the current flowing out of SW exceeds this limit, the high-side MOSFET turns off and the synchronous rectifier turns on. BL8039 utilizes a frequency fold-back mode to prevent overheating during short-circuit output conditions. The device enters frequency fold-back mode when the FB voltage drops below 100mV, limiting the current to 2.7A (typ) and reducing power dissipation. Normal operation resumes upon removal of the short-circuit condition.

### Soft-start

BL8039 has an internal soft-start circuitry to reduce supply inrush current during startup conditions. When the device exits under-voltage lockout

(UVLO), shutdown mode, or restarts following a thermal shutdown event, the soft-start circuitry slowly ramps up current available at SW.

### UVLO

If VIN drops below 2.1V, the UVLO circuit inhibits switching. Once VIN rises above 2.2V, the UVLO clears, and the soft-start sequence activates.

### Thermal shutdown

Thermal shutdown protection limits total power dissipation in the device. When the junction temperature exceeds  $T_J = +160^\circ\text{C}$ , a thermal sensor forces the device into shutdown, allowing the die to cool. The thermal sensor turns the device on again after the junction temperature cools by  $15^\circ\text{C}$ , resulting in a pulsed output during continuous overload conditions. Following a thermal-shutdown condition, the soft-start sequence begins.

## DESIGN PROCEDURE

### Setting output voltages

Output voltages are set by external resistors. The FB threshold is 0.6V.

$$R_{TOP} = R_{BOTTOM} \times \left( \frac{V_{OUT}}{0.6} - 1 \right)$$

### Input capacitor selection

The input capacitor in a DC-to-DC converter reduces current peaks drawn from the battery or other input power source and reduces switching noise in the controller. The impedance of the input capacitor at the switching frequency should be less than that of the input source so high-frequency switching currents do not pass through the input source. The output capacitor keeps output ripple small and ensures control-loop stability. The output capacitor must also have low impedance at the

switching frequency. Ceramic, polymer, and tantalum capacitors are suitable, with ceramic exhibiting the lowest ESR and high-frequency impedance. Output ripple with a ceramic output capacitor is approximately as follows:

$$\Delta I_L = \frac{V_{OUT}}{L \times f_S} \times \left( 1 - \frac{V_{OUT}}{V_{IN}} \right)$$

$$\Delta V_{OUT} = \frac{V_{OUT}}{8 \times f_S^2 \times L \times C_{OUT}} \times \left( 1 - \frac{V_{OUT}}{V_{IN}} \right)$$

If the capacitor has significant ESR, the output ripple component due to capacitor ESR is as follows:

$$\Delta V_{OUT} = \frac{V_{OUT}}{f_S \times L} \times \left( 1 - \frac{V_{OUT}}{V_{IN}} \right) \times R_{ESR}$$

## LAYOUT GUIDE

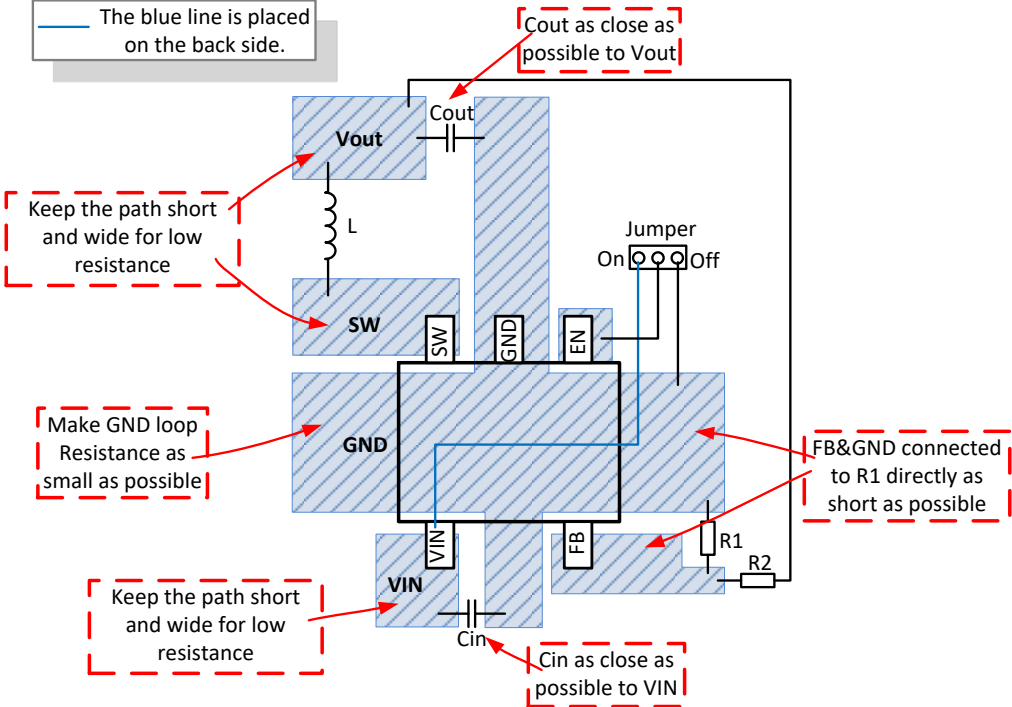

## PACKAGE OUTLINE

Package	SOT23-5	Devices per reel	3000pcs
Package specification:			
<p>Dimensions (mm):</p> <ul style="list-style-type: none"> <li>Total width: <math>2.9 \pm 0.2</math></li> <li>Distance between pins 1 and 5: <math>1.9 \pm 0.2</math></li> <li>Pin pitch: <math>0.95</math></li> <li>Pin 1 width: <math>0.4 \pm 0.1</math></li> <li>Pin 2 width: <math>0.4 \pm 0.1</math></li> <li>Pin 3 width: <math>0.4 \pm 0.1</math></li> <li>Pin 4 width: <math>0.4 \pm 0.1</math></li> <li>Pin 5 width: <math>0.4 \pm 0.1</math></li> <li>Body height: <math>1.6 \pm 0.1</math></li> <li>Body length: <math>2.8 \pm 0.3</math></li> <li>Pin 1 height: <math>1.1 \pm 0.2</math></li> <li>Pin 2 height: <math>0.8 \pm 0.1</math></li> <li>Pin 3 height: <math>0.15 \pm 0.1</math></li> <li>Pin 4 height: <math>0.15 \pm 0.1</math></li> <li>Pin 5 height: <math>0.15 \pm 0.1</math></li> <li>Minimum pin length: <math>0.2 \text{ MIN.}</math></li> <li>Lead thickness: <math>0 \text{ to } 0.1</math></li> </ul>			
Unit: mm			