



3W Filterless Mono Class-D Audio Power Amplifier

General Description

The MD4103 is a 3W high efficiency filterless mono class-D audio power amplifier in a MSOP8 package, and a DFN package that requires only three external components, it has high PSRR and differential input that eliminate noise and RF rectification.

The MD4103 features like 90% efficiency and small PCB area make the MD4103 class-D amplifier ideal for cellular handsets. A low noise, filterless PWM architecture eliminates the output filter, reducing external component count, system cost, and simplifying design.

The MD4103 features short circuit protection and OTP(over temperature protection) thermal shutdown and UVLO(under voltage lockout).

The MD4103 is available in MSOP-8, and DFN2x2-8 package.

Features

- P_o at 10% THD+N, $V_{DD} = 5V$
 $R_L = 4\ \Omega$ 3.0W (typ)
 $R_L = 8\ \Omega$ 1.8W (typ)
- P_o at 1% THD+N, $V_{DD} = 5V$
 $R_L = 4\ \Omega$ 2.5W (typ)
 $R_L = 8\ \Omega$ 1.45W (typ)
- Superior Low Noise
- Filterless and Low EMI
- Less external components required
- High efficiency up to 90%
- Thermal and over current Protections
- RoHS compliant and 100% lead(Pb)-free

Applications

- Mobile Phones
- PDA, GPS
- Portable Electronic Devices
- Desktop Speaker

Block Diagram

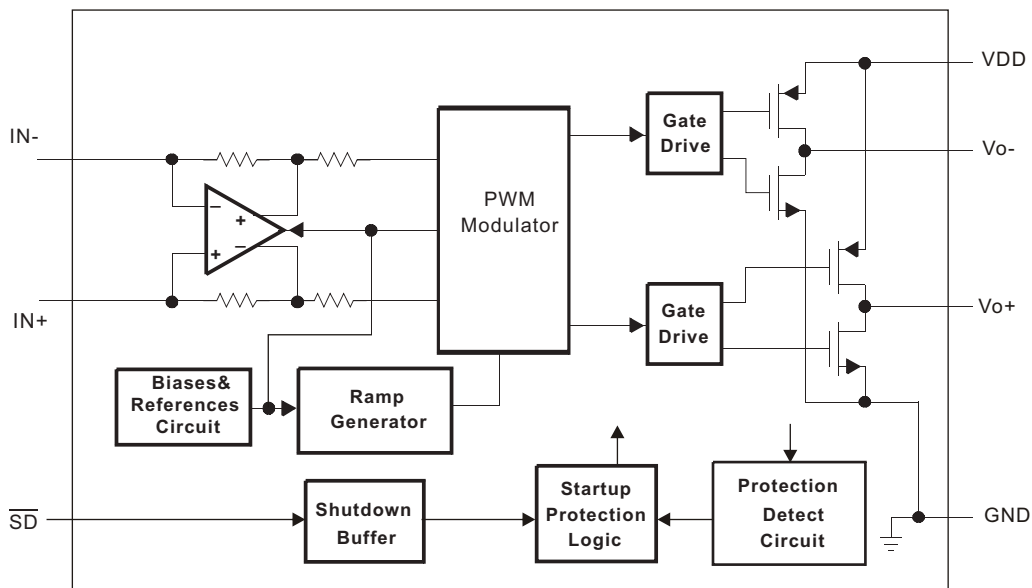



3W Filterless Mono Class-D Audio Power Amplifier

Pin Configuration

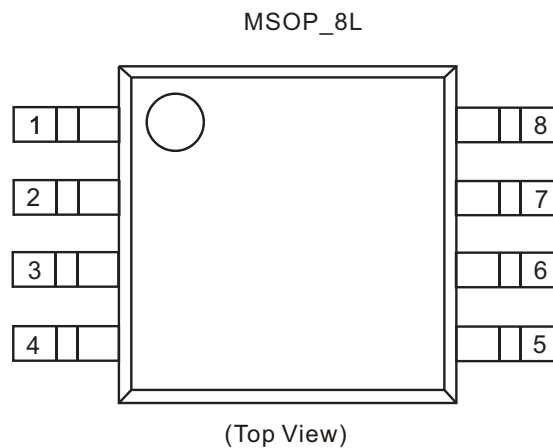
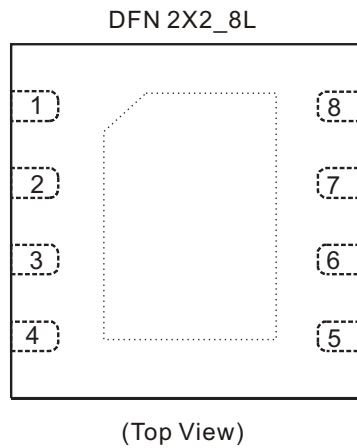

Pin Descriptions

Pin #		Symbol	Description
MSOP8	DFN-8		
1	1	\overline{SD}	Shutdown terminal, active low
2	2	NC	No internal connection
3	3	IN+	Positive differential input
4	4	IN-	Negative differential input
5	5	VO-	Negative BTL output
6	6	VDD	Analog power supply
7	7	GND	Ground
8	8	VO+	Positive BTL output



3W Filterless Mono Class-D Audio Power Amplifier

Typical Application

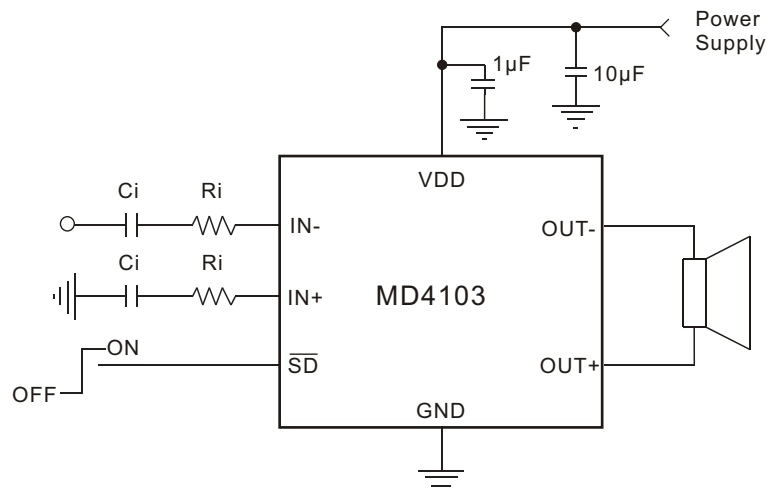

Figure 1. Single-ended Input Configuration

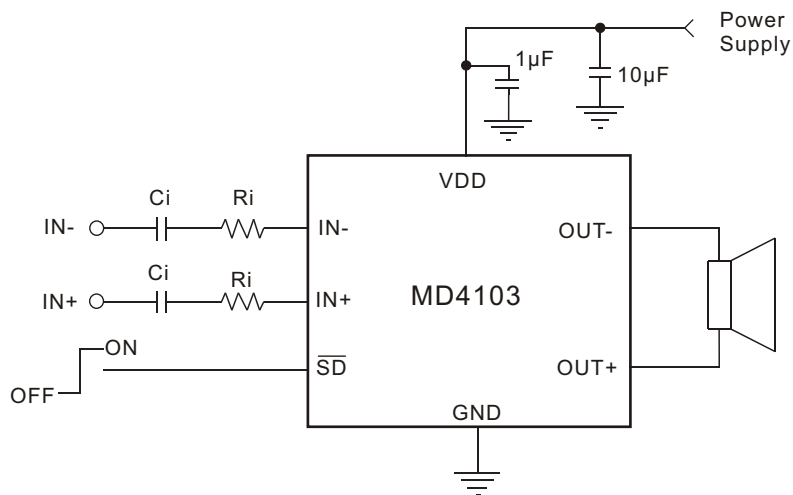

Figure 2. Differential Input Configuration



3W Filterless Mono Class-D Audio Power Amplifier

Absolute Maximum Ratings¹

Symbol	Description	Value	Unit
V _{DD}	Supply Voltage at no Input Signal	6	V
V _I	Input Voltage	-0.3 to VDD+0.3	V
T _J	Operating Junction Temperature Range	-40 to 150	°C
T _{SDR}	Maximum Lead Soldering Temperature , 10 Seconds	260	°C
T _{STG}	Storage Temperature Range	-65 to 150	°C

Recommended Operating Conditions

Symbol	Description	Value	Unit
V _{DD}	Supply Voltage	2.4~5.5	V
T _A	Ambient Temperature Range	-40~85	°C
T _J	Junction Temperature Range	-40~125	°C

Thermal Information²

Symbol	Description	Value	Unit
θ _{JA} (MSOP8)	Thermal Resistance-Junction to Ambient	160	°C/W
θ _{JC} (MSOP8)	Thermal Resistance-Junction to Case	56	°C/W
θ _{JA} (DFN2X2-8)	Thermal Resistance-Junction to Ambient	55	°C/W
θ _{JC} (DFN2X2-8)	Thermal Resistance-Junction to Case	10	°C/W

Ordering and Marking Information

Device	Package Type	Device Marking	Reel Size	Tape Width	Quantity
MD4103D	DFN 2X2_8L		7"	8mm	3000 units
MD4103S	MSOP_8L		13"	12mm	3000 units

ESD Susceptibility

ESD Susceptibility-HBM ----- 2kV
ESD Susceptibility-MM ----- 200V

- Stresses above those listed in Absolute Maximum Ratings may cause permanent damage to the device. Functional operation at conditions other than the operating conditions specified is not implied. Only one Absolute Maximum Rating should be applied at one time.
- The ThermalPad on the bottom of the IC should be soldered directly to the PCB's ThermalPad area that has several thermal vias connect to the ground plane, and the PCB is a 2-layer, 5-inch square area with 2oz copper thickness.



3W Filterless Mono Class-D Audio Power Amplifier

Electrical Characteristics

$T_A=25^{\circ}\text{C}$, $V_{DD}=5\text{V}$, Gain=2V/V, $R_L=L(33\mu\text{H})+R+L(33\mu\text{H})$, unless otherwise noted.

Symbol	Parameter	Test Conditions	Min	Typ	Max	Unit
$ V_{OS} $	Output offset voltage (measured differentially)	$V_I=0\text{V}$, $A_V=2\text{V/V}$, $V_{DD}=2.7\text{V}$ to 5.5V		1	25	mV
PSRR	Power supply rejection ratio	$V_{DD}=2.7\text{V}$ to 5.5V		-75	-55	dB
CMRR	Common mode rejection ratio	$V_{DD}=2.7\text{V}$ to 5.5V		-65	-50	dB
$ I_{IH} $	High-level input current	$V_{DD}=5.5\text{V}$, $V_I=5.5\text{V}$			50	μA
$ I_{IL} $	Low-level input current	$V_{DD}=5.5\text{V}$, $V_I=-0.3\text{V}$			5	μA
$I_{(Q)}$	Quiescent current	$V_{DD}=5.5\text{V}$, no load		3.8	5	mA
		$V_{DD}=3.6\text{V}$, no load		3.0		
$I_{(SD)}$	Shutdown current	$V_{(\overline{\text{SHUTDOWN}})}=0.35\text{V}$, $V_{DD}=2.7\text{V}$ to 5.5V		0.1	2	μA
$r_{DS(ON)}$	Static Drain-source On-state Resistance	$V_{DD}=3.6\text{V}$		400		m Ω
		$V_{DD}=5.5\text{V}$		350		
	Output impedance in SHUTDOWN	$V_{(\overline{\text{SHUTDOWN}})}=0.35\text{V}$		2		k Ω
$f_{(SW)}$	Switching frequency	$V_{DD}=2.7\text{V}$ to 5.5V		250		kHz
	Gain	$V_{DD}=2.7\text{V}$ to 5.5V		$\frac{300\text{k}\Omega}{R_i}$		$\frac{\text{V}}{\text{V}}$
	Resistance from shutdown to GND			300		k Ω



3W Filterless Mono Class-D Audio Power Amplifier

Electrical Characteristic (continued)

$T_A = 25^\circ\text{C}$, $V_{DD} = 5\text{V}$, Gain = 2V/V, $R_L = L(33\ \mu\text{H}) + R + L(33\ \mu\text{H})$, unless otherwise noted.

Symbol	Parameter	Test Conditions	Min	Typ	Max	Unit
P _O	Output power	V _{DD} =5.0V R _L =3Ω	THD+N = 1% f = 1kHz	2.90		W
			THD+N = 10% f = 1kHz	3.63		W
		V _{DD} =4.2V R _L =3Ω	THD+N = 1% f = 1kHz	2.07		W
			THD+N = 10% f = 1kHz	2.58		W
		V _{DD} =3.8V R _L =3Ω	THD+N = 1% f = 1kHz	1.69		W
			THD+N = 10% f = 1kHz	2.09		W
		V _{DD} =3.6V R _L =3Ω	THD+N = 1% f = 1kHz	1.50		W
			THD+N = 10% f = 1kHz	1.86		W
		V _{DD} =3.0V R _L =3Ω	THD+N = 1% f = 1kHz	1.00		W
			THD+N = 10% f = 1kHz	1.25		W
		V _{DD} =5.0V R _L =4Ω	THD+N = 1% f = 1kHz	2.50		W
			THD+N = 10% f = 1kHz	3.09		W
		V _{DD} =4.2V R _L =4Ω	THD+N = 1% f = 1kHz	1.77		W
			THD+N = 10% f = 1kHz	2.18		W
		V _{DD} =3.8V R _L =4Ω	THD+N = 1% f = 1kHz	1.43		W
			THD+N = 10% f = 1kHz	1.77		W
		V _{DD} =3.6V R _L =4Ω	THD+N = 1% f = 1kHz	1.27		W
			THD+N = 10% f = 1kHz	1.58		W
		V _{DD} =3.0V R _L =4Ω	THD+N = 1% f = 1kHz	0.85		W
			THD+N = 10% f = 1kHz	1.07		W
		V _{DD} =5.0V R _L =8Ω	THD+N = 1% f = 1kHz	1.45		W
			THD+N = 10% f = 1kHz	1.79		W
		V _{DD} =4.2V R _L =8Ω	THD+N = 1% f = 1kHz	1.02		W
			THD+N = 10% f = 1kHz	1.26		W
V _{DD} =3.8V R _L =8Ω	THD+N = 1% f = 1kHz	0.83		W		
	THD+N = 10% f = 1kHz	1.02		W		
V _{DD} =3.6V R _L =8Ω	THD+N = 1% f = 1kHz	0.74		W		
	THD+N = 10% f = 1kHz	0.92		W		
V _{DD} =3.0V R _L =8Ω	THD+N = 1% f = 1kHz	0.51		W		
	THD+N = 10% f = 1kHz	0.63		W		



3W Filterless Mono Class-D Audio Power Amplifier

Electrical Characteristic (continued)

$T_A=25^{\circ}\text{C}$, $V_{DD}=5\text{V}$, Gain=2V/V, $R_L=L(33\mu\text{H})+R+L(33\mu\text{H})$, unless otherwise noted.

Symbol	Parameter	Test Conditions	Min	Typ	Max	Unit
THD+N	Total harmonic distortion plus noise	$V_{DD}=5.0\text{V}$, $P_O=1.0\text{W}$, $R_L=3\Omega$, $f=1\text{kHz}$		0.087		%
		$V_{DD}=5.0\text{V}$, $P_O=1.0\text{W}$, $R_L=4\Omega$, $f=1\text{kHz}$		0.061		%
		$V_{DD}=3.8\text{V}$, $P_O=1.0\text{W}$, $R_L=4\Omega$, $f=1\text{kHz}$		0.064		%
		$V_{DD}=3.6\text{V}$, $P_O=1.0\text{W}$, $R_L=4\Omega$, $f=1\text{kHz}$		0.065		%
		$V_{DD}=5.0\text{V}$, $P_O=0.8\text{W}$, $R_L=8\Omega$, $f=1\text{kHz}$		0.038		%
		$V_{DD}=3.8\text{V}$, $P_O=0.6\text{W}$, $R_L=8\Omega$, $f=1\text{kHz}$		0.055		%
		$V_{DD}=3.6\text{V}$, $P_O=0.5\text{W}$, $R_L=8\Omega$, $f=1\text{kHz}$		0.054		%
k_{SVR}	Supply ripple rejection ratio	$V_{DD}=3.6\text{V}$, Inputs ac-grounded with $C_i=2\mu\text{F}$		-70		dB
		$f=217\text{Hz}$, $V_{(RIPPLE)}=200\text{mV}_{pp}$				
SNR	Signal-to-noise ration	$V_{DD}=5\text{V}$, $P_O=1\text{W}$, $R_L=8\Omega$		95		dB
V_n	Output voltage noise	$V_{DD}=5\text{V}$, Inputs ac-grounded with $C_i=1\mu\text{F}$		46		μV_{RMS}
		No weighting				
CMRR	Common mode rejection ratio	$V_{DD}=3.6\text{V}$, $V_{IC}=1\text{V}_{pp}$		-65		dB
		$f=217\text{Hz}$				
Z_i	Input impedance			150		$\text{k}\Omega$
	Start-up time from shutdown	$V_{DD}=3.6\text{V}$		32		ms



3W Filterless Mono Class-D Audio Power Amplifier

Typical Operating Characteristics

$T_A=25^\circ\text{C}$, $V_{DD}=5\text{V}$, $f=1\text{kHz}$, $\text{Gain}=2\text{V/V}$, unless otherwise noted.

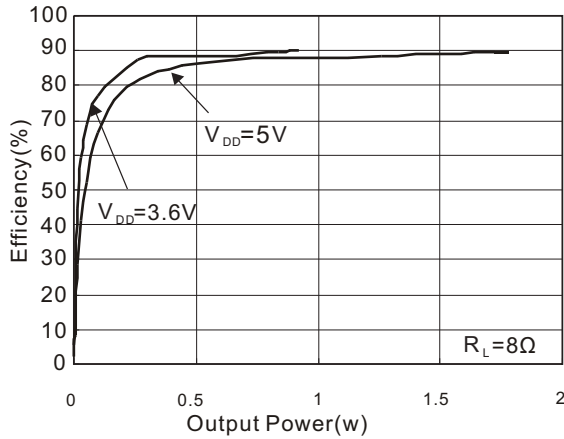

Figure 3. Efficiency vs Output Power

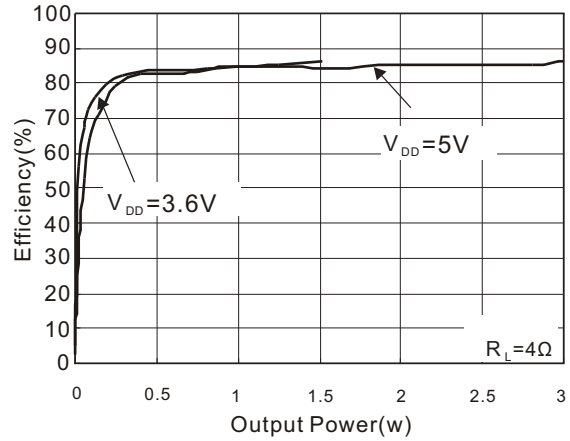

Figure 4. Efficiency vs Output Power

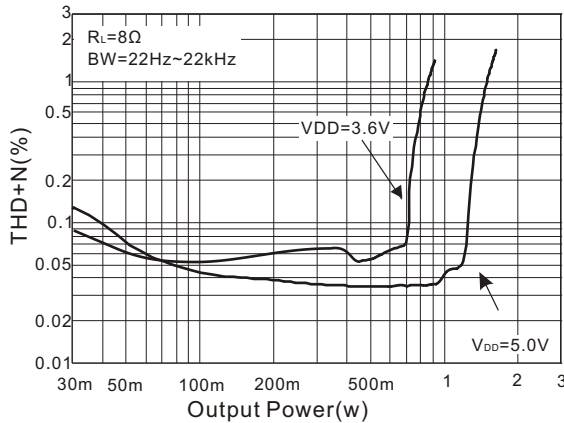

Figure 5. THD+N vs Output Power

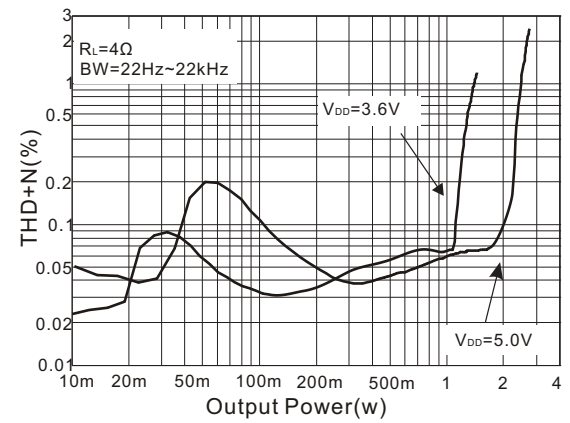

Figure 6. THD+N vs Output Power

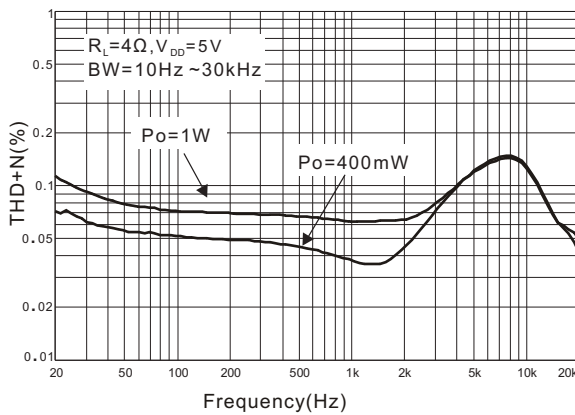

Figure 7. THD+N vs Frequency

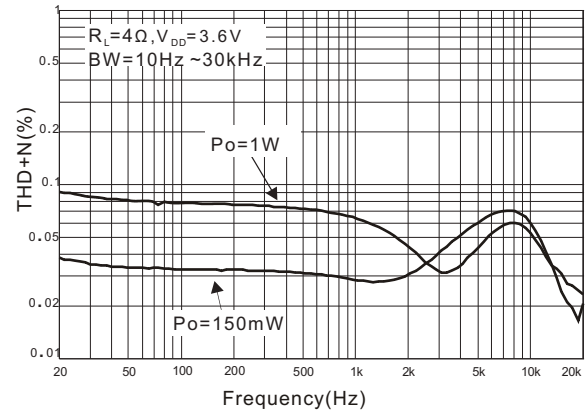

Figure 8. THD+N vs Frequency



3W Filterless Mono Class-D Audio Power Amplifier

Typical Operating Characteristics

$T_A=25^{\circ}\text{C}$, $V_{DD}=5\text{V}$, $f=1\text{kHz}$, $\text{Gain}=2\text{V/V}$, unless otherwise noted.

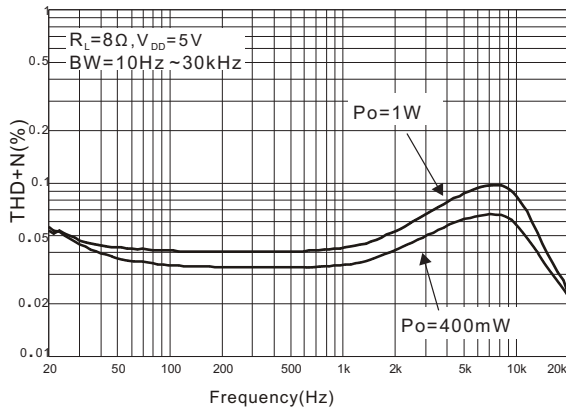

Figure 9. THD+N vs Frequency

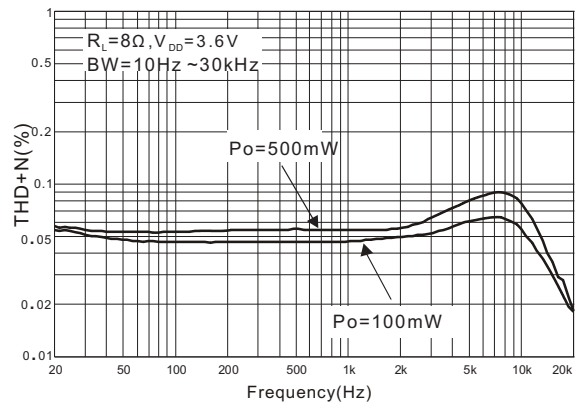

Figure 10. THD+N vs Frequency

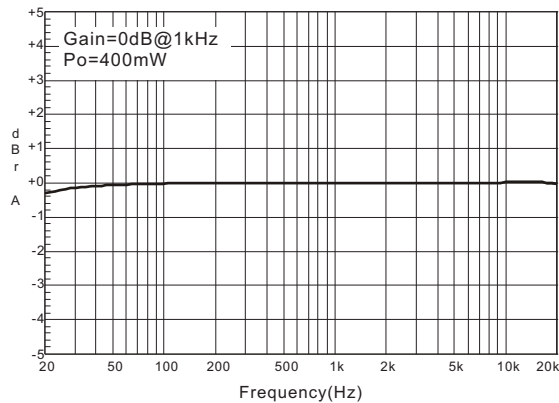

Figure 11. Frequency Response

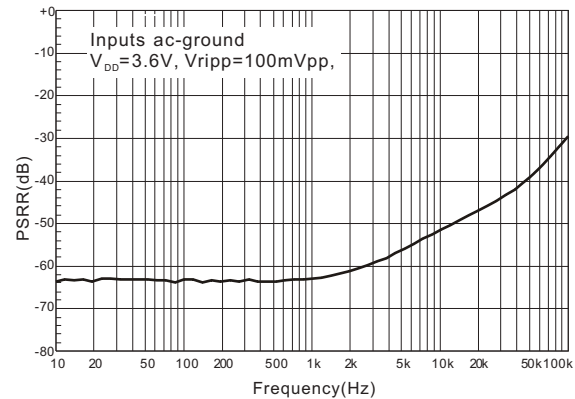

Figure 12. PSRR vs Frequency

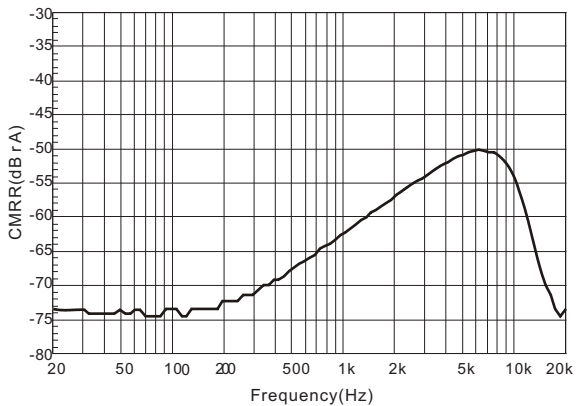

Figure 13. CMRR vs Frequency

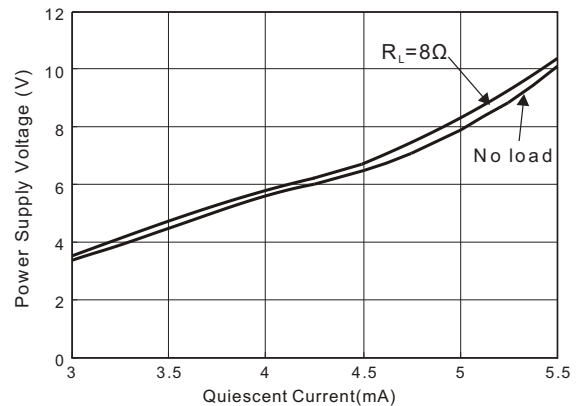

Figure 14. Quiescent Current vs Power Supply Voltage



3W Filterless Mono Class-D Audio Power Amplifier

Typical Operating Characteristics

$T_A=25^{\circ}\text{C}$, $V_{DD}=5\text{V}$, $f=1\text{kHz}$, $\text{Gain}=2\text{V/V}$, unless otherwise noted.

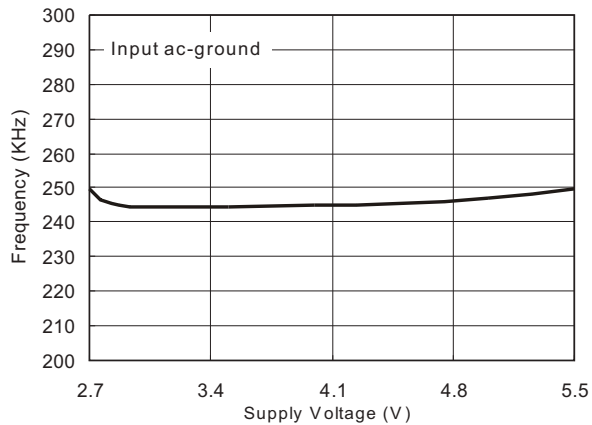

Figure 15. OSC Frequency

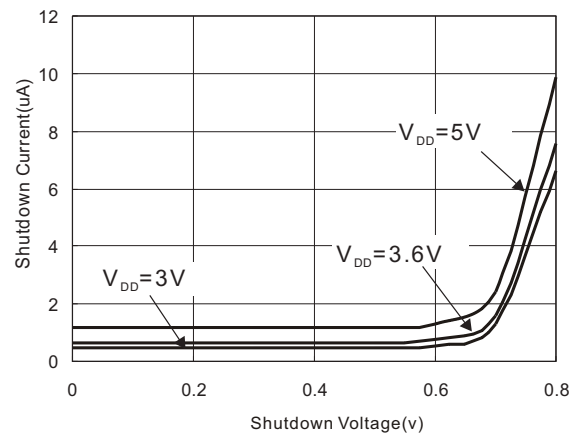

Figure 16. Shutdown Voltage vs Shutdown Current

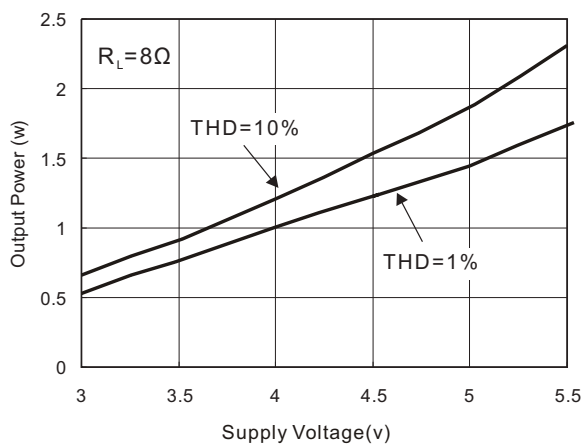

Figure 17. Output Power vs Supply Voltage

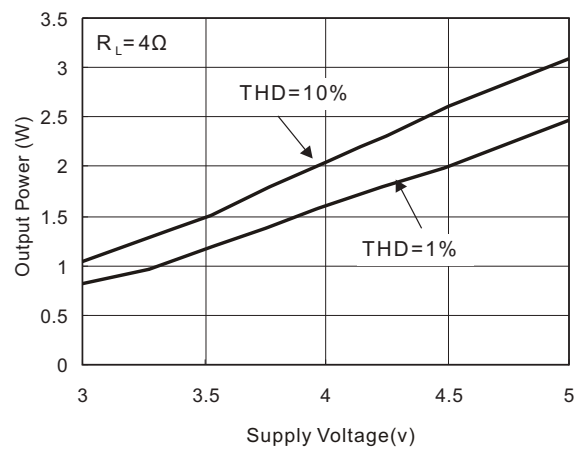
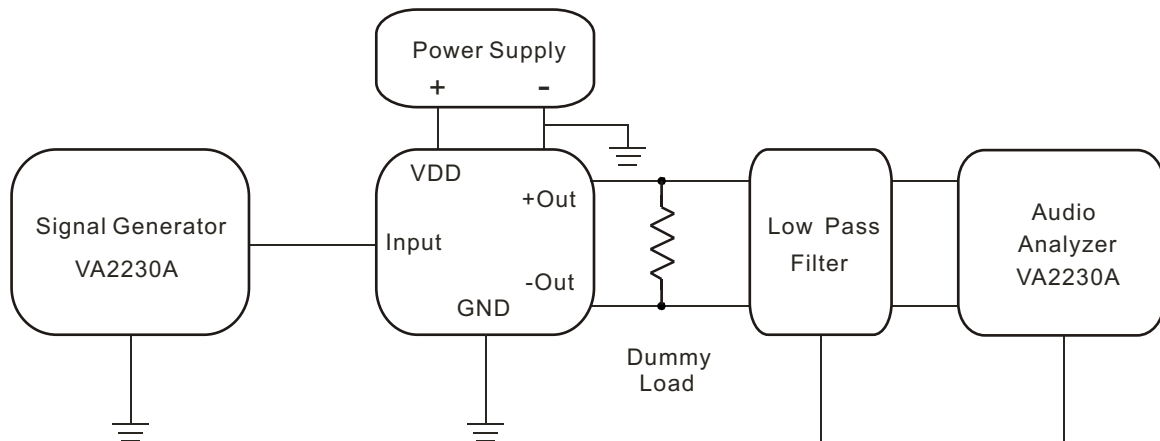

Figure 18. Output Power vs Supply Voltage



3W Filterless Mono Class-D Audio Power Amplifier

Test Connection



Notes

1. A 33- μ H inductor was placed in series with the load resistor to emulate a small speaker for efficiency measurements.
2. The 30-kHz low-pass filter is required even if the analyzer has an internal low-pass filter.



3W Filterless Mono Class-D Audio Power Amplifier

Application Information

Amplifier Function

The MD4103 features a filterless modulation scheme. The differential outputs of the device switch at 250kHz from VDD to GND. When there is no input signal applied, the two outputs (Vo1 and Vo2) switch with a 50% duty cycle, with both outputs in phase. Because the outputs of the MD4103 are differential, the two signals cancel each other. This results in no net voltage across the speaker, thus there is no load current during an idle state, conserving power. With an input signal applied, the duty cycle (pulse width) of the MD4103 outputs changes. For increasing output voltages, the duty cycle of Vo1 increases, while the duty cycle of Vo2 decreases. For decreasing output voltages, the converse occurs, the duty cycle of Vo2 increases while the duty cycle of Vo1 decreases. The difference between the two pulse widths yields the differential output voltage.

Shutdown Function

In order to reduce power consumption while not in use, the MD4103 contains shutdown circuitry that is used to turn off the amplifier's bias circuitry. This shutdown feature turns the amplifier off when logic low is placed on the SD pin. By switching the shutdown pin connected to GND, the MD4103 supply current draw will be minimized in idle mode.

OTP(Over Temperature protection)

Thermal protection on the MD4103 prevents the device from damage when the internal die temperature exceeds 135°C. There is a 15°C tolerance on this trip point from device to device. Once the die temperature exceeds the set point, the device will enter the shutdown state and the outputs are disabled. This is not a latched fault. The thermal fault is cleared once the temperature of the die decreased by 30°C. This large hysteresis will prevent motor boating sound well and the device begins normal operation at this point with no external system interaction.

Short Circuit Protection

The MD4103 has short circuit protection circuitry on the outputs to prevent the device from damage when output-to-output shorts or output-to-GND shorts occur. When a short circuit occurs, the device immediately goes into shutdown state. Once the short is removed, the device will be reactivated.

Click and POP Rejection

The MD4103 contains circuitry to minimize turn-on and turn-off transients or “click and pops”, where turn-on refers to either power supply turn-on or device recover from shutdown mode. When the device is turned on, the amplifiers are internally muted. An internal current source ramps up the internal reference voltage. The device will remain in mute mode until the reference voltage reach half supply voltage, 1/2 VDD. As soon as the reference voltage is stable, the device will begin full operation. For the best power-off pop performance, the amplifier should be set in shutdown mode prior to removing the power supply voltage.

Under Voltage Lock-out (UVLO)

The MD4103 incorporates circuitry designed to detect low supply voltage. When the supply voltage drops to 2.3V or below, the MD4103 goes into a state of shutdown, and the device comes out of its shutdown state and restore to normal function only when reset the power supply or SD pin.

Input Resistance(Ri)

The input resistors (Ri) set the gain of the amplifier according to Equation 1.

$$\text{gain} = \frac{2 \cdot 150\text{k}\Omega}{R_i}$$

For optimal performance the gain should be set to 2X(Ri=150k) or lower. Lower gain allows the MD4103 to operate at its best, and keeps a high voltage at the input making the inputs less susceptible to noise. In addition to these features, higher value of Ri minimizes pop noise. Resistor matching is very important in fully differential amplifiers. The balance of the output on the reference voltage depends on matched ratios of the resistors. CMRR, PSRR, and cancellation of the second harmonic distortion diminish if resistor mismatch occurs. Therefore, it is recommended to use 1% tolerance resistors or better to keep the performance optimized. Matching is more important than overall tolerance. Resistor arrays with 1% matching can be used with a tolerance greater than 1%.



3W Filterless Mono Class-D Audio Power Amplifier

Power Supply Decoupling

The MD4103 is a high-performance CMOS audio amplifier that requires adequate power supply decoupling to ensure the output total harmonic distortion (THD) as low as possible. Power supply decoupling also prevents the oscillations causing by long lead length between the amplifier and the speaker.

The optimum decoupling is achieved by using two different types of capacitors that target on different types of noise on the power supply leads. For higher frequency transients, spikes, or digital hash on the line, a good low equivalent-series-resistance (ESR) ceramic capacitor, typically 1μF, is placed as close as possible to the device each VDD and PVDD pin for the best operation. For filtering lower frequency noise signals, a large ceramic capacitor of 10μF or greater placed near the audio power amplifier is recommended.

Input Capacitors (Ci)

In the typical application, an input capacitor, Ci, is required to allow the amplifier to bias the input signal to the proper DC level for optimum operation. In this case, Ci and the minimum input impedance Ri form a high-pass filter with the corner frequency determined in the follow equation:

$$f_c = \frac{1}{(2\pi R_i C_i)}$$

It is important to consider the value of Ci as it directly affects the low frequency performance of the circuit. For example, when Ri is 150kΩ and the specification calls for a flat bass response are down to 150Hz. Equation is reconfigured as followed:

$$C_i = \frac{1}{(2\pi R_i f_c)}$$

When input resistance variation is considered, the Ci is 7nF, so one would likely choose a value of 10nF. A further consideration for this capacitor is the leakage path from the input source through the input network (Ci,Ri+Rf) to the load. This leakage current creates a DC offset voltage at the input to the amplifier that reduces useful headroom, especially in high gain applications.

For this reason, a low-leakage tantalum or ceramic capacitor is the best choice. When polarized capacitors are used, the positive side of the capacitor should face the amplifier input in most applications as the DC level is held at VDD/2, which is likely higher than the source DC level. Please note that it is important to confirm the capacitor polarity in the application.

Board Layout

It is recommended to use plane grounding or separate grounds. Do not use one line connecting power GND and analog GND. Noise currents in the output power stage need to be returned to output noise ground and nowhere else. When these currents circulate elsewhere, they may get into the power supply, or the signal ground, etc, even worse, they may form a loop and radiate noise. Any of these instances results in degraded amplifier performance. The output noise ground that the logical returns for the output noise currents associated with class D switching must tie to system ground at the power exclusively. Signal currents for the inputs, reference need to be returned to quite ground. This ground only ties to the signal components and the GND pin. GND then ties to system ground.

As same to the ground, VDD and PVDD need to be separately connected to the system power supply. It is recommended that all the trace could be routed as short and thick as possible.

Input resistors and capacitors need to be placed very close to input pins.

Output filter should be placed as close to the output terminals as possible for the best EMI performance, and the capacitors used in the filters should be grounded to system ground.

How to Reduce EMI

Most applications require a ferrite bead filter for EMI elimination shown at Figure 19. The ferrite filter reduces EMI around 1MHz and higher. When selecting a ferrite bead, choose one with high impedance at high frequencies, but low impedance at low frequencies.

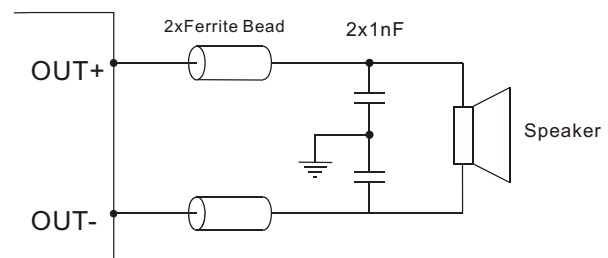

Figure 19: Ferrite Bead Filter to Reduce EMI



3W Filterless Mono Class-D Audio Power Amplifier

Package Information

MSOP_8L

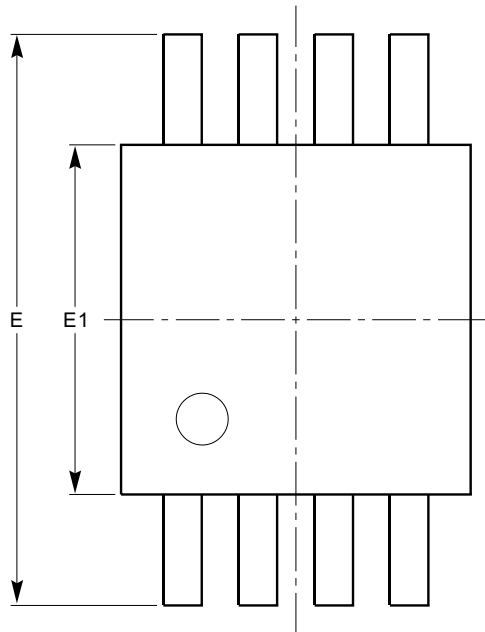

TOP VIEW

SYMBOL	MIN	NOM	MAX
A			1.10
A1	0.05	0.10	0.15
A2	0.75	0.85	0.95
b	0.22		0.38
c	0.13		0.23
D	2.90	3.00	3.10
E	4.80	4.90	5.00
E1	2.90	3.00	3.10
e	0.65 BSC		
L	0.40	0.60	0.80
L1	0.95 REF		
L2	0.25 BSC		
θ	0°		6°

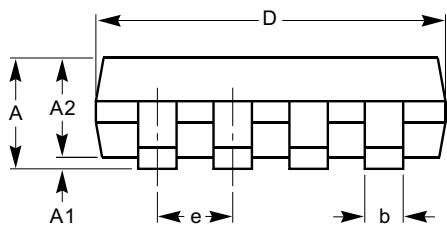

SIDE VIEW

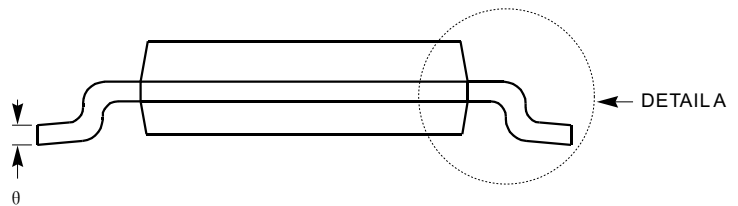

END VIEW

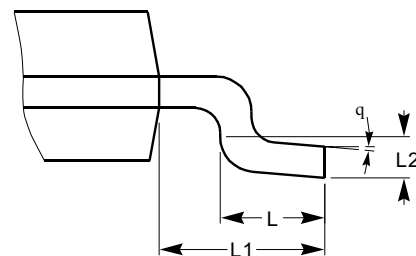

DETAIL A

Notes:

- (1) All dimensions are in millimeters. Angles in degrees.
- (2) Complies with JEDEC MO-187.



3W Filterless Mono Class-D Audio Power Amplifier

Package Information

DFN 2X2_8L

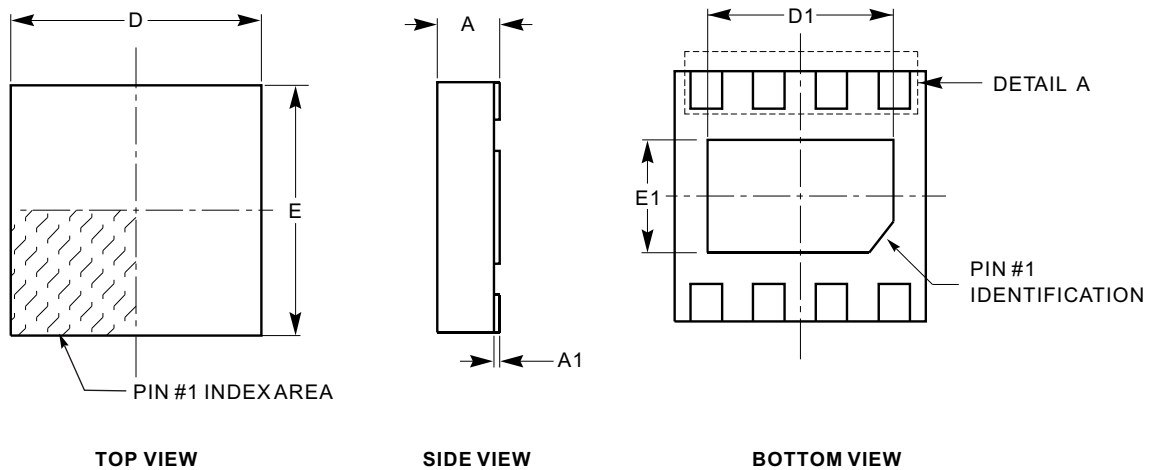

SYMBOL	MIN	NOM	MAX
A	0.70	0.75	0.80
A1	0.00	0.02	0.05
b	0.18	0.25	0.30
D	2.00BSC		
D1	1.10	1.20	1.30
E	2.00BSC		
E1	0.50	0.60	0.70
e	0.50 BSC		
L	0.20	0.30	0.40

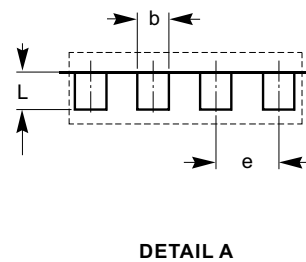

Notes:

- (1) All dimensions are in millimeters.
- (2) Complies with JEDEC MO-229.