

ISL97635A

SMBus 6-Channel LED Driver

FN6564
Rev.3.00
Sep 26, 2017

The [ISL97635A](#) is a digitally controlled LED driver that controls 6 channels of LED current for LCD backlight applications. The ISL97635A is capable of driving typically 54 (6x9) pieces of 3.5V/30mA or 60 (6x10) pieces of 3.2V/20mA LEDs. The ISL97635A contains 6 channels of voltage controlled current sources with typical currents matching of $\pm 1\%$, which compensate for the non-uniformity effect of forward voltages variance in the LED stacks. To minimize the voltage headroom and power loss in the typical multi-strings operation, the ISL97635A features a dynamic headroom control that monitors the highest LED forward voltage string and uses its feedback signal for output regulation.

The LED dimming control can be achieved through a SMBus, an external PWM, or a variable DC (analog light sensor) input. SMBus controlled dimming allows 256 levels each of PWM and DC current adjustments. The SMBus PWM dimming frequency can be adjusted from 100Hz to 5kHz by an external capacitor. External PWM input allows up to 20kHz audio noise free PWM dimming. The SMBus PWM setting and an external PWMI signal can also be combined to provide a dynamic PWM dimming that complies with Intel's DPST (Display Power Saving Technology) requirement.

One or more channels can be selected sequentially in any order allowing scrolling in RGB LED backlighting applications.

The ISL97635A features extensive protection functions that include string open and short-circuit detections, OVP, OTP, thermal shutdown, and an optional input overcurrent protection with master fault disconnect switch. The fault conditions will be recorded in the Fault/Status register. There are selectable short-circuit thresholds and the switching frequency can be programmed between 600kHz and 1.2MHz.

Available in the 24 Ld 4mmx4mm QFN, the ISL97635A operates from -40°C to $+85^{\circ}\text{C}$ with input voltage ranging from 6V to 24V for high LEDs count applications.

Related Literature

- For a full list of related documents, visit our website
 - [ISL97635A](#) product page

Features

- 6 channels
- 6V to 24V input
- 34.5V output maximum
- Drive maximally 54 (3.5V/30mA each) or 60 (3.2V/20mA each) LEDs
- Current matching $\pm 1\%$ typical
- Dynamic headroom control
- Dimming controls
 - SMBus 8-bit PWM current control
 - SMBus 8-bit DC current control
 - External PWM input up to 20kHz dimming
 - SMBus and external PWM DPST dimming control
 - DC-to-PWM dimming control
- Protections
 - String open circuit detection
 - String short-circuit detection with selectable thresholds
 - Over-temperature protection
 - Overvoltage protection
 - Input overcurrent protection with disconnect switch
- 600kHz/1.2MHz selectable f_{SW}
- Selectable channels allows scrolling backlight
- 24 Ld (4mmx4mm) QFN package
- Pb-free (RoHS compliant)

Applications

- Notebook displays WLED or RGB LED backlighting
- LCD monitor LED backlighting
- Automotive displays LED backlighting
- Automotive or traffic lighting

Ordering Information

PART NUMBER (Note)	PART MARKING	PACKAGE (RoHS COMPLIANT)	PKG. DWG. #
ISL97635AIRZ	976 35AIRZ	24 Ld 4x4 QFN	L24.4x4D

NOTES:

1. Add “-T” suffix for 6k unit or “-TK” suffix for 1k unit tape and reel options. Refer to [TB347](#) for details on reel specifications.
2. These Intersil Pb-free plastic packaged products employ special Pb-free material sets, molding compounds/die attach materials, and 100% matte tin plate plus anneal (e3 termination finish, which is RoHS compliant and compatible with both SnPb and Pb-free soldering operations). Intersil Pb-free products are MSL classified at Pb-free peak reflow temperatures that meet or exceed the Pb-free requirements of IPC/JEDEC J STD-020.
3. For Moisture Sensitivity Level (MSL), see product information page for [ISL97635A](#). For more information on MSL, see tech brief [TB363](#).

Typical Application Circuit

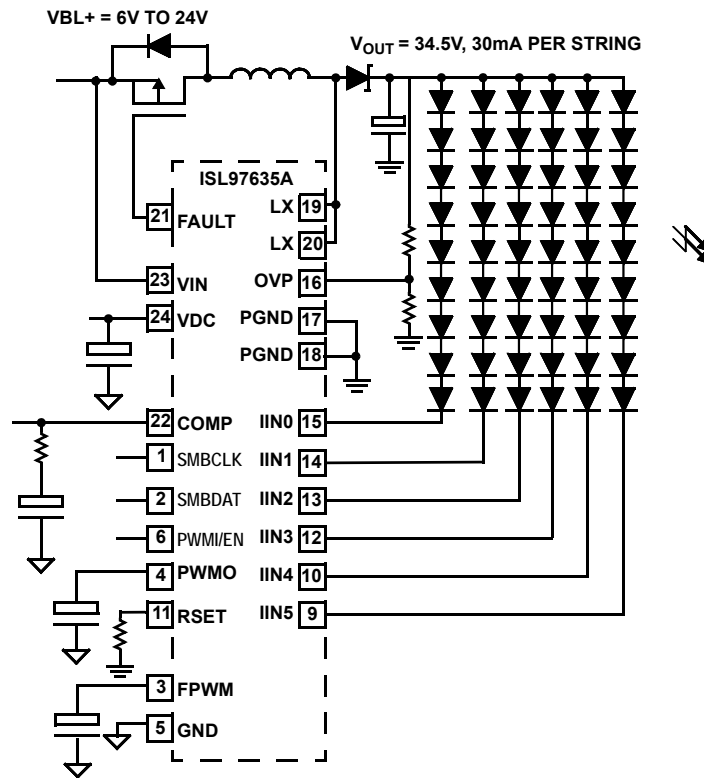

FIGURE 1. Typical Application Circuit

Block Diagram

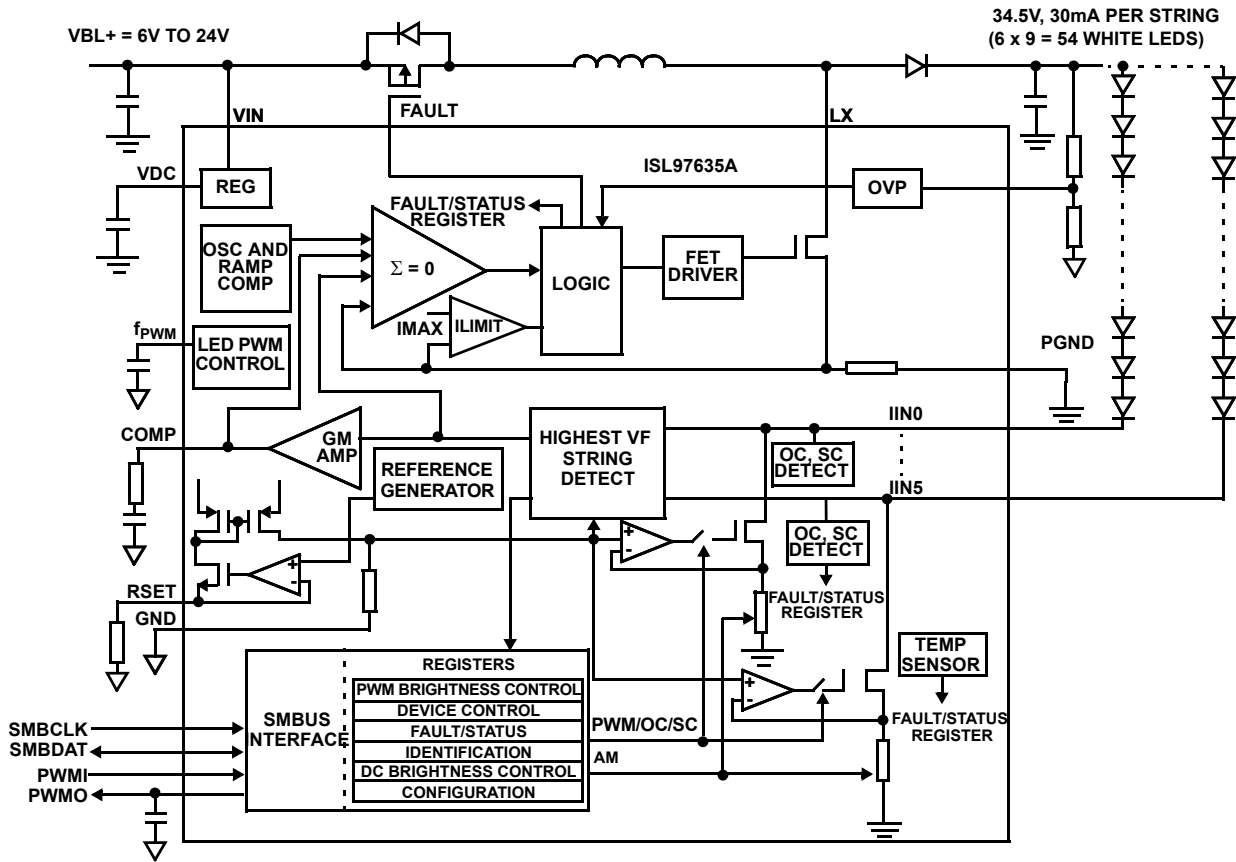
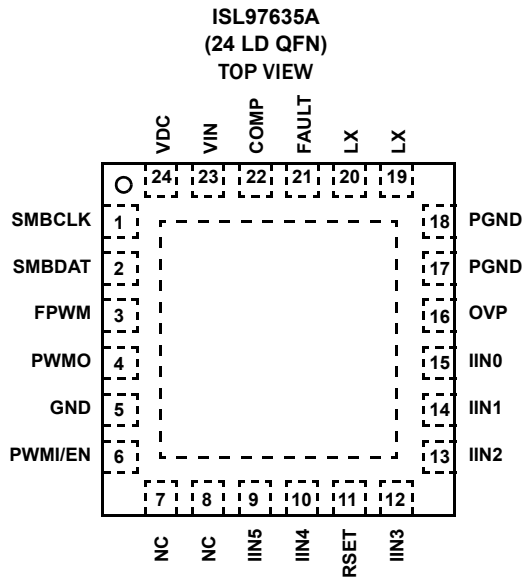

FIGURE 2. ISL97635A BLOCK DIAGRAM

Pin Configuration



Pin Descriptions (I = Input, O = Output, S = Supply)

PIN	NAME	TYPE	DESCRIPTION
1	SMBCLK	I	SMBus serial clock input
2	SMBDAT	I/O	SMBus serial data input and output
3	FPWM	I	Connect a capacitor between FPWM and GND to set the DPWM frequency. $FPWM = 5.4\mu / C_{FPWM}$ If SMBus PWM or DPST mode is used, connect C_{FPWM} to GND to set the dimming frequency. Also, connect C_{PWMO} between V_{PWMO} and GND pins for DPST operation. If DC-to-PWM mode is used, connect C_{FPWM} to set the dimming frequency and apply a 0.21V to 1.21V at V_{PWMO} .
4	PWMO	I/O	PWMI buffered output. If one connects a capacitor between PWMO and GND, it forms a lowpass filter with an internal 40k Ω resistor to filter the PWMI signal for DPST operation when Reg 0x01 = 0x01. If one applies a 0.2V to 1.2V DC input voltage, the output will be PWM with duty cycle proportional to the DC input.
5	GND	S	Analog GND and LED power return
6	PWMI/EN	I	Dual Functions: Enable Pin and PWM brightness control pin or DPST control input. DO NOT let PWMI/EN floating. The device needs 4ms for initial power-up Enable, then this pin can be applied with a PWM signal with off time no longer than 28ms.
7, 8	NC	-	No Connect. Can be floating or grounded
9	IIN5	I	Input 5 to current source, FB, and monitoring
10	IIN4	I	Input 4 to current source, FB, and monitoring
11	RSET	I	Resistor connection for setting LED current, (see Equation 1 for calculating the ILEDmax)
12	IIN3	I	Input 3 to current source, FB, and monitoring
13	IIN2	I	Input 2 to current source, FB, and monitoring
14	IIN1	I	Input 1 to current source, FB, and monitoring
15	IINO	I	Input 0 to current source, FB, and monitoring
16	OVP	I	Overvoltage protection input
17, 18	PGND	S	Power ground (LX Power return)
19, 20	LX	I	Input to boost switch
21	FAULT	O	Fault disconnect switch
22	COMP	O	Boost compensation pin
23	VIN	S	Input voltage for the device and LED power
24	VDC	S	De-couple capacitor for internally generated supply rail. If $2.7V < V_{BL+} < 5.5V$, apply VDC directly with a supply voltage of 2.7V to 5.5V

Absolute Maximum Ratings ($T_A = +25^\circ\text{C}$)

VIN, FAULT	-0.3V to 24V
VDC, COMP, RSET	-0.3V to 6.5V
SMBCLK, SMBDAT, FPWM, PWMO, EN/PWM	-0.3V to 6.5V
OVP, IIN0 - IIN5	-0.3V to 28V
LX	-0.3V to 36V
PGND	-0.3V to +0.3V

Above voltage ratings are all with respect to GND pin

Thermal Information

Thermal Resistance (Typical, Notes 1, 2)	θ_{JA} ($^\circ\text{C}/\text{W}$)	θ_{JC} ($^\circ\text{C}/\text{W}$)
24 Ld QFN	39	2
Thermal Characterization (Typical, Note 3)		PSI _{JT} ($^\circ\text{C}/\text{W}$)
24 Ld QFN		~0.7
Maximum Continuous Junction Temperature	+125 $^\circ\text{C}$	
Storage Temperature	-65 $^\circ\text{C}$ to +150 $^\circ\text{C}$	
Pb-free Reflow Profile	see TB493	

Operating Conditions

Temperature Range-40 $^\circ\text{C}$ to +85 $^\circ\text{C}$

IMPORTANT NOTE: All parameters having Min/Max specifications are guaranteed. Typical values are for information purposes only. Unless otherwise noted, all tests are at the specified temperature and are pulsed tests, therefore: $T_J = T_C = T_A$

CAUTION: Do not operate at or near the maximum ratings listed for extended periods of time. Exposure to such conditions may adversely impact product reliability and result in failures not covered by warranty.

NOTES:

- θ_{JA} is measured in free air with the component mounted on a high-effective thermal conductivity test board with "direct attach" features. Refer to [TB379](#).
- For θ_{JC} , the "case temp" location is the center of the exposed metal pad on the package underside assumed under ideal case temperature.
- PSI_{JT} is the junction-to-top thermal resistance. If the package top temperature can be measured, with this rating then the die junction temperature can be estimated more accurately than the θ_{JC} and θ_{JA} thermal resistance ratings.

Electrical Specifications

All specifications below are tested at $T_A = -40^\circ\text{C}$ to +85 $^\circ\text{C}$; $V_{IN} = 12\text{V}$, $EN = 5\text{V}$, $R_{SET} = 36.6\text{k}\Omega$, unless otherwise noted. Parameters with MIN and/or MAX limits are 100% tested at +25 $^\circ\text{C}$, unless otherwise specified. Temperature limits established by characterization and are not production tested.

PARAMETER	SYMBOL	CONDITION	MIN	TYP	MAX	UNIT
GENERAL						
Backlight Supply Voltage	VIN	≤ 9 LEDs per channel (3.5V/30mA type)	6		24	V
VIN Shutdown Current	IVIN_STBY				5	μA
Output Voltage	V _{OUT}				34.5	V
Undervoltage Lockout Threshold	V _{UVLO}		2.45		2.8	V
Undervoltage Lockout Hysteresis	V _{UVLO_HYS}			300		mV
REGULATOR						
LDO Output Voltage	V _{DC}	V _{IN} > 6V	5.0		5.5	V
Standby Current	I _{VDC_STBY}	EN/PWM = 0V			20	μA
Active Current	I _{VDC}	EN/PWM = 5V		10		mA
VDC LDO Dropout Voltage	V _{LDO}	V _{IN} > 5.5V, 30mA		30	200	mV
Soft-Start	SS			1		ms
Minimum Enable Signal	ENmin			40		μs
BOOST						
Boost FET Current Limit	SWILimit	T _A = +25 $^\circ\text{C}$	2.3		3.2	A
		T _A = -40 $^\circ\text{C}$ to +85 $^\circ\text{C}$	2.2			A
Internal Boost Switch ON-Resistance	r _{DS(ON)}			130	260	mΩ
Peak Efficiency	Eff _{peak}	V _{IN} = 18V, 54 LEDs, 20mA each, L = 8.2μH with DCR 106mΩ, T _A = +25 $^\circ\text{C}$		91		%
		V _{IN} = 12V, 54 LEDs, 20mA each, L = 8.2μH with DCR 106mΩ, T _A = +25 $^\circ\text{C}$		88		%
		V _{IN} = 6V, 54 LEDs, 20mA each, L = 8.2μH with DCR 106mΩ, T _A = +25 $^\circ\text{C}$		86		%

Electrical Specifications All specifications below are tested at $T_A = -40^\circ\text{C}$ to $+85^\circ\text{C}$; $V_{IN} = 12\text{V}$, $EN = 5\text{V}$, $R_{SET} = 36.6\text{k}\Omega$, unless otherwise noted. Parameters with MIN and/or MAX limits are 100% tested at $+25^\circ\text{C}$, unless otherwise specified. Temperature limits established by characterization and are not production tested. **(Continued)**

PARAMETER	SYMBOL	CONDITION	MIN	TYP	MAX	UNIT
Line Regulation	$\Delta I_{OUT}/\Delta V_{IN}$			0.1		%
Boost Maximum Duty Cycle	D_{max}		82			%
Boost Minimum Duty Cycle	D_{min}			7		%
LX Frequency	F_{OSC_hi}	Register 0x08, $f_{SW} = 1$	1.0	1.2	1.3	MHz
LX Frequency	F_{OSC_lo}	Register 0x08, $f_{SW} = 0$	550	600	650	kHz
LX Leakage Current	ILX_leakage	VLX = 36V, EN = 0			10	μA
REFERENCE						
Channel-to-Channel Current Matching	I_{MATCH}	$I_{OUT} = 30\text{mA}$, BRT = 255	-3.5	± 1	+3.5	%
Current Accuracy	I_{ACC}			± 3		%
FAULT DETECTION						
Short-Circuit Threshold	V_{SC}	Reg0x08 = 0x0F or 0x0B Reg0x00 = 0xFF	7.8	8	8.8	V
		Reg0x08 = 0x0E or 0x0A Reg0x00 = 0xFF	2.8	3.1	3.8	V
Over-Temperature Threshold Accuracy	V_{temp_acc}			5		$^\circ\text{C}$
Overvoltage Limit on OVP Pin	V_{OVPIo}		1.17	1.2	1.23	V
OVP Hysteresis	OVP_{hys}			20		mV
OVP Short Detection Fault Level	OVP_{fault}			300		mV
SMBus INTERFACE						
Guaranteed Range for Data, Clock Input Low Voltage	V_{IL}				0.8	V
Guaranteed Range for Data, Clock Input High Voltage	V_{IH}		2.1		VDD	V
SMBus Data Line Logic Low Voltage with 1.1k Ω Series Resistor from Data Bus to SMBDAT pin	V_{OL}	$I_{PULLUP} = 350\mu\text{A}$			0.4	V
SMBus Data Line Logic Low Voltage without Series Resistor from Data Bus to SMBDAT Pin		$I_{PULLUP} = 4\text{mA}$			0.17	V
Input Leakage on SMBData/SMBClk	I_{LEAK}		-1		1	μA
Nominal Bus Voltage	V_{DD}	3V to 5V $\pm 10\%$	2.7		5.5	V
SMBus TIMING SPECIFICATIONS (Note 4)						
SMBus Clock Frequency	f_{SMB}		10		100	kHz
Bus Free Time between STOP and START Condition	t_{BUF}		4.7			μs
Hold Time after (Repeated) START Condition. After this Period, the First Clock is Generated.	$t_{HD:STA}$		4.0			μs
Repeated Start Condition Setup Time	$t_{SU:STA}$		4.7			μs
Stop Condition Setup Time	$t_{SU:STO}$		4.0			μs
Data Hold Time	$t_{HD:DAT}$		300			$v\sigma$
Data Setup Time	$t_{SU:DAT}$		250			ns
Clock Low Period	t_{LOW}		4.7			μs
Clock High Period	t_{HIGH}		4.0		50	μs
Clock/Data Fall Time	t_F				300	ns
Clock/Data Rise Time	t_R				1000	ns

Electrical Specifications All specifications below are tested at $T_A = -40^\circ\text{C}$ to $+85^\circ\text{C}$; $V_{IN} = 12\text{V}$, $EN = 5\text{V}$, $R_{SET} = 36.6\text{k}\Omega$, unless otherwise noted. Parameters with MIN and/or MAX limits are 100% tested at $+25^\circ\text{C}$, unless otherwise specified. Temperature limits established by characterization and are not production tested. **(Continued)**

PARAMETER	SYMBOL	CONDITION	MIN	TYP	MAX	UNIT
GENERAL TIMING SPECIFICATIONS (Note 4)						
Minimum Setup Time Between V_{IN} Rising above VUVLO with $EN = 1$ and SMBus Communications	t_1	$EN = 1, T_A = +25^\circ\text{C}$, VDC capacitor $< 10\mu\text{F}$		80		μs
Minimum Setup Time Between EN Going High with V_{IN} above VUVLO and SMBus Communications	t_2	$V_{IN} > \text{VUVLO}$, $T_A = +25^\circ\text{C}$, VDC capacitor $< 10\mu\text{F}$		80		μs
Minimum Time Between V_{IN} Rising above VUVLO with $EN = 1$ to SMBus BL CTRL On	t_3	$EN = 1, T_A = +25^\circ\text{C}$		4.5		ms
Minimum Time Between EN Going High with V_{IN} above VUVLO to SMBus BL CTRL On	t_4	$V_{IN} > \text{VUVLO}$, $T_A = +25^\circ\text{C}$		4.5		ms
Minimum Time for LED Output to Respond to SMBus Data at any Levels	t_5	$V_{IN} > \text{VUVLO}$, $EN = 1, T_A = +25^\circ\text{C}$		5		μs
Response Time Between Backlight CTRL Off with Boost Not Switching to Backlight CTRL On with Boost Switching	t_6	$V_{IN} > \text{VUVLO}$, $EN = 1, T_A = +25^\circ\text{C}$		5		μs
Response Time Between Backlight CTRL On with Boost Switching to Backlight CTRL Off with Boost Not Switching	t_7	$V_{IN} > \text{VUVLO}$, $EN = 1, T_A = +25^\circ\text{C}$		5		μs
LED Channel Short-Circuit Fault Detection to Status Register Data Ready	t_8	$V_{IN} > \text{VUVLO}$, $EN = 1, T_A = +25^\circ\text{C}$, LEDs Active		6		ms
$V_{OUT-GND}$ Short-Circuit Detection During Operation to Status Register Data Ready	t_9	$V_{IN} > \text{VUVLO}$, $EN = 1, T_A = +25^\circ\text{C}$, Fault FET used		5		μs
Time Between V_{IN} Rising Above VUVLO with $EN = 1$ and $V_{OUT-GND}$ Short being Reported in Status Register	t_{10}	$EN = 1$, VDC capacitor $< 10\mu\text{F}$, $T_A = +25^\circ\text{C}$, Fault FET used.		30		ms
Time Between EN Going High with V_{IN} Above VUVLO and a $V_{OUT-GND}$ Short being Reported in Status Register	t_{11}	$V_{IN} > \text{VUVLO}$, VDC capacitor $< 10\mu\text{F}$, $T_A = +25^\circ\text{C}$, Fault FET used.		30		ms
CURRENT SOURCES						
Dominant Channel Current Source Headroom at IIN Pin	V_{HEADROOM}	$I_{\text{LED}} = 20\text{mA}$, $T_A = +25^\circ\text{C}$		100 (Note 5)		mV
Dominant Channel Current Sink Headroom Range at IIN Pin	$V_{\text{HEADROOM_RANGE}}$	$I_{\text{LED}} = 20\text{mA}$, $T_A = +25^\circ\text{C}$		10		mV
Voltage at RSET Pin	V_{RSET}	$R_{\text{SET}} = 36.6\text{k}\Omega$	680	700	720	mV
Maximum LED Current Per Channel	I_{LEDmax}	$R_{\text{SET}} = 20.9\text{k}\Omega$		35		mA
PWM GENERATOR (Note 4)						
Generated PWM Frequency	FPWM	$C_{\text{FPWM}} = 27\text{nF}$, $C_{\text{PWMO}} = 220\text{nF}$		200		Hz
Duty Cycle of Generated PWM (DC-to-PWM)	DPWM	$V_{\text{PWMO}} = 0.3\text{V}$ $C_{\text{FPWM}} = 27\text{nF}$		90		%
		$V_{\text{PWMO}} = 1.1\text{V}$ $C_{\text{FPWM}} = 27\text{nF}$		10		%
Maximum PWM Off-Time Before Shutdown	$t_{\text{MAX_PWM_OFF}}$	EN/PWMI toggles		28		ms

Electrical Specifications All specifications below are tested at $T_A = -40^\circ\text{C}$ to $+85^\circ\text{C}$; $V_{IN} = 12\text{V}$, $EN = 5\text{V}$, $R_{SET} = 36.6\text{k}\Omega$, unless otherwise noted. Parameters with MIN and/or MAX limits are 100% tested at $+25^\circ\text{C}$, unless otherwise specified. Temperature limits established by characterization and are not production tested. **(Continued)**

PARAMETER	SYMBOL	CONDITION	MIN	TYP	MAX	UNIT
FAULT PIN						
Fault Pull-Down Current	I_{FAULT}	$V_{IN} = 12\text{V}$	10	18	30	μA
FAULT Clamp Voltage With Respect to V_{IN}	V_{FAULT}	$V_{IN} = 12, V_{IN} - V_{FAULT}$		7.5		V
LX Start-Up Current	$I_{LXStart-up}$	$V_{DC} = 5.2\text{V}$	1	2.7	7	mA

NOTES:

- Limits established by characterization and are not production tested.
- Varies within range specified by $V_{HEADROOM_RANGE}$.

Typical Performance Curves

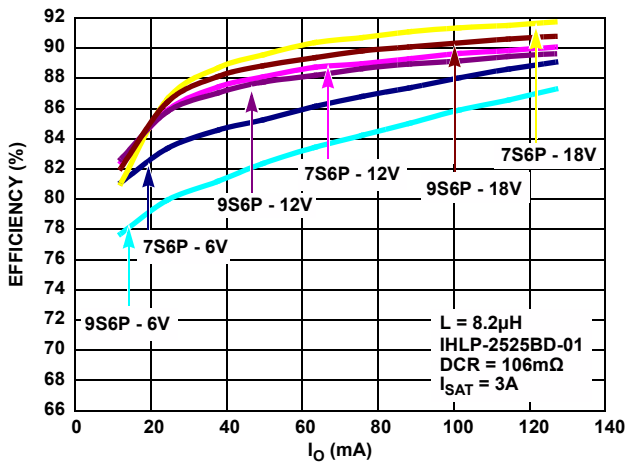

FIGURE 3. EFFICIENCY, $L = 8.2\mu\text{H}$ WITH $\text{DCR} = 106\text{m}\Omega$, $C_0 = 4 \times 4.7\mu\text{F}/50\text{V}$

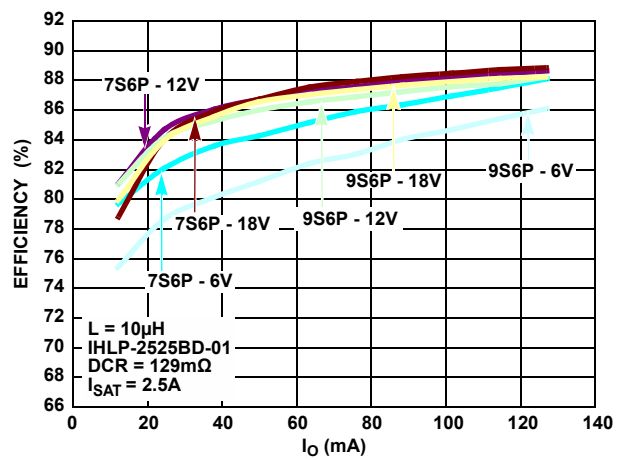

FIGURE 4. EFFICIENCY, $L = 10\mu\text{H}$ WITH $\text{DCR} = 129\text{m}\Omega$, $C_0 = 4 \times 4.7\mu\text{F}/50\text{V}$

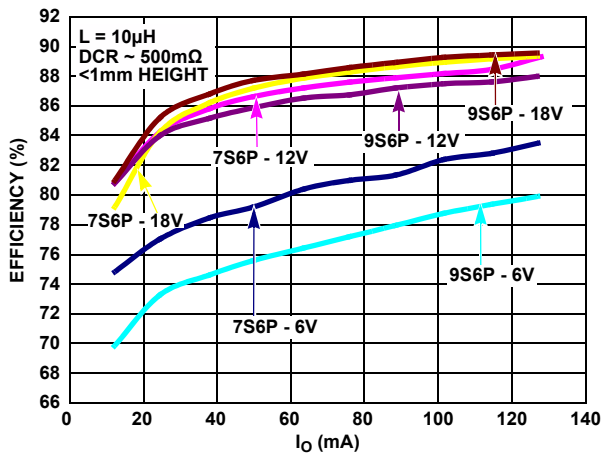

FIGURE 5. 3 EFFICIENCY, $L = 10\mu\text{H}$ WITH $\text{DCR} = 500\text{m}\Omega$, 1mm, $C_0 = 4 \times 4.7\mu\text{F}/50\text{V}$

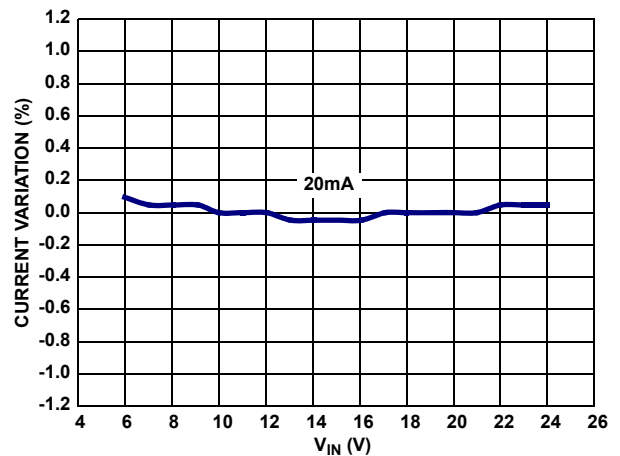

FIGURE 6. CURRENT REGULATION

Typical Performance Curves (Continued)

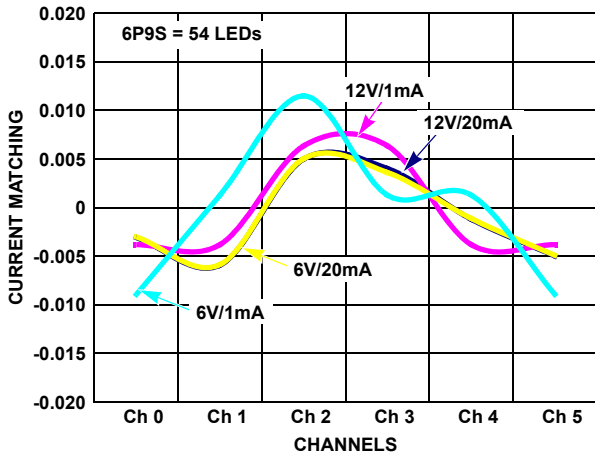

FIGURE 7. CHANNEL-TO-CHANNEL CURRENT MATCHING

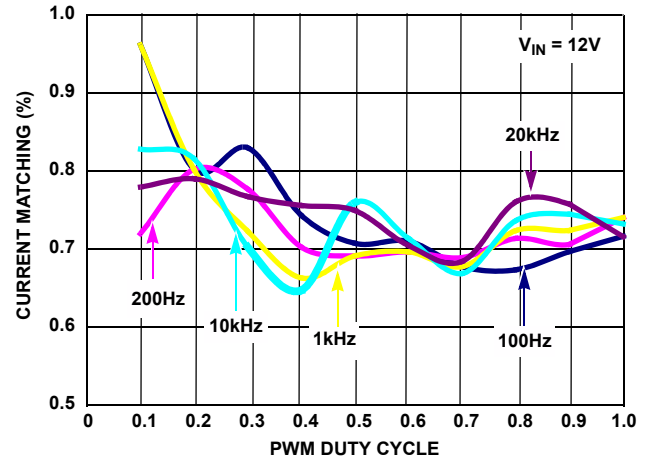

FIGURE 8. CURRENT MATCHING vs DUTY CYCLE vs DIMMING FREQUENCY

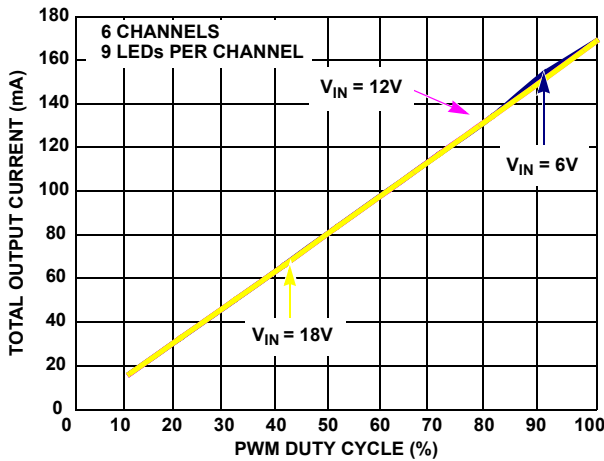

FIGURE 9. PWM DIMMING LINEARITY

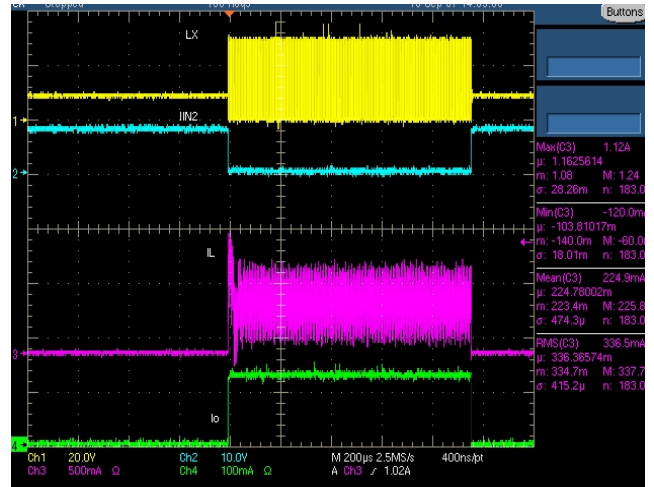

FIGURE 10. LX, IIN, IL AND LO

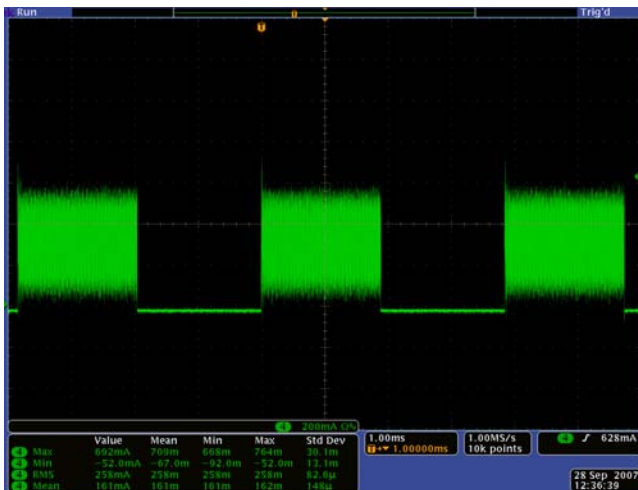

FIGURE 11. I_L AT 50% PWM DIMMING

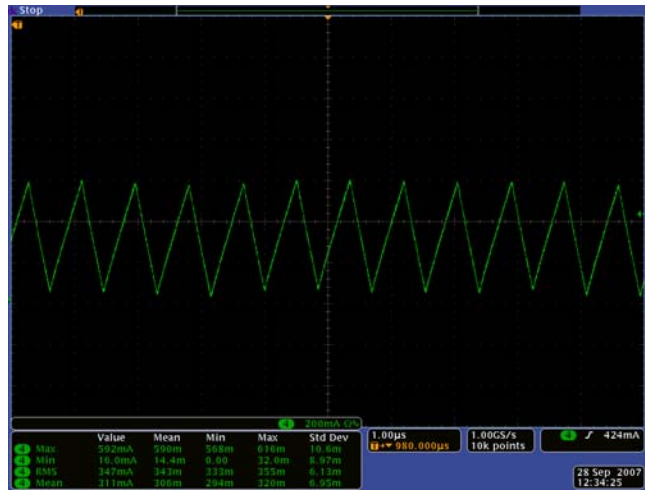

FIGURE 12. I_L ZOOM IN AT PWM DIMMING ZOOM IN

Typical Performance Curves (Continued)



FIGURE 13. I_{LED} AT 50% PWM DIMMING

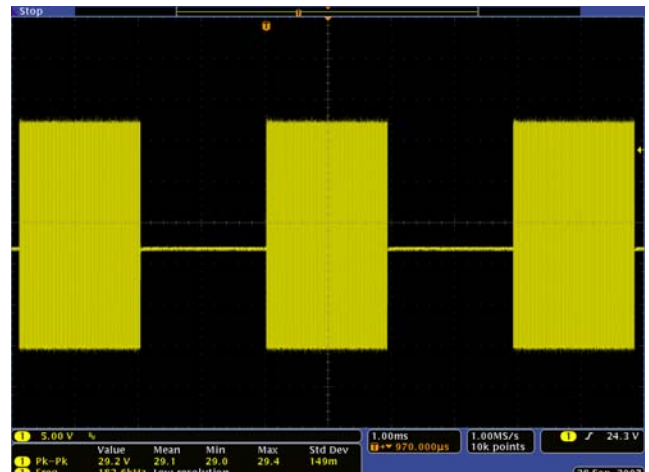

FIGURE 14. LX AT 50% PWM DIMMING

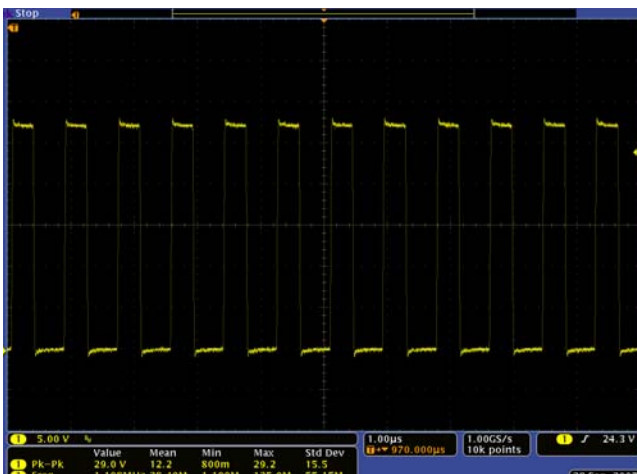

FIGURE 15. LX ZOOM IN AT 50% DIMMING

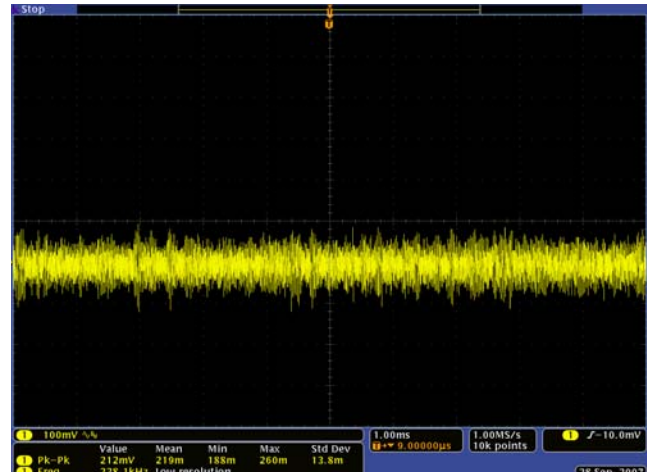

FIGURE 16. RIPPLE VOLTAGE

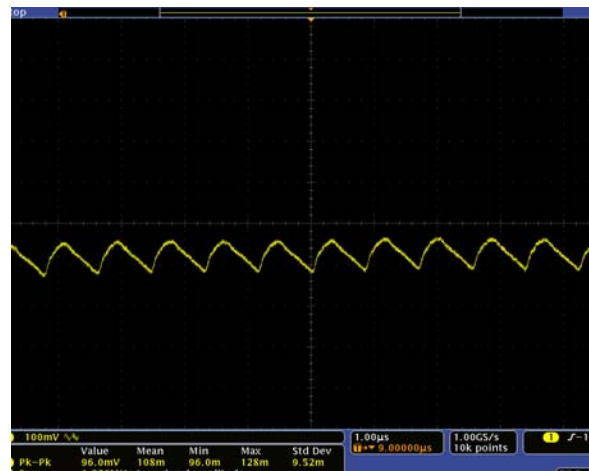

FIGURE 17. RIPPLE VOLTAGE ZOOM IN

Theory of Operation

PWM Boost Converter

The current mode PWM boost converter produces the minimal voltage needed to enable the LED stack with the highest forward voltage drop to run at the programmed current. The ISL97635A employs current mode control boost architecture that has a fast current sense loop and a slow voltage feedback loop. Such architecture achieves a fast transient response that is essential for the notebook backlight applications where the power can be a series of drained batteries or instantly changed to an AC/DC adapter without rendering a noticeable visual nuisance. The number of LEDs that can be driven by ISL97635A depends on the type of LED chosen in the application. The ISL97635A is capable of boosting up to 34.5V and typically driving 9 LEDs in series for each of the 6 channels, enabling a total of 54 pieces of the 3.5V/30mA type of LEDs.

Enable and PWMI

The EN/PWMI pin serves dual purposes; it is used as an enable signal and can be used for PWM input signal for dimming. If a PWM signal is applied to this pin, the first pulse of minimum 40µs will be used as an Enable signal. If there is no signal for longer than 28ms, the device will enter shutdown. The EN/PWMI pin cannot be floating, thus, a 10kΩ pull-down resistor may need to be added.

Current Matching and Current Accuracy

Each channel of the LED current is regulated by the current source circuit, as shown in [Figure 18](#).

The LED peak current is set by translating the R_{SET} current to the output with a scaling factor of $733/R_{SET}$. The source terminals of the current source MOSFETs are designed to operate within a range at about 100mV to minimize the power loss. The sources of errors of the channel-to-channel current matching come from the op amp's offset, internal layout, reference, and current source resistors. These parameters are optimized for current matching and absolute current accuracy. On the other hand, the absolute accuracy is additionally determined by the external R_{SET} , and therefore, additional tolerance will be contributed by the current setting resistor. A 1% tolerance resistor is therefore recommended.

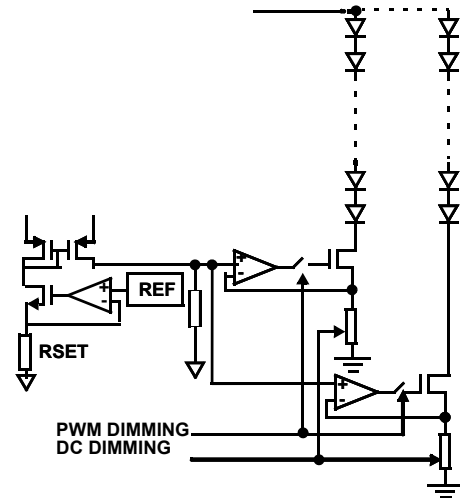

FIGURE 18. SIMPLIFIED CURRENT SOURCE CIRCUIT

Dynamic Headroom Control

The ISL97635A features a proprietary Dynamic Headroom Control circuit that detects the highest forward voltage string or effectively the lowest voltage from any of the IIN pins. When this lowest I_{IN} voltage is lower than the short-circuit threshold, V_{SC} , such voltage will be used as the feedback signal for the boost regulator. The boost makes the output to the correct level such that the lowest IIN pin is at the target headroom voltage. Since all LED stacks are connected to the same output voltage, the other IIN pins will have a higher voltage, but the regulated current source circuit on each channel will ensure that each channel has the same programmed current. The output voltage will regulate cycle by cycle and it is always referenced to the highest forward voltage string in the architecture.

Dimming Controls

The ISL97635A allows two ways of controlling the LED current, and therefore, the brightness. They are:

1. DC current adjustment.
2. PWM chopping of the LED current defined in Step 1.

There are various ways to achieve DC or PWM current control, which will be described in the following.

MAXIMUM DC CURRENT SETTING

The initial brightness should be set by choosing an appropriate value for R_{SET} . This should be chosen to fix the maximum possible LED current, as shown in [Equation 1](#):

$$I_{LEDmax} = \frac{733}{R_{SET}} \quad (\text{EQ. 1})$$

DC CURRENT ADJUSTMENT

Once R_{SET} is fixed, the LED DC current can be adjusted through register 0x07 (BRTDC), as shown in [Equation 2](#):

$$I_{LED} = 2.87 \times \text{BRTDC} / R_{SET} \quad (\text{EQ. 2})$$

BRTDC can be programmed from 0 to 255 in decimal and defaults to 255 (0xFF). If left at the default value, LED current will

be fixed at I_{LEDmax} . BRTDC can be adjusted dynamically on the fly during operation. BRTDC = 0 disconnects all channels and ILED is guaranteed to be <10 μ A at this state.

For example, if the maximum required LED current (I_{LEDmax}) is 20mA, rearranging [Equation 1](#) yields [Equation 3](#):

$$R_{SET} = 733/0.02 = 36.6k\Omega \quad (EQ. 3)$$

If BRTDC is set to 200, then:

$$I_{LED} = 2.87*200/36600 = 15.7mA \quad (EQ. 4)$$

PWM CONTROL

The ISL97635A provides four different PWM dimming methods, as described in the following. Each of these methods results in PWM chopping of the current in the LEDs for all 6 channels to provide an average LED current. During the on-periods, the LED current will be defined by the value of R_{SET} and BRTDC, as described in [Equations 1](#) and [2](#). The source of the PWM signal can be described as follows:

1. **Internally generated** 256 step duty cycle programmed through the SMBus.
2. **External** signal from PWMI.
3. **DPST mode.** Internally generated signal with a duty cycle defined by the product of the external PWMI and SMBus programmed PWM at the internal setting frequency.
4. **DC-to-PWM** control.

The default PWM dimming is in DPST mode. In all four methods, the average LED current of each channel is controlled by I_{LED} and the PWM duty cycle in percent as shown in [Equation 5](#):

$$I_{LED(ave)} = I_{LED} \times PWM \quad (EQ. 5)$$

Method 1 (Internal Mode, SMBus controlled PWM)

The average LED current of each channel is controlled by the internally generated PWM signal as shown in [Equation 6](#):

$$I_{LED(ave)} = I_{LED} \times (BRT/255) \quad (EQ. 6)$$

where BRT is the PWM brightness level programmed in the register 0x00. BRT ranges from 0 to 255 in decimal and defaults to 255 (0xFF). BRT = 0 disconnects all channels and I_{LED} is guaranteed to be <10 μ A in this state.

To use only the SMBus controlled PWM brightness control, users need to set Register 0x01 to 0x05 with EN/PWMI in logic high.

The SMBus controlled PWM frequency is adjusted by a capacitor at the FPWM pin, which will be described in [“PWM Dimming Frequency Adjustment \(Applicable to SMBus controlled PWM, DPST, and DC-to-PWM Modes\)”](#) on [page 13](#).

Method 2 (External Mode)

The average LED current of each channel can also be controlled by an external PWMI signal, as shown in [Equation 7](#):

$$I_{LED(ave)} = I_{LED} \times PWMI \quad (EQ. 7)$$

The PWM dimming frequency can be for example 20kHz but there are a minimum on and off time requirements such that the dimming will be in the range of 10% to 99.5%. If the dimming frequency is below 5kHz, the dimming range can be 1% to 99.5%.

The PWM dimming off time cannot be longer than 28ms or else the driver will enter shutdown.

To use PWMI only brightness control, users need to set Register 0x01 to 0x03.

Method 3 (DPST Mode)

The average LED current of each channel can also be controlled by the product of the SMBus controlled PWM and the external PWMI signals as follows:

$$I_{LED(ave)} = I_{LED} \times PWM_{DPST} \quad (EQ. 8)$$

where:

$$PWM_{DPST} = BRT/255 \times PWMI \quad (EQ. 9)$$

Therefore:

$$I_{LED(ave)} = I_{LED} \times BRT/255 \times PWMI \quad (EQ. 10)$$

Where BRT is the value held in register 0x00 (default setting 0xFF) controlled by SMBus and PWMI is the duty cycle of the incoming PWMI signal. In this way, the users can change the PWM current in ratiometric manner to achieve DPST compliance backlight dimming.

To use the DPST mode, users need to set register 0x01 to 0x01 with the external PWM signal.

The DPST mode PWM frequency is adjusted by a capacitor at the FPWM pin. Also, a C_{PWM0} capacitor is also needed, which will be described in [“PWM Dimming Frequency Adjustment \(Applicable to SMBus controlled PWM, DPST, and DC-to-PWM Modes\)”](#) on [page 13](#).

For example, if the SMBus controlled PWM duty is 80% dimming at 200Hz (see C_{FPWM} in [Equation 10](#)) and the external PWMI duty cycle is 60% dimming at 1kHz, the resultant PWM duty cycle is 48% dimming at 200Hz.

Method 4 (Analog Mode, DC-to-PWM Mode)

By overdriving the PWM0 pin with a DC voltage between 0.21V and 1.21V, the average LED current of each channel is controlled by the internally generated PWM signal as shown in [Equation 11](#):

$$I_{LED(ave)} = I_{LED} \times BRT/255 \times (1 - (V(PWM0) - 0.21)) \quad (EQ. 11)$$

Where BRT is the value held in register 0x00 (default setting 0xFF). The PWM0 pin is internally driven to 0.21V using a 40k Ω resistor when the PWMI/EN pin is in logic high, any overdrive circuit will need to be able to drive up to 40 μ A in order to overcome this.

The DC-to-PWM controlled PWM frequency is adjusted by a capacitor at the FPWM pin, which will be described in [“PWM Dimming Frequency Adjustment \(Applicable to SMBus controlled PWM, DPST, and DC-to-PWM Modes\)”](#) on [page 13](#).

For example, if PWM0 is applied with a DC voltage $\geq 1.21V$, the output will be zero. On the other hand, if the PWM0 is applied with a DC voltage $\leq 0.21V$, the PWM duty cycle will be at its maximum. If the PWM0 pin is applied with a DC voltage of $0.31V$, the PWM duty cycle will be at 90% at 200Hz if $C_{FPWM} = 27nF$.

PWM Dimming Frequency Adjustment (Applicable to SMBus controlled PWM, DPST, and DC-to-PWM Modes)

Except for the external PWM dimming mode where the frequency follows the external signal's, the dimming frequencies of the other modes are set by an external capacitor C_{FPWM} at the FPWM pin as shown in [Equation 12](#):

$$C_{FPWM} = 5.4\mu / F_{PWM} \quad (\text{EQ. 12})$$

where F_{PWM} is the desirable PWM dimming frequency.

For example, if $F_{PWM} = 200\text{Hz}$, $C_{FPWM} = 5.4\mu / 200 = 27nF$

The PWM dimming frequency can be for example 20kHz but there are a minimum on and off time requirements such that the dimming will be in the range of 10% to 99.5%. If the dimming frequency is below 5kHz, the dimming range can be 1% to 99.5%.

In the DPST and DC-to-PWM modes, a $C_{P_{WMO}}$ capacitor is also needed. An internal $40k\Omega$ and an external $C_{P_{WMO}}$ at the PWMO pin form a low pass network to filter the PWMI to an averaged DC. As a result, the time constant of the $40k\Omega$ and $C_{P_{WMO}}$ should be significantly larger than the external PWMI period, t , such that:

$$40k\Omega \times C_{P_{WMO}} > t \quad (\text{EQ. 13})$$

For example, if F_{PWM} is 200Hz and external PWMI is 1kHz or above, a $220nF$ $C_{P_{WMO}}$ can be chosen that allows the external PWMI signal to be filtered as an averaged DC. Also, the F_{PWM} frequency in the DPST mode should be limited between 100Hz to 2kHz and at least five times smaller than the external PWMI frequency when DPST mode is used.

Switching Frequency

An internal clock of 1.2MHz is used for the boost regulator control of the LX pin in default. There are 2 levels of switching frequencies: 600kHz or 1.2MHz. Each can be programmed in the Configuration Register 0x08 bit 2. The default switching frequency is at 1.2MHz.

5V Low Dropout Regulator

A 5.2V LDO regulator is present at the VDC pin to develop the necessary low voltage supply which is used by the chips internal control circuitry. Because VDC is an LDO pin, it requires a bypass capacitor of $1\mu F$ or more for the regulation. For applications with an input voltage $\leq 5.5V$, the VIN and VDC pins can be connected together. The VDC pin can be used as a coarse reference with few mA sourcing capability.

In-rush Control and Soft-start

The ISL97635A has separately built-in independent inrush control and soft-start functions. The inrush control function is

built around the short-circuit protection FET, and is only available in applications which include this device. At start-up, the fault protection FET is turned on slowly due to a $30\mu A$ pull-down current output from the FAULT pin. This discharges the fault FET's gate-source capacitance, turning on the FET in a controlled fashion. As this happens, the output capacitor is charged slowly through the weakly turned on FET before it becomes fully enhanced. This results in a low in-rush current. This current can be further reduced by adding a capacitor (in the 1nF to 5nF range) across the gate-source terminals of the FET.

Once the chip detects that the fault protection FET is turned on hard, it is assumed that inrush is complete. At this point, the boost regulator will begin to switch and the current in the inductor will ramp-up. The current in the boost power switch is monitored and the switching terminated in any cycle where the current exceeds the current limit. The ISL97635A includes a soft-start feature where this current limit starts at a low value (375mA). This is stepped up to the final 3A current limit in seven further steps of 375mA. These steps will happen over a 1ms total time, such that after 1ms the final limit will be reached. This allows the output capacitor to be charged to the required value at a low current limit and prevents high input current for systems that have only a low to medium output current requirement.

For systems with no master fault protection FET, the in-rush current will flow towards C_{OUT} when VIN is applied and it is determined by the ramp rate of VIN and the values of C_{OUT} and L.

Fault Protection and Monitoring

The ISL97635A features extensive protection functions to cover all the perceivable failure conditions. The failure mode of a LED can be either open circuit or as a short. The behavior of an open circuited LED can additionally take the form of either infinite resistance or, for some LEDs, a zener diode, which is integrated into the device in parallel with the now opened LED.

For basic LEDs (which do not have built-in zener diodes), an open circuit failure of an LED will only result in the loss of one channel of LEDs without affecting other channels. Similarly, a short-circuit condition on a channel that results in that channel being turned off does not affect other channels unless a similar fault is occurring. All LED faults are reported via the SMBus interface to register 0x02 (Fault/Status register). The controller is able to determine which channels have failed via register 0x09 (Output masking register). The controller can also choose to use register 0x09 to disable faulty channels at start-up, resulting in only further faulty channels being reported by register 0x02.

Due to the lag in boost response to any load change at its output, certain transient events (such as LED current steps or significant step changes in LED duty cycle) can transiently look like LED fault modes. The ISL97635A uses feedback from the LEDs to determine when it is in a stable operating region and prevents apparent faults during these transient events from allowing any of the LED stacks to fault out. See [Table 1](#) for more details.

A fault condition that results in an input current that exceeds the devices electrical limits will result in a shutdown of all output channels. The control device logic will remain functional such that the Fault/Status Register can be interrogated by the system. The root cause of the failure will be loaded to the volatile

Fault/Status Register so that the host processor can interrogate the data for failure monitoring.

Short-Circuit Protection (SCP)

The short-circuit detection circuit monitors the voltage on each channel and disables faulty channels which are detected above the programmed short-circuit threshold. There are two selectable levels of short-circuit threshold (3.1V and 8.0V) that can be programmed through the Configuration Register 0x08 Bit 0. When an LED becomes shorted, the action taken is described in [Table 1](#). The default short-circuit threshold is 8V. The detection of this failure mode can be disabled via register 0x08 bit 1 if required.

Open Circuit Protection (OCP)

When one of the LEDs becomes open circuit, it can behave as either an infinite resistance or a gradually increasing finite resistance. The ISL97635A monitors the current in each channel such that any string which reaches at least 75% of the intended output current is considered “good”. Should the current subsequently fall below 50% of the target, the channel will be considered an “open circuit”. Furthermore, should the boost output of the ISL97635A reach the OVP limit or should the lower over-temperature threshold be reached, all channels which are not “good” will immediately be considered as “open circuit”. Detection of an “open circuit” channel will result in a time-out before disabling of the affected channel. This time-out is sped up when the device is above the lower over-temperature threshold in an attempt to prevent the upper over-temperature trip point from being reached.

Some users employ some special types of LEDs that have zener diode structure in parallel with the LED for ESD enhancement and enabling open circuit operation. When this type of LED is open circuited, the effect is as if the LED forward voltage has increased but no lighting. Any affected string will not be disabled, unless the failure results in the boost OVP limit being reached, allowing all other LEDs in the string to remain functional. Care should be taken in this case that the boost OVP limit and SCP limit are set properly, so as to make sure that multiple failures on one string do not cause all other good channels to be faulted out. This is due to the increased forward voltage of the faulty channel making all other channels look as if they have LED shorts. See [Table 1](#) for details regarding responses to fault conditions.

Overvoltage Protection (OVP)

The integrated OVP circuit monitors the output voltage and keeps the voltage at a safe level. The OVP threshold is set as [Equation 14](#):

$$OVP = 1.21V \times (R_{UPPER} + R_{LOWER}) / R_{LOWER} \quad (EQ. 14)$$

These resistors should be large to minimize the power loss. For example, a 1M Ω R_{UPPER} and 39k Ω R_{LOWER} sets OVP to 32.2V. Large OVP resistors also allow C_{OUT} discharges slowly during the PWM off time.

Undervoltage Lockout

If the input voltage falls below the UVLO level of 2.45V, the device will stop switching and reset. Operation will restart when the voltage comes back into the operating range.

Input Overcurrent Protection

During normal switching operation, the current through the internal boost power FET is monitored. If the current exceeds the current limit, the internal switch will be turned off. This monitoring happens on a cycle-by-cycle basis in a self protecting way.

Additionally, the ISL97635A monitors the voltage at the LX and OVP pins. At start-up, a fixed current is injected out of the LX pins and into the output capacitor. The device will not start-up unless the voltage at LX exceeds 1.2V. Furthermore, should the voltage at LX not rise above this threshold during any subsequent period where the power FET is not switched on, it will immediately disable the input protection FET. The OVP pin is also monitored such that if it rises above and subsequently falls below 20% of the target OVP level, the input protection FET will also be switched off.

Over-Temperature Protection (OTP)

The ISL97635A includes two over-temperature thresholds. The lower threshold is set to +130 °C. When this threshold is reached, any channel which is outputting current at a level significantly below the regulation target will be treated as “open circuit” and disabled after a time-out period. This time-out period is also reduced to 800 μ s when it is above the lower threshold. The intention of the lower threshold is to allow bad channels to be isolated and disabled before they cause enough power dissipation (as a result of other channels having large voltages across them) to hit the upper temperature threshold.

The upper threshold is set to +150 °C. Each time this is reached, the boost will stop switching and the output current sources will be switched off. Once the device has cooled to approximately +100 °C, the device will restart with the DC LED current level reduced to 77% of the initial setting. If the dissipation problem persists, subsequent hitting of the limit will cause identical behavior, with the current reduced in steps to 53% and finally 30%. Hitting of the upper threshold will also set the thermal fault bit of the Fault/Status register 0x02. Unless disabled via the EN pin, the device stays in an active state throughout, allows the external processor to interrogate the fault condition.

For the extensive fault protection conditions, please refer to [Figure 19](#) and [Table 1](#) for details.

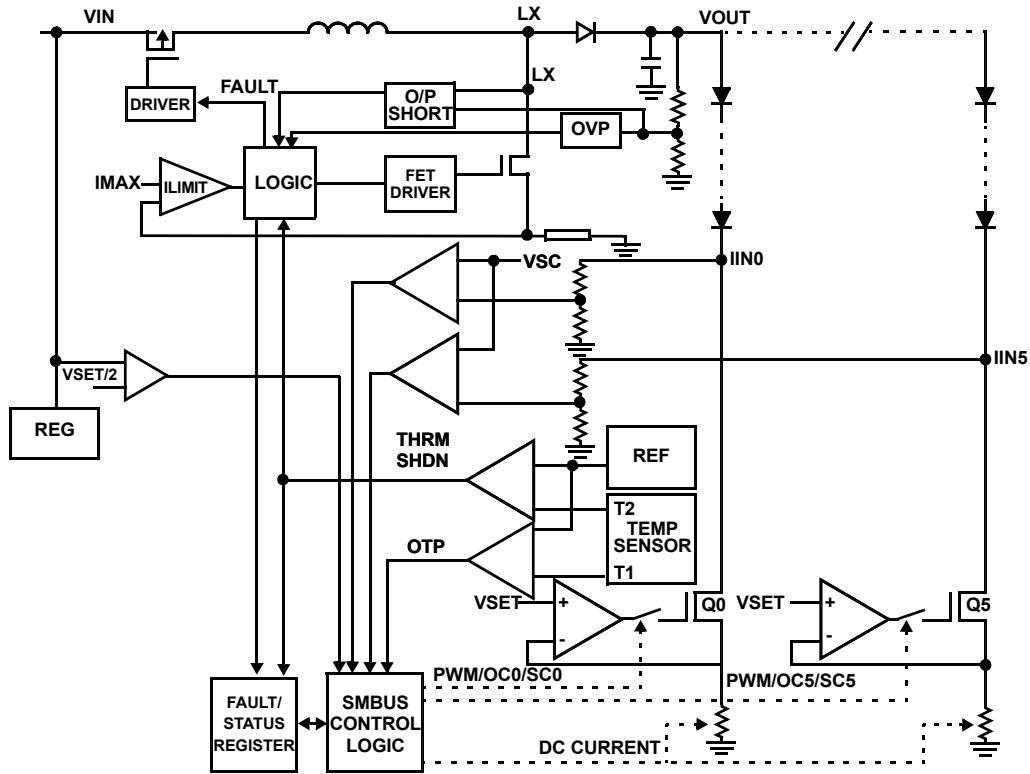

FIGURE 19. SIMPLIFIED FAULT PROTECTIONS

TABLE 1. PROTECTIONS TABLE

CASE	FAILURE MODE	DETECTION MODE	FAILED CHANNEL ACTION	GOOD CHANNELS ACTION	VOUT REGULATED BY
1	CH0 Short-Circuit	Upper Over-Temperature Protection limit (OTP) not triggered and VIINO < VSC	CH0 ON and burns power	CH1 through CH5 Normal	Highest VF of CH1 through CH5
2	CH0 Short-Circuit	Upper OTP triggered but VIINO < VSC	CH0 goes off until chip cooled and then comes back on with current reduced to 76%. Further OTP triggers result in reduction to 53%, then 30%. Thermal event reported in Fault/Status Register.	Same as CH0	Highest VF of CH1 through CH5
3	CH0 Short-Circuit	Upper OTP not triggered but VIINO > VSC	CH0 doubled after 6ms time-out. Time-out reduced to 420µs if above lower OTP limit	CH1 through CH5 Normal	Highest VF of CH1 through CH5
4	CH0 Open Circuit with infinite resistance	Upper OTP not triggered and VIINO < VSC	VOUT will ramp to OVP. CH0 will time-out after 6ms (800µs if above lower OTP limit) and switch off. VOUT will drop to normal level.	CH1 through CH5 Normal	Highest VF of CH1 through CH5
5	CH0 LED Open Circuit but has paralleled Zener	Upper OTP not triggered and VIINO < VSC	CH0 remains ON and has highest VF, thus VOUT increases	CH1 through CH5 ON, Q1 through Q5 burn power	VF of CH0

TABLE 1. PROTECTIONS TABLE (Continued)

CASE	FAILURE MODE	DETECTION MODE	FAILED CHANNEL ACTION	GOOD CHANNELS ACTION	VOUT REGULATED BY
6	CH0 LED Open Circuit but has paralleled Zener	Upper OTP triggered but VIINO < VSC	CH0 goes off until chip cooled and then comes back on with current reduced to 76%. Further OTP triggers result in reduction to 53%, then 30%. Thermal event reported in Fault/Status Register.	Same as CH0	VF of CH0
7	CH0 LED Open Circuit but has paralleled Zener	Upper OTP not triggered but VIINO > VSC	CH0 OFF	CH1 through CH5 Normal	Highest VF of CH1 through CH5
		Upper OTP not triggered but VIINx > VSC	CH0 remains ON and has highest VF, thus VOUT increases.	VOUT increases then CH-X switches OFF. This is an unwanted shut off and can be prevented by setting OVP and/or VSC at an appropriate level.	VF of CH0
8	Channel-to-Channel ΔVF too high	Lower OTP triggered but VIINx < VSC	Any channel at below 50% of the target current will fault out after 400μs. Remaining channels driven with normal current.		Highest VF of CH0 through CH5
9	Channel-to-Channel ΔVF too high	Upper OTP triggered but VIINx < VSC	All channels switched off until chip cooled and then comes back on with current reduced to 76%. Further OTP triggers result in reduction to 53%, then 30%. Thermal event reported in Fault/Status Register.		Highest VF of CH0 through CH5
10	Output LED stack voltage too high	VOUT > VOVP	Driven with normal current. Any channel that is below 50% of the target current will time-out after 6ms.		Highest VF of CH0 through CH5
11	VOUT/LX shorted to GND	LX current and timing are monitored. OVP pin monitored for excursions below 20% of OVP threshold	Fault switch disabled and system shutdown until fault goes away, VOUT is checked at startup with a low current from LX to check for presence of short before the fault switch is enabled.		

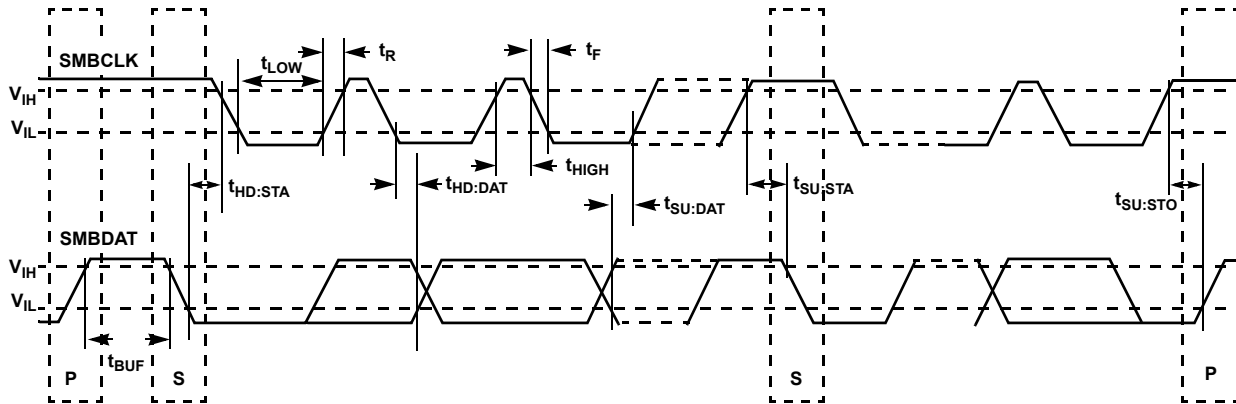

NOTES:

SMBus Description

S = start condition

P = stop condition

A = acknowledge

\bar{A} = not acknowledge

R/W = read enable at high; write enable at low

FIGURE 20. SMBUS INTERFACE

SMBus Register Definitions

The backlight controller registers are Byte wide and accessible via the SMBus Read/Write Byte protocols. Their bit assignments are provided in the following sections with reserved bits containing a default value of "0".

TABLE 2A. REGISTER LISTING

ADDRESS	REGISTER	BIT 7	BIT 6	BIT 5	BIT 4	BIT 3	BIT 2	BIT 1	BIT 0	DEFAULT VALUE	SMBUS PROTOCOL
0x00	PWM Brightness Control Register	BRT7	BRT6	BRT5	BRT4	BRT3	BRT2	BRT1	BRT0	0xFF	Read and Write
0x01	Device Control Register	Reserved	Reserved	Reserved	Reserved	Reserved	PWM_MD	PWM_SEL	BL_CTL	0x00	Read and Write
0x02	Fault/Status Register	Reserved	Reserved	2_CH_SD	1_CH_SD	BL_STAT	OV_CURR	THRM_SHDN	FAULT	0x00	Read Only
0x03	Identification Register	LED PANEL	MFG3	MFG2	MFG1	MFG0	REV2	REV1	REV0	0xC8	Read Only
0x07	DC Brightness Control Register	BRTDC7	BRTDC6	BRTDC5	BRTDC4	BRTDC3	BRTDC2	BRTDC1	BRTDC0	0xFF	Read and Write
0x08	Configuration Register	Reserved	Reserved	Reserved	Reserved	Reserved	FSW	VSC1	VSC0	0xFF	Read and Write
0x09	Output Channel Register	Reserved	Reserved	CH5	CH4	CH3	CH2	CH1	CH0	0xFF	Read and Write

TABLE 2B. DATA BIT DESCRIPTIONS

ADDRESS	REGISTER	DATA BIT DESCRIPTIONS												
0x00	PWM Brightness Control Register	BRT[7..0] = 256 steps of DPWM duty cycle brightness control												
0x01	Device Control Register	<p>PWM_MD = PWM mode select bit (1 = absolute brightness, 0 = % change), default = 0 PWM_SEL = Brightness control select bit (1 = control by PWMI, 0 = control by SMBus), default = 0 BL_CTL = BL On/Off (1 = On, 0 = Off), default = 0</p> <table border="1"> <thead> <tr> <th>PWM_MD</th> <th>PWM_SEL</th> <th>MODE</th> </tr> </thead> <tbody> <tr> <td>X</td> <td>1</td> <td>PWMI Mode</td> </tr> <tr> <td>1</td> <td>0</td> <td>SMBus Mode</td> </tr> <tr> <td>0</td> <td>0</td> <td>SMBus and PWMI mode with DPST</td> </tr> </tbody> </table>	PWM_MD	PWM_SEL	MODE	X	1	PWMI Mode	1	0	SMBus Mode	0	0	SMBus and PWMI mode with DPST
PWM_MD	PWM_SEL	MODE												
X	1	PWMI Mode												
1	0	SMBus Mode												
0	0	SMBus and PWMI mode with DPST												
0x02	Fault/Status Register	<p>2_CH_SD = Two LED output channels are shutdown (1 = shutdown, 0 = OK) 1_CH_SD = One LED output channel is shutdown (1 = shutdown, 0 = OK) BL_STAT = BL status (1 = BL On, 0 = BL Off) OV_CURR = Input overcurrent (1 = Overcurrent condition, 0 = Current OK) THRM_SHDN = Thermal Shutdown (1 = Thermal fault, 0 = Thermal OK) FAULT = Fault occurred (Logic "OR" of all of the fault conditions)</p>												
0x03	Identification Register	<p>MFG[3..0] = Manufacturer ID (16 vendors available. Intersil is vendor ID 9) REV[2..0] = Silicon rev (Rev 0 through Rev 7 allowed for silicon spins)</p>												
0x07	DC Brightness Control Register	BRTDC[7..0] = 256 steps of DC brightness control												

TABLE 2B. DATA BIT DESCRIPTIONS (Continued)

ADDRESS	REGISTER	DATA BIT DESCRIPTIONS																		
0x08	Configuration Register	<p>VSC[1..0] = Short-circuit thresholds selection FSW[2] = Switching frequencies selection</p> <table border="1"> <thead> <tr> <th>VSC1</th> <th>VSC0</th> <th>OPERATION</th> </tr> </thead> <tbody> <tr> <td>0</td> <td>X</td> <td>No VSC error detection</td> </tr> <tr> <td>1</td> <td>0</td> <td>VSC = 3.1V ±15%</td> </tr> <tr> <td>1</td> <td>1</td> <td>VSC = 8V ±15%</td> </tr> </tbody> </table> <table border="1"> <thead> <tr> <th>FSW</th> <th>OPERATION</th> </tr> </thead> <tbody> <tr> <td>0</td> <td>F_{SW} = 600kHz</td> </tr> <tr> <td>1</td> <td>F_{SW} = 1.2MHz</td> </tr> </tbody> </table>	VSC1	VSC0	OPERATION	0	X	No VSC error detection	1	0	VSC = 3.1V ±15%	1	1	VSC = 8V ±15%	FSW	OPERATION	0	F _{SW} = 600kHz	1	F _{SW} = 1.2MHz
VSC1	VSC0	OPERATION																		
0	X	No VSC error detection																		
1	0	VSC = 3.1V ±15%																		
1	1	VSC = 8V ±15%																		
FSW	OPERATION																			
0	F _{SW} = 600kHz																			
1	F _{SW} = 1.2MHz																			
0x09	Output Channel Mask / Fault Readout Register	CH[5..0] = Output Channel Read and Write. In Write, 1 = Channel Enabled, 0 = Channel Disabled. In Read, 1 = Channel OK, 0 = Channel Not OK/Channel disabled																		

PWM Brightness Control Register (0x00)

The Brightness control resolution has 256 steps of PWM duty cycle adjustment. The bit assignment is shown in [Figure 24](#). All of the bits in this Brightness Control Register can be read or write. Step 0 corresponds to the minimum step where the current is less than 10µA. Step 1 to step 255 represent the linear steps between 0.39% and 100% duty cycle with approximately 0.39% duty cycle adjustment per step.

- An SMBus Write Byte cycle to register 0x00 sets the PWM brightness level only if the backlight controller is in SMBus mode (see [Table 3](#) Operating Modes selected by Device Control Register Bits 1 and 2).
- An SMBus Read Byte cycle to register 0x00 returns the programmed PWM brightness level regardless of the value of PWM_SEL.
- An SMBus setting of 0xFF for register 0x00 sets the backlight controller to the maximum brightness.
- An SMBus setting of 0x00 for register 0x00 sets the backlight controller to the minimum brightness output in which the LED current is guaranteed to be less than 10µA.
- Default value for register 0x00 is 0xFF.

Device Control Register (0x01)

This register has two bits that control the operating mode of the backlight controller and a single bit that controls the BL ON/OFF state. The remaining bits are reserved. The bit assignment is shown in [Figure 25](#). All other bits in the Device Control Register will read as low unless otherwise written. Bits 7 and 6 are not implemented and will always read low.

TABLE 3. OPERATING MODES SELECTED BY DEVICE CONTROL REGISTER BITS 1 AND 2

PWM_MD	PWM_SEL	MODE
X	1	PWMI Mode
1	0	SMBus Mode
0	0	SMBus and PWMI Mode with DPST

REGISTER 0x00		PWM BRIGHTNESS CONTROL REGISTER					
BRT7	BRT6	BRT5	BRT4	BRT3	BRT2	BRT1	BRT0
Bit 7 (R/W)	Bit 6 (R/W)	Bit 5 (R/W)	Bit 4 (R/W)	Bit 3 (R/W)	Bit 2 (R/W)	Bit 1 (R/W)	Bit 0 (R/W)
BIT ASSIGNMENT		BIT FIELD DEFINITIONS					
BRT[7..0]		= 256 steps of PWM brightness levels					

FIGURE 24. DESCRIPTIONS OF BRIGHTNESS CONTROL REGISTER

REGISTER 0x01		DEVICE CONTROL REGISTER					
RESERVED	RESERVED	RESERVED	RESERVED	RESERVED	PWM_MD	PWM_SEL	BL_CTL
Bit 7 (R/W)	Bit 6 (R/W)	Bit 5 (R/W)	Bit 4 (R/W)	Bit 3 (R/W)	Bit 2 (R/W)	Bit 1 (R/W)	Bit 0 (R/W)
BIT ASSIGNMENT		BIT FIELD DEFINITIONS					
PWM_MD		= PWM mode select bit (1 = absolute brightness, 0 = % change) default = 0					
PWM_SEL		= Brightness control select bit (1 = control by PWMI, 0 = control by SMBus) default = 0					
BL_CTL		= BL On/Off (1 = On, 0 = Off) default = 0					

FIGURE 25. DESCRIPTIONS OF DEVICE CONTROL REGISTER

The PWM_SEL bit determines whether the SMBus or PWMI input should drive the output brightness in terms of PWM dimming. When PWM_SEL bit is 1, the PWMI drives the output brightness regardless of what the PWM_MD is.

When the PWM_SEL bit is 0, the PWM_MD bit selects the manner in which the PWM dimming is to be interpreted; when this bit is 1, the PWM dimming is based on the SMBus brightness setting. When this bit is 0, the PWM dimming reflects a percentage change in the current brightness programmed in the SMBus register 0x00, i.e. DPST (Display Power Saving Technology) mode as shown in Equation 15:

$$\text{DPST Brightness} = \text{Cbt} \times \text{PWMI} \quad (\text{EQ. 15})$$

where:

Cbt = Current brightness setting from SMBus register 0x00 without influence from the PWMI

PWMI = is the percent duty cycle of the PWMI

For example, the Cbt = 50% duty cycle programmed in the SMBus register 0x00 and the PWM frequency is tuned to be 200Hz with an appropriate capacitor at the FPWM pin. On the other hand, PWMI is fed with a 1kHz 30% high PWM signal. When PWM_SEL = 0 and PWM_MD = 0, the device is in DPST operation where DPST brightness = 15% PWM dimming at 200Hz.

- All reserved bits return a “0” when read.
- All reserved bits have no functional effect when written.
- All defined control bits return their current, latched value when read.
- A value of 1 written to BL_CTL turns on the BL in 4ms or less after the write cycle completes. The BL is deemed to be on when Bit 3 BL_STAT of register 0x02 is 1 and register 0x09 is not 0. See [Figures 24](#) and [25](#).
- A value of 0 written to BL_CTL immediately turns off the BL. The BL is deemed to be off when Bit 3 BL_STAT of register 0x02 is 0 and register 0x09 is 0. See [Figures 24](#) and [25](#).
- ** Note that the behavior of register 0x00 (Brightness Control Register) is affected by certain combinations of the control bits, as shown in [Table 3](#) “Operating Modes Selected by Device Control Register Bits 1 and 2.”
- When an SMBus mode is selected, register 0x00 reflects the last value written to it. But, when any non-SMBus mode is selected, register 0x00 reflects the current brightness value based on the current mode of operation, with the exception of SMBus mode with DPST, where PWM_MD = 0 and PWM_SEL = 0.

- When SMBus mode with DPST is selected, register 0x00 reflects the last value written to it from SMBus.
- When a write to register 0x01 (Device Control Register) causes the backlight controller to transition to an SMBus mode, the brightness of the BL does not change. On the other hand, when a write to register 0x01 causes the backlight controller to transition to a non-SMBus mode, the brightness of the BL changes as appropriate for the new mode.
- The default value for register 0x01 is 0x00.

Fault/Status Register (0x02)

This register has six status bits that allow monitoring of the backlight controller’s operating state. Bit 0 is a logical “OR” of all fault codes to simplify error detection. Not all of the bits in this register are fault related (Bit 3 is a simple BL status indicator). The remaining bits are reserved and return a “0” when read and ignore the bit value when written. All of the bits in this register are read only, with the exception of Bit 0, which can be cleared by writing to it.

- A Read Byte cycle to register 0x02 indicates the current BL on/off status in BL_STAT (1 if the BL is on, 0 if the BL is off).
- A Read Byte cycles to register 0x2 also returns FAULT as the logical OR of THRM_SHDN, OV_CURR, 2_CH_SD, and 1_CH_SD should these events occur.
- 1_CH_SD returns a 1 if one or more channels have faulted out.
- 2_CH_SD returns a 1 if two or more channels have faulted out.
- A fault will not be reported in the event the BL is commanded on and immediately off by the system.
- When FAULT is set to 1, it will remain at 1 even if the signal which sets it goes away. FAULT will be cleared when the BL_CTL bit of the Device Control Register is toggled or when written low. At that time, if the fault condition is still present or reoccurs, FAULT will be set to 1 again. BL_STAT will not cause FAULT to be set.
- The controller will not indicate a fault if the VBL+ goes away, whether or not the LEDs were on at the time of the power loss. This can occur if there is some hang condition that causes the user to force the system off by holding the power button down for 4s.

Default value for register 0x02 is 0x00.

REGISTER 0x02	FAULT/STATUS REGISTER
----------------------	------------------------------

RESERVED	RESERVED	2_CH_SD	1_CH_SD	BL_STAT	OV_CURR	THRM_SHDN	FAULT
Bit 7 (R)	Bit 6 (R)	Bit 5 (R)	Bit 4 (R)	Bit 3 (R)	Bit 2 (R)	Bit 1 (R)	Bit 0 (R)

BIT	BIT ASSIGNMENT	BIT FIELD DEFINITIONS
Bit 5	2_CH_SD	= Two LED output channels are shutdown (1 = shutdown, 0 = OK)
Bit 4	1_CH_SD	= One LED output channel is shutdown (1 = shutdown, 0 = OK)
Bit 3	BL_STAT	= BL Status (1 = BL On, 0 = BL Off)
Bit 2	OV_CURR	= Input Overcurrent (1 = Overcurrent condition, 0 = Current OK)
Bit 1	THRM_SHDN	= Thermal Shutdown (1 = Thermal Fault, 0 = Thermal OK)
Bit 0	FAULT	= Fault occurred (Logic “OR” of all of the fault conditions)

FIGURE 26. DESCRIPTIONS OF FAULT/STATUS REGISTER

Identification Register (0x03)

The ID register contains three bit fields to denote the LED driver (always set to 1), manufacturer and the silicon revision of the controller IC. The bit field widths allow up to 16 vendors with up to eight silicon revisions each. In order to keep the number of silicon revisions low, the revision field will not be updated unless the part will make it out to the user's factory. Thus, if during the engineering development process three Silicon spins were needed,

the next available revision ID would be used for all three spins until that same ID made it to the factory. Except Bit 7 which has to be 1, all of the bits in this register are read-only.

- Vendor ID 9 represents Intersil Corp.
- Default value for register 0x03 is 0xC8.

The initial value of REV shall be 0. Subsequent values of REV will increment by 1.

REGISTER 0x03		ID REGISTER					
LED PANEL	MFG3	MFG2	MFG1	MFG0	REV2	REV1	REV0
Bit 7 = 1	Bit 6 (R)	Bit 5 (R)	Bit 4 (R)	Bit 3 (R)	Bit 2 (R)	Bit 1 (R)	Bit 0 (R)

BIT ASSIGNMENT	BIT FIELD DEFINITIONS
MFG[3..0]	= Manufacturer ID. See "Identification Register (0x03)" on page 22. data 0 to 8 in decimal correspond to other vendors data 9 in decimal represents Intersil ID data 10 to 14 in decimal are reserved data 15 in decimal Manufacturer ID is not implemented
REV[2..0]	= Silicon rev (Rev 0 through Rev 7 allowed for silicon spins)

FIGURE 27. DESCRIPTIONS OF ID REGISTER

DC Brightness Control Register (0x07)

The DC Brightness Control Register 0x07 allows users to have additional dimming flexibility as:

1. Achieving effectively 16-bit of dimming control when combined DC dimming with PWM dimming or
2. Achieving visual or audio noise free 8-bit DC dimming over potentially noisy PWM dimming.

The bit assignment is shown in [Figure 28](#). All of the bits in this Register can be read or write. Steps 0 to 255 represent the linear steps of current adjustment in DC on the fly. It can also be

considered as the peak current factory calibration feature to account for various LED production batches variations but external EEPROM settings storing and restoring are required.

- An SMBus Write Byte cycle to register 0x07 sets the brightness level in DC only.
- An SMBus Read Byte cycle to register 0x07 returns the current DC brightness level.
- Default value for register 0x07 is 0xFF.

REGISTER 0x07				DC BRIGHTNESS CONTROL REGISTER			
BRTDC7	BRTDC6	BRTDC5	BRTDC4	BRTDC3	BRTDC2	BRTDC1	BRTDC0
Bit 7 (R/W)	Bit 6 (R/W)	Bit 5 (R/W)	Bit 4 (R/W)	Bit 3 (R/W)	Bit 2 (R/W)	Bit 1 (R/W)	Bit 0 (R/W)

BIT ASSIGNMENT	BIT FIELD DEFINITIONS
BRTDC[7..0]	= 256 steps of DC brightness levels

FIGURE 28. DESCRIPTIONS OF DC BRIGHTNESS CONTROL REGISTER

Configuration Register (0x08)

The Configuration Register allows users to set 2 levels of channel Short-Circuit thresholds or disable it. It also allows users to set the boost conversion switching frequency between 1.2MHz and 600kHz.

The bit assignment is shown in [Figure 29](#). Default value for register 0x08 is 0xFF

Output Channel Mask/Fault Readout Register (0x09)

This register can be read or write; the bit position corresponds to the channel. For example, Bit 0 corresponds to Ch0 and bit 5

corresponds to Ch5 and so on. When writing data to this register, it enables the channels of interest. When reading data from this register, any disabled channel and any faulted out channel will read as 0. This allows the user to determine which channel is faulty and optionally not enabling it to allow the rest of the system to continue to function. Additionally, a faulted out channel can be disabled and re-enabled in order to allow a retry for any faulty channel without having to power-down the other channels.

The bit assignment is shown in [Figure 30](#). Default for register 0x09 is 0xFF.

REGISTER 0x08		CONFIGURATION REGISTER					
RESERVED	RESERVED	RESERVED	RESERVED	RESERVED	FSW	VSC1	VSC0
Bit 7 (R/W)	Bit 6 (R/W)	Bit 5 (R/W)	Bit 4 (R/W)	Bit 3 (R/W)	Bit 2 (R/W)	Bit 1 (R/W)	Bit 0 (R/W)

BIT ASSIGNMENT	BIT FIELD DEFINITIONS
VSC[1..0]	2 levels of Short-Circuit Thresholds (1 = 8V, 0 = 3.1V, accuracy $\pm 15\%$)
FSW[2]	2 levels of Switching Frequencies (1 = 1,200kHz, 0 = 600kHz)

FIGURE 29. DESCRIPTIONS OF CONFIGURATION REGISTER

REGISTER 0x09		OUTPUT CHANNEL REGISTER					
RESERVED	RESERVED	CH5	CH4	CH3	CH2	CH1	CH0
Bit 7 (R/W)	Bit 6 (R/W)	Bit 5 (R/W)	Bit 4 (R/W)	Bit 3 (R/W)	Bit 2 (R/W)	Bit 1 (R/W)	Bit 0 (R/W)

BIT ASSIGNMENT	BIT FIELD DEFINITIONS
CH[5..0]	CH5 = Channel 5, CH4 = Channel 4 and so on

FIGURE 30. OUTPUT CHANNEL REGISTER

Components Selections

According to the inductor Voltage-Second Balance principle, the change of inductor current during the switching regulator On-time is equal to the change of inductor current during the switching regulator Off-time. Since the voltage across an inductor is:

$$V_L = L \times \Delta I_L / \Delta t \quad (\text{EQ. 16})$$

and ΔI_L at On = ΔI_L at Off, therefore:

$$(V_I - 0) / L \times D \times t_S = (V_O - V_D - V_I) / L \times (1 - D) \times t_S \quad (\text{EQ. 17})$$

where D is the switching duty cycle defined by the turn-on time over the switching period. V_D is Schottky diode forward voltage that can be neglected for approximation.

Rearranging the terms without accounting for V_D gives the boost ratio and duty cycle respectively as [Equations 18](#) and [19](#):

$$V_O / V_I = 1 / (1 - D) \quad (\text{EQ. 18})$$

$$D = (V_O - V_I) / V_O \quad (\text{EQ. 19})$$

Input Capacitor

Switching regulators require input capacitors to deliver peak charging current and to reduce the impedance of the input supply. This reduces interaction between the regulator and input supply, improving system stability. The high switching frequency of the loop causes almost all ripple current to flow in the input capacitor, which must be rated accordingly.

A capacitor with low internal series resistance should be chosen to minimize heating effects and improve system efficiency, such as X5R or X7R ceramic capacitors, which offer small size and a lower value of temperature and voltage coefficient compared to other ceramic capacitors.

In boost mode, input current flows continuously into the inductor, with an AC ripple component proportional to the rate of inductor charging only and smaller value input capacitors may be used. It is recommended that an input capacitor of at least 10 μ F be used. Ensure the voltage rating of the input capacitor is suitable to handle the full supply range.

Inductor

The selection of the inductor should be based on its maximum current (I_{SAT}) characteristics, power dissipation (DCR), EMI susceptibility (shielded vs unshielded), and size. Inductor type and value influence many key parameters, including ripple current, current limit, efficiency, transient performance and stability.

Its maximum current capability must be adequate to handle the peak current at the worst case condition. If an inductor core is chosen with too low a current rating, saturation in the core will cause the effective inductor value to fall, leading to an increase in peak to average current level, poor efficiency and overheating in the core. The series resistance, DCR, within the inductor causes conduction loss and heat dissipation. A shielded inductor

is usually more suitable for EMI susceptible applications, such as LED backlighting.

The peak current can be derived from the fact that the voltage across the inductor during the Off-period can be shown as [Equation 20](#):

$$I_{L_{peak}} = (V_O \times I_O) / (85\% \times V_I) + 1/2[V_I \times (V_O - V_I) / (L \times V_O \times f_S)] \quad (\text{EQ. 20})$$

The choice of 85% is just an average term for the efficiency approximation. The first term is average current that is inversely proportional to the input voltage. The second term is inductor current change that is inversely proportional to L and f_S . As a result, for a given switching frequency and minimum input voltage the system operates, the inductor I_{SAT} must be chosen carefully. At a given inductor size, usually the larger the inductance, the higher the series resistance because of the extra winding of the coil. Thus, the higher the inductance, the lower the peak current capability. The ISL97635A current limit may also have to be taken into account.

Output Capacitors

The output capacitor acts to smooth the output voltage and supplies load current directly during the conduction phase of the power switch. Output ripple voltage consists of the discharge of the output capacitor for $I_{L_{PEAK}}$ during FET On and the voltage drop due to flowing through the ESR of the output capacitor. The ripple voltage can be shown as [Equation 21](#):

$$\Delta V_{CO} = (I_O / C_O \times D / f_S) + (I_O \times \text{ESR}) \quad (\text{EQ. 21})$$

The conservation of charge principle in [Equation 19](#) also brings up a fact that during the boost switch off-period, the output capacitor is charged with the inductor ripple current minus a relatively small output current in boost topology. As a result, the users need to select an output capacitor with low ESD and with a enough input ripple current capability.

Output Ripple

ΔV_{CO} can be reduced by increasing C_O or f_S , or using small ESR capacitors. In general, ceramic capacitors are the best choice for output capacitors in small to medium sized LCD backlight applications due to their cost, form factor, and low ESR.

A larger output capacitor will also ease the driver respond during PWM dimming Off-period due to the longer sample and hold effect of the output drooping. The driver does not need to boost harder in the next On-period that minimizes transient current. The output capacitor is also needed for compensation and in general 2x4.7 μ F/50V ceramic capacitors are suitable for the notebook display backlight applications.

Schottky Diode

A high speed rectifier diode is necessary to prevent excessive voltage overshoot, especially in the boost configuration. Low forward voltage and reverse leakage current will minimize losses, making Schottky diodes the preferred choice. Although the Schottky diode turns on only during the boost switch Off-period, it carries the same peak current as the inductor's, and therefore, a suitable current rated Schottky diode must be used.

Applications

High Current Applications

Each channel of the ISL97635A can support up to 35mA. For applications that need higher current, multiple channels can be grouped to achieve the desirable current. For example, the cathode of the last LED can be connected to IIN0 to IIN2; this configuration can be treated as a single string with 105mA current driving capability.

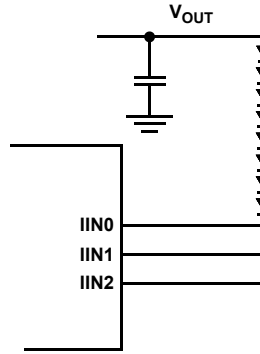

FIGURE 31. GROUPING MULTIPLE CHANNELS FOR HIGH CURRENT APPLICATIONS

Multiple Drivers Operation

For large LCD panels where more than six channels of LEDs are needed, multiple ISL97635As with each driver having its own supporting components can be controlled together with the common SMBus. While the ISL97635A does not have extra pins strappable slave address feature, a separate EN signal can be applied to each driver for asynchronous operation. A trade-off of such scheme is that an exact faulty channel cannot be identified if the EN/PWMI signal is common to all drivers.

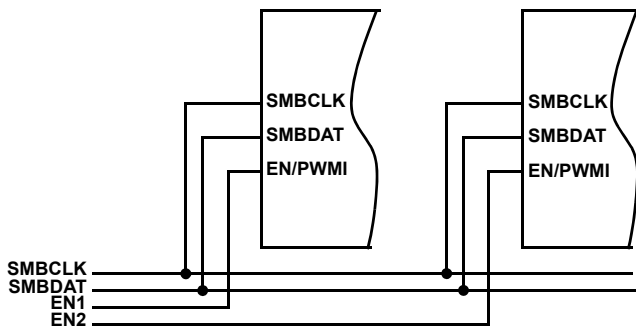

FIGURE 32. MULTIPLE DRIVERS OPERATION

16-Bit Dimming

The SMBus controlled PWM and DC dimmings can be combined to effectively provide 16 bits of dimming capability, which can be valuable for automotive and avionics display applications.

Figure 33 illustrates one programming example where 256 steps of PWM dimming can be programmed between each DC dimming steps or vice versa.

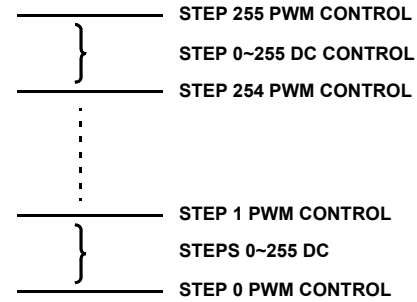

FIGURE 33. 16-BIT DIMMING ILLUSTRATION

RGB LED Backlight or Scrolling Backlight Operation

The SMBus control features of PWM dimming, DC dimming, and random channels selection have offered many driving possibilities. For example, red, green, and blue LEDs can be arranged in Ch0 and Ch1, Ch2 and Ch3, Ch4 and Ch5 respectively such that each group can be controlled independently in sequential order for RGB LED backlighting applications.

Compensation

The ISL97635A has two main elements in the system; the Current Mode Boost Regulator and the op amp based multi-channel current sources. The ISL97635A incorporates a transconductance amplifier in its feedback path to allow the user some levels of adjustment on the transient response and better regulation. The ISL97635A uses current mode control architecture, which has a fast current sense loop and a slow voltage feedback loop. The fast current feedback loop does not require any compensation. The slow voltage loop must be compensated for stable operation. The compensation network is a series Rc, Cc1 network from COMP pin to ground and an optional Cc2 capacitor connected to the COMP pin. The Rc sets the high frequency integrator gain for fast transient response and the Cc1 sets the integrator zero to ensure loop stability. For most applications, Rc is in the range of 200Ω to 3kΩ and Cc1 is in the range of 27nF to 37nF. Depending upon the PCB layout, a Cc2, in range of 100nF, may be needed to create a pole to cancel the output capacitor ESR's zero effect for stability. The ISL97635A evaluation board is configured with Rc1 of 500Ω, Cc1 of 33nF, and Cc2 of 0, which achieves stability. In the actual applications, these values may need to be tuned empirically but the recommended values are usually a good starting point.

Revision History

The revision history provided is for informational purposes only and is believed to be accurate, but not warranted. Please visit our website to make sure you have the latest revision.

DATE	REVISION	CHANGE
Sep 26, 2017	FN6564.3	<p>Applied new header/footer.</p> <p>Updated Ordering Information notes.</p> <p>Moved Note 4 to end of EC table.</p> <p>Added V_{HEADROOM_RANGE} spec to EC table.</p> <p>Added Note 5.</p> <p>In "Current Matching and Current Accuracy" on page 11 updated 2nd sentence in paragraph 2 for clarification.</p> <p>Added Revision History and About Intersil sections.</p> <p>Updated POD L24.4x4D to the latest revision. Changes are as follows:</p> <p>-Changed tolerance in Bottom View from 2.50 +0.15 to 2.45 +0.10mm -0.15mm.</p>

About Intersil

Intersil Corporation is a leading provider of innovative power management and precision analog solutions. The company's products address some of the largest markets within the industrial and infrastructure, mobile computing, and high-end consumer markets. For the most updated datasheet, application notes, related documentation, and related parts, see the respective product information page found at www.intersil.com.

For a listing of definitions and abbreviations of common terms used in our documents, visit www.intersil.com/glossary.

You can report errors or suggestions for improving this datasheet by visiting www.intersil.com/ask.

Reliability reports are also available from our website at www.intersil.com/support.

© Copyright Intersil Americas LLC 2008-2017. All Rights Reserved.
All trademarks and registered trademarks are the property of their respective owners.

For additional products, see www.intersil.com/en/products.html

Intersil products are manufactured, assembled and tested utilizing ISO9001 quality systems as noted in the quality certifications found at www.intersil.com/en/support/qualandreliability.html

Intersil products are sold by description only. Intersil may modify the circuit design and/or specifications of products at any time without notice, provided that such modification does not, in Intersil's sole judgment, affect the form, fit or function of the product. Accordingly, the reader is cautioned to verify that datasheets are current before placing orders. Information furnished by Intersil is believed to be accurate and reliable. However, no responsibility is assumed by Intersil or its subsidiaries for its use; nor for any infringements of patents or other rights of third parties which may result from its use. No license is granted by implication or otherwise under any patent or patent rights of Intersil or its subsidiaries.

For information regarding Intersil Corporation and its products, see www.intersil.com

Package Outline Drawing

For the most recent package outline drawing, see [L24.4x4D](#).

L24.4x4D

24 LEAD QUAD FLAT NO-LEAD PLASTIC PACKAGE

Rev 3, 11/13

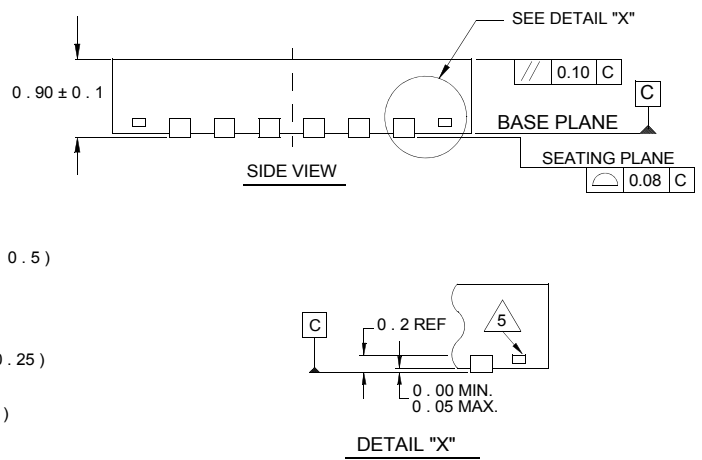
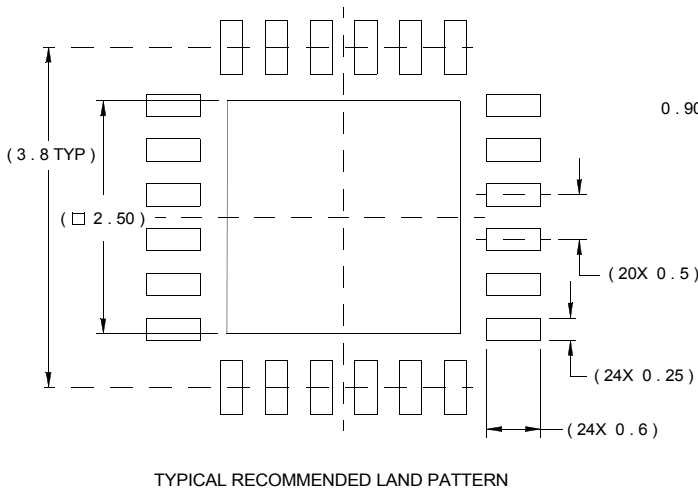
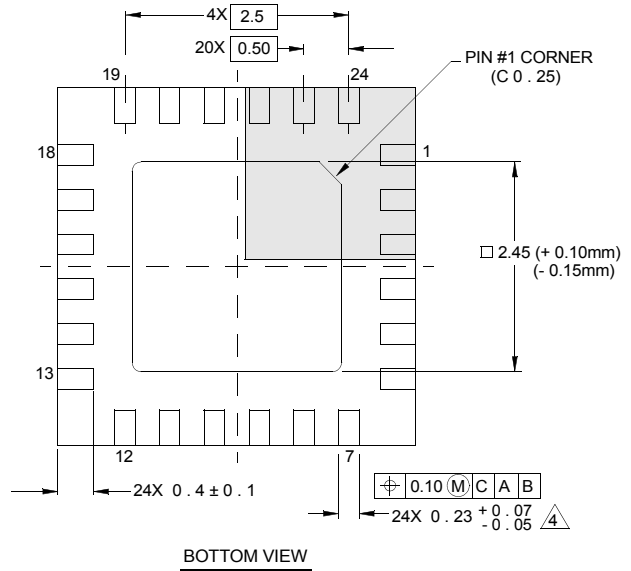
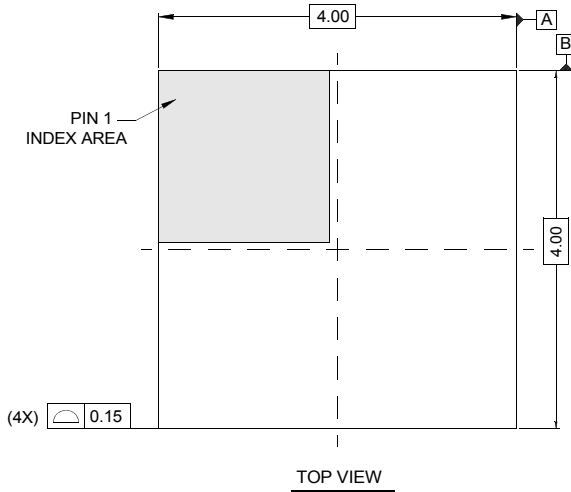

NOTES:

1. Dimensions are in millimeters.
Dimensions in () for Reference Only.
2. Dimensioning and tolerancing conform to AMSE Y14.5m-1994.
3. Unless otherwise specified, tolerance : Decimal ± 0.05
4. Dimension b applies to the metallized terminal and is measured between 0.15mm and 0.30mm from the terminal tip.
5. Tiebar shown (if present) is a non-functional feature.
6. The configuration of the pin #1 identifier is optional, but must be located within the zone indicated. The pin #1 identifier may be either a mold or mark feature.