

ISL8018

8A Low Quiescent Current High Efficiency Synchronous Buck Regulator

FN7889

Rev 0.00

September 30, 2015

The **ISL8018** is a high efficiency, monolithic, synchronous step-down DC/DC converter that can deliver up to 8A continuous output current from a 2.7V to 5.5V input supply. The output voltage is adjustable from 0.6V to V_{IN} . With an adjustable current limit, reverse current protection, prebias start and over-temperature protection, the ISL8018 offers a highly robust power solution. It uses current control architecture to deliver fast transient response and excellent loop stability.

The ISL8018 integrates a pair of low ON-resistance P-channel and N-channel internal MOSFETs to maximize efficiency and minimize external component count. 100% duty-cycle operation allows less than 250mV dropout at 8A output current. Adjustable frequency and synchronization allow the ISL8018 to be used in applications requiring low noise.

The ISL8018 can be configured for discontinuous or forced continuous operation at light load. Forced continuous operation reduces noise and RF interference while discontinuous mode provides high efficiency by reducing switching losses at light loads.

The ISL8018 is offered in a space saving 20 Ld 3x4 QFN lead free package with exposed pad lead frames for excellent thermal performance. The complete converter occupies less than 96.8mm² area.

See Ordering Information on [page 2](#) for more detail.

Related Literature

- [UG052](#) "ISL8018DEM01Z Demonstration Board User Guide"
- [UG053](#) "ISL8018EVAL3Z Evaluation Board User Guide"

Features

- High efficiency synchronous buck regulator with up to 97% efficiency
- ±10% output voltage margining
- Adjustable current limit
- Start-up with prebiased output
- Internal soft-start - 1ms or adjustable, internal/external compensation
- Soft-stop output discharge during disabled
- Adjustable frequency from 500kHz to 4MHz - default at 1MHz
- External synchronization up to 4MHz - master to slave phase shifting capability
- Peak current limiting, hiccup mode short-circuit protection and over-temperature protection

Applications

- DC/DC POL modules
- μ C/ μ P, FPGA and DSP power
- Plug-in DC/DC modules for routers and switchers
- Portable instruments
- Test and measurement systems
- Li-ion battery powered devices

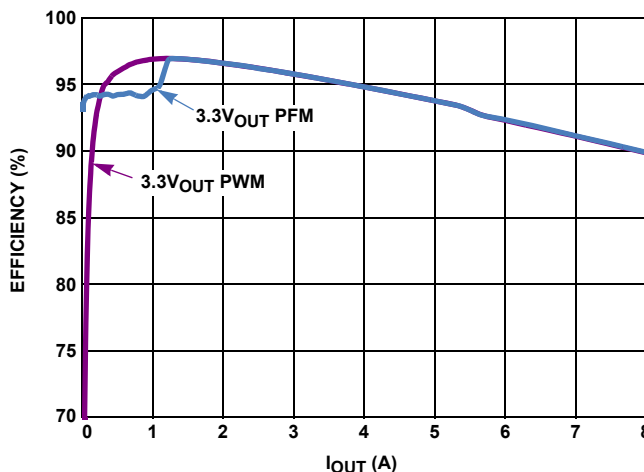

FIGURE 1. EFFICIENCY T = +25°C V_{IN} = 5V

Ordering Information

PART NUMBER (Notes 1, 2, 3)	PART MARKING	OUTPUT VOLTAGE (V)	TEMP. RANGE (°C)	PACKAGE (RoHS Compliant)	PKG. DWG. #
ISL8018IRAJZ	018A	Adjustable	-40 to +85	20 Ld 3x4 QFN	L20.3x4
ISL8018EVAL3Z	Evaluation Board				
ISL8018DEMO1Z	Demonstration Board				

NOTES:

1. Add "-T" suffix for 6k units or "-T7A" suffix for 250 units Tape and Reel options. Please refer to [TB347](#) for details on reel specifications.
2. These Intersil Pb-free plastic packaged products employ special Pb-free material sets, molding compounds/die attach materials, and 100% matte tin plate plus anneal (e3 termination finish, which is RoHS compliant and compatible with both SnPb and Pb-free soldering operations). Intersil Pb-free products are MSL classified at Pb-free peak reflow temperatures that meet or exceed the Pb-free requirements of IPC/JEDEC J STD-020.
3. For Moisture Sensitivity Level (MSL), please see device information page for [ISL8018](#). For more information on MSL please see techbrief [TB363](#).

Pin Configuration

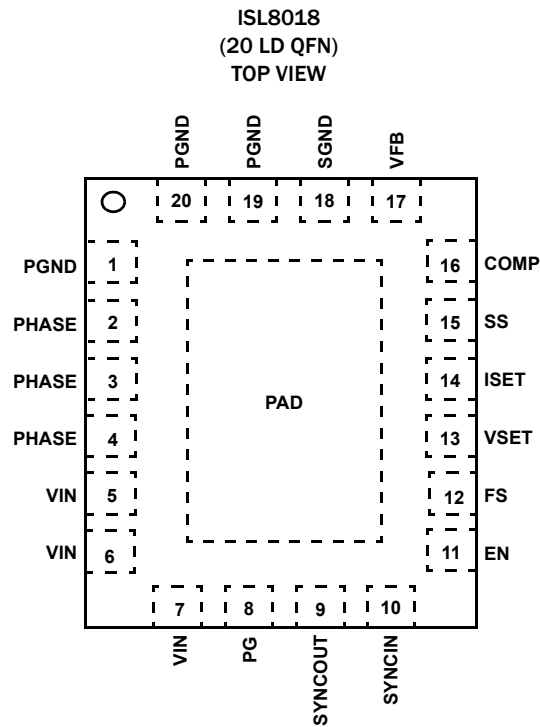

Pin Descriptions

PIN	SYMBOL	DESCRIPTION
1, 19, 20	PGND	Power ground.
2, 3, 4	PHASE	Switching node connection. Connect to one terminal of the inductor.
5, 6, 7	VIN	Input supply voltage. Connect two 22 μ F ceramic capacitors to power ground.
8	PG	Power-good is an open-drain output. Use 10k Ω to 100k Ω pull-up resistor connected between VIN and PG. At power-up or EN HI, PG rising edge is delayed by 1ms from the output reaching regulation.
9	SYNCOUT	This pin outputs a 250 μ A current source that is turned on at the rising edge of the internal clock or SYNCIN. When SYNCOUT voltage reaches 0.8V, a reset circuit will activate and discharge SYNCOUT to 0V. SYNCOUT is held at 0V in PFM light load to reduce quiescent current.
10	SYNCIN	Mode selection pin. Connect to logic high or input voltage VIN for PWM mode. Connect to logic low or ground for PFM mode. Connect to an external function generator for synchronization with the positive edge trigger. There is an internal 1M Ω pull-down resistor to prevent an undefined logic state if SYNCIN is floating.
11	EN	Regulator enable pin. Enables the output when driven to high. Shuts down the chip and discharges the output capacitor when driven to low.
12	FS	This pin sets the oscillator switching frequency, using a resistor, R _{FS} , from the FS pin to GND. The frequency of operation may be programmed between 500kHz to 4MHz. The default frequency is 1MHz and configured for internal compensation if FS is connected to VIN.
13	VSET	VSET is the output margining setting of the regulators. Connect to SGND for -10%, keep it floating for no margining and connect to VIN for +10%.
14	ISET	ISET is the peak output current limit and skip current limit setting of the regulators. Connect to SGND for 3A, to VIN for 5A and keep it floating for 8A.
15	SS	SS is used to adjust the soft-start time. Set to SGND for internal 1ms rise time. Connect a capacitor from SS to SGND to adjust the soft-start time. Do not use more than 33nF per IC.
16, 17	COMP, VFB	The feedback network of the regulator, VFB, is the negative input to the transconductance error amplifier. COMP is the output of the amplifier if the FS resistor is used. If internal compensation is used (FS = VIN), the comp pin should be tied to SGND. The output voltage is set by an external resistor divider connected to VFB. With a properly selected divider, the output voltage can be set to any voltage between VIN and the 0.6V reference. While internal compensation offers a solution for many typical applications, an external compensation network may offer improved performance for some designs. In addition to regulation, VFB is also used to determine the state of PG.
18	SGND	Signal ground.
	EPAD	The exposed pad must be connected to the SGND pin for proper electrical performance. Place as many vias as possible under the pad connecting to the system GND plane for optimal thermal performance.

Typical Application Diagrams

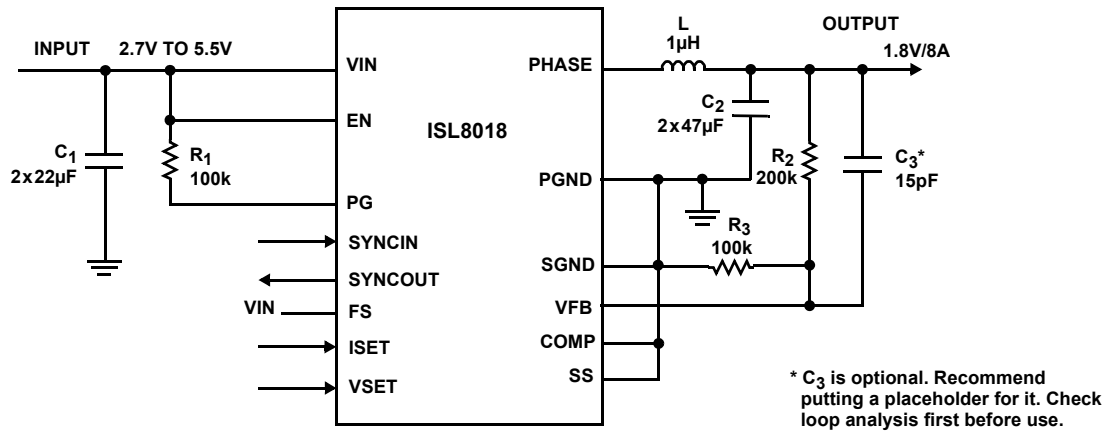

FIGURE 2. TYPICAL APPLICATION DIAGRAM - SINGLE CHIP 8A

Block Diagram

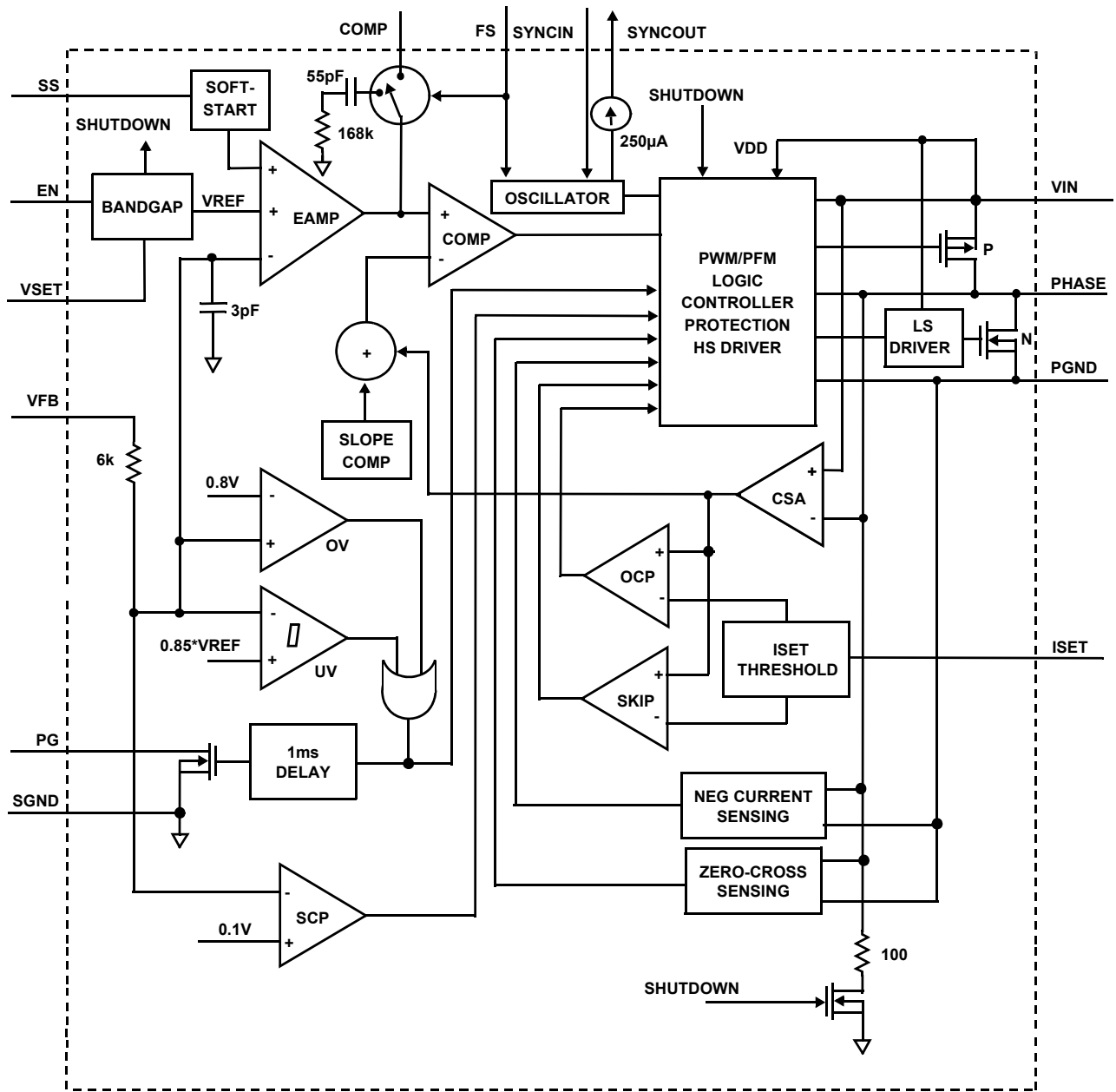

FIGURE 3. FUNCTIONAL BLOCK DIAGRAM

Absolute Maximum Ratings (Reference to GND)

VIN	-0.3V to 5.8V (DC) or 7V (20ms)
EN, FS, ISET, PG, SYNCOUT, SYNCIN VFB, VSET	-0.3V to VIN + 0.3V
PHASE	-1.5V (100ns)/-0.3V (DC) to 6.5V (DC) or 7V (20ms)
COMP, SS	-0.3V to 2.7V
ESD Rating	
Human Body Model (Tested per JESD22-A114)	3kV
Machine Model (Tested per JESD22-A115)	300V
Charged Device Model (Tested per JESD22-C101E)	1.5V
Latch-up (Tested per JESD-78A; Class 2, Level A)	100mA at +85°C

Thermal Information

Thermal Resistance (Typical)	θ_{JA} (°C/W)	θ_{JC} (°C/W)
3x4 QFN Package (Notes 4, 5)	42	5
Junction Temperature Range	-55°C to +125°C	
Storage Temperature Range	-65°C to +150°C	
Pb-free Reflow Profile	see TB493	

Recommended Operating Conditions

VIN Supply Voltage Range	2.7V to 5.5V
Load Current Range	0A to 8A
Ambient Temperature Range	-40°C to +85°C

CAUTION: Do not operate at or near the maximum ratings listed for extended periods of time. Exposure to such conditions may adversely impact product reliability and result in failures not covered by warranty.

NOTES:

- θ_{JA} is measured in free air with the component mounted on a high effective thermal conductivity test board with “direct attach” features. See Tech Brief [TB379](#).
- θ_{JC} , “case temperature” location is at the center of the exposed metal pad on the package underside.

Analog Specifications All parameter limits are established across the recommended operating conditions and are measured at the following conditions: $T_A = -40^\circ\text{C}$ to $+85^\circ\text{C}$, $V_{IN} = 3.6\text{V}$, $EN = V_{IN}$, unless otherwise noted. Typical values are at $T_A = +25^\circ\text{C}$. **Boldface limits apply across the operating temperature range, -40°C to $+85^\circ\text{C}$.**

PARAMETER	SYMBOL	TEST CONDITIONS	MIN (Note 6)	TYP	MAX (Note 6)	UNIT
INPUT SUPPLY						
VIN Undervoltage Lockout Threshold	V _{UVLO}	Rising, no load		2.5	2.7	V
		Falling, no load	2.2	2.4		V
Quiescent Supply Current	I _{VIN}	SYNCIN = GND, no load at the output		70		μA
		SYNCIN = GND, no load at the output and no switches switching		70	95	μA
		SYNCIN = VIN, f _{SW} = 1MHz, no load at the output		8	15	mA
Shutdown Supply Current	I _{SD}	SYNCIN = GND, V _{IN} = 5.5V, EN = low		5	9.5	μA
OUTPUT REGULATION						
Reference Voltage	V _{REF}	V _{SET} = V _{IN}	0.651	0.660	0.669	V
		V _{SET} = FLOAT	0.594	0.600	0.606	V
		V _{SET} = SGND	0.531	0.540	0.549	V
Output Voltage Margining	V _{VFB}	V _{SET} = V _{IN} , percent of output changed	9.5	10	10.5	%
		V _{SET} = SGND, percent of output changed	-10.5	-10	-9.5	%
VFB Bias Current	I _{VFB}	VFB = 0.75V		0.1		μA
Fixed Output VFB Bias Current	I _{VFB}	V _{SET} = FLOAT, VFB = 10% above output		6		μA
Line Regulation		V _{IN} = V _O + 0.5V to 5.5V (minimal 2.7V)		0.2		%/V
Soft-Start Ramp Time Cycle		SS = SGND		1		ms
Soft-Start Charging Current	ISS	V _{SS} = 0.1V	1.4	1.8	2.2	μA
OVERCURRENT PROTECTION						
Current Limit Blanking Time	t _{OCON}			17		Clock pulses
Overcurrent and Auto Restart Period	t _{OCOFF}			8		SS cycle

Analog Specifications All parameter limits are established across the recommended operating conditions and are measured at the following conditions: $T_A = -40^\circ\text{C}$ to $+85^\circ\text{C}$, $V_{IN} = 3.6\text{V}$, $EN = V_{IN}$, unless otherwise noted. Typical values are at $T_A = +25^\circ\text{C}$. **Boldface limits apply across the operating temperature range, -40°C to $+85^\circ\text{C}$. (Continued)**

PARAMETER	SYMBOL	TEST CONDITIONS	MIN (Note 6)	TYP	MAX (Note 6)	UNIT			
Positive Peak Current Limit	IPLIMIT	$I_{SET} = \text{FLOAT}$	9.7	12.8	15.8	A			
		$I_{SET} = V_{IN}$	6.7	8.8	10.9	A			
		$I_{SET} = \text{SGND}$	4	5.6	7.2	A			
Peak Skip Limit	ISKIP	$I_{SET} = \text{FLOAT}$	2.18	2.8	3.78	A			
		$I_{SET} = V_{IN}$	1.08	1.66	2.3	A			
		$I_{SET} = \text{SGND}$		1.05		A			
Zero Cross Threshold					-300	mA			
Negative Current Limit	INLIMIT					-4.25	-3	-1.75	A
COMPENSATION									
Error Amplifier Transconductance		$FS = V_{IN}$		100		$\mu\text{A}/\text{V}$			
		FS with resistor		200		$\mu\text{A}/\text{V}$			
Transresistance	RT			0.11		Ω			
PHASE									
P-Channel MOSFET ON-Resistance		$V_{IN} = 5\text{V}$, $I_O = 200\text{mA}$		31	45	m Ω			
		$V_{IN} = 2.7\text{V}$, $I_O = 200\text{mA}$		44	55	m Ω			
N-Channel MOSFET ON-Resistance		$V_{IN} = 5\text{V}$, $I_O = 200\text{mA}$		19	35	m Ω			
		$V_{IN} = 2.7\text{V}$, $I_O = 200\text{mA}$		25	50	m Ω			
PHASE Maximum Duty Cycle				100		%			
PHASE Minimum On-Time		SYNCIN = High			140	ns			
OSCILLATOR									
Nominal Switching Frequency	f_{SW}	$FS = V_{IN}$	800	1000	1200	kHz			
		FS with $R_S = 402\text{k}\Omega$	440	520	600	kHz			
		FS with $R_S = 42.4\text{k}\Omega$	3200	3700	4200	kHz			
SYNCIN Logic Low to High Transition Range			0.70	0.75	0.80	V			
SYNCIN Hysteresis				0.15		V			
SYNCIN Logic Input Leakage Current		$V_{IN} = 3.6\text{V}$		3.6	5	μA			
SYNCOUT Charging Current	ISO	PWM	210	250	290	μA			
		PFM		0		μA			
SYNCOUT Voltage Low					0.3	V			
PG									
Output Low Voltage					0.3	V			
Delay Time (Rising Edge)			0.5	1	2	ms			
PG Pin Leakage Current				0.01	0.1	μA			
OVP PG Rising Threshold				0.80		V			
UVP PG Rising Threshold			80	85	90	%			
UVP PG Hysteresis				5		%			
PGOOD Delay Time (Falling Edge)				7		μs			

Analog Specifications All parameter limits are established across the recommended operating conditions and are measured at the following conditions: $T_A = -40^\circ\text{C}$ to $+85^\circ\text{C}$, $V_{IN} = 3.6\text{V}$, $EN = V_{IN}$, unless otherwise noted. Typical values are at $T_A = +25^\circ\text{C}$. **Boldface limits apply across the operating temperature range, -40°C to $+85^\circ\text{C}$. (Continued)**

PARAMETER	SYMBOL	TEST CONDITIONS	MIN (Note 6)	TYP	MAX (Note 6)	UNIT
ISET, VSET						
Logic Input Low					0.4	V
Logic Input Float			0.5		0.8	V
Logic Input High			0.9			V
Logic Input Leakage Current				0.1	1	μA
EN						
Logic Input Low					0.4	V
Logic Input High			0.9			V
EN Logic Input Leakage Current				0.1	1	μA
Thermal Shutdown				150		$^\circ\text{C}$
Thermal Shutdown Hysteresis				25		$^\circ\text{C}$

NOTE:

6. Compliance to datasheet limits is assured by one or more methods: production test, characterization and/or design.

Typical Operating Performance

Unless otherwise noted, operating conditions are: $T_A = +25^\circ\text{C}$, $V_{IN} = 5\text{V}$, $EN = 3.3\text{V}$, $SYNC_{IN} = V_{IN}$, $L = 1\mu\text{H}$, $C_1 = 2 \times 22\mu\text{F}$, $C_2 = 4 \times 22\mu\text{F}$, $V_{OUT} = 1.8\text{V}$, $I_{OUT} = 0\text{A to } 8\text{A}$.

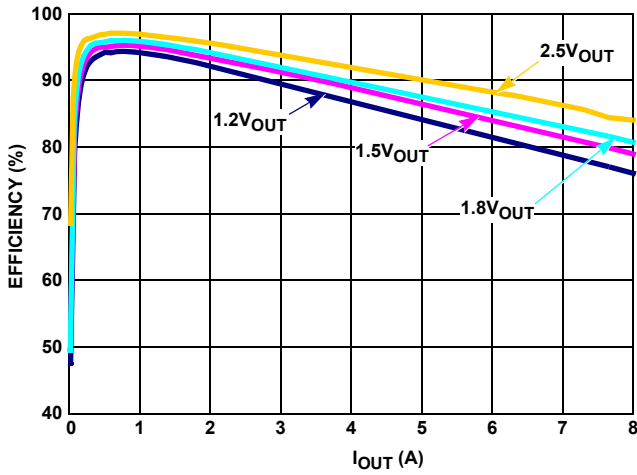

FIGURE 4. EFFICIENCY vs LOAD (1MHz 3.3VIN PWM)

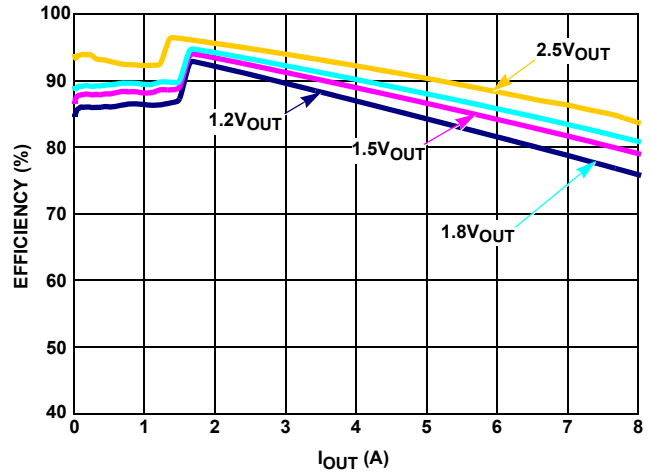

FIGURE 5. EFFICIENCY vs LOAD (1MHz 3.3VIN PFM)

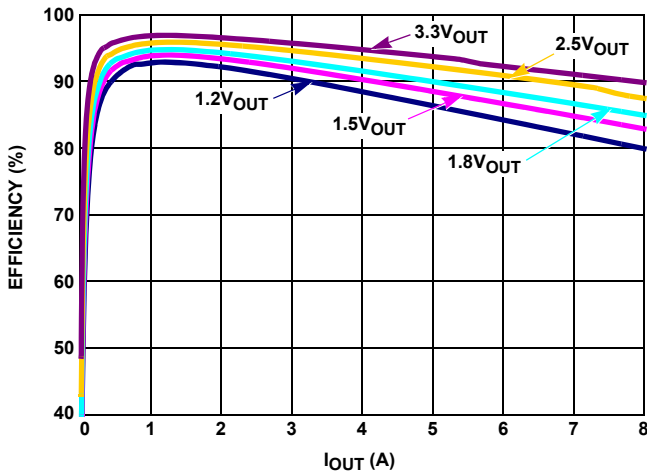

FIGURE 6. EFFICIENCY vs LOAD (1MHz 5VIN PWM)

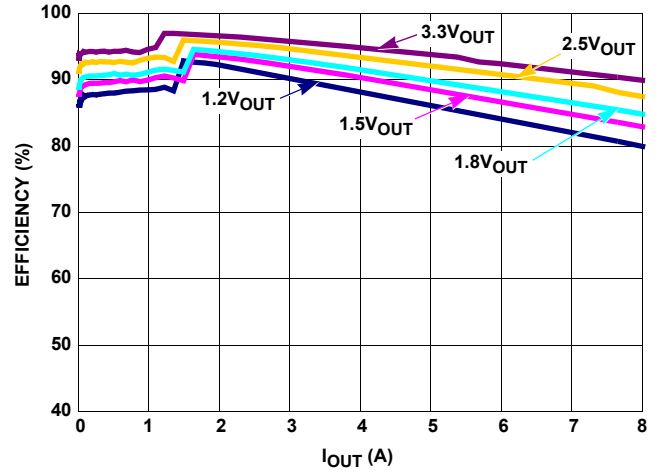

FIGURE 7. EFFICIENCY vs LOAD (1MHz 5VIN PFM)

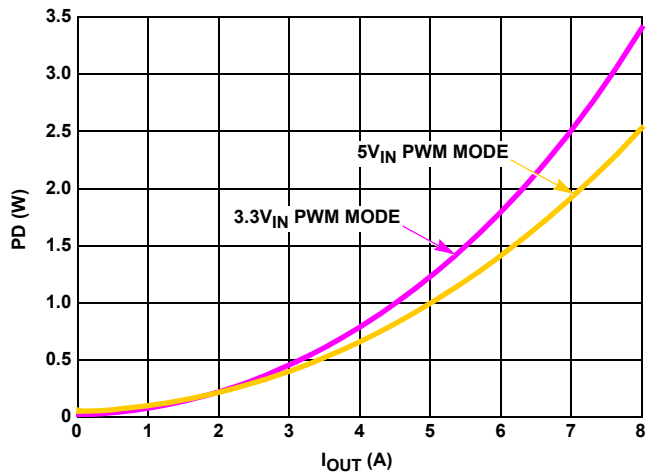

FIGURE 8. POWER DISSIPATION vs LOAD (1MHz, $V_{OUT} = 1.8\text{V}$)

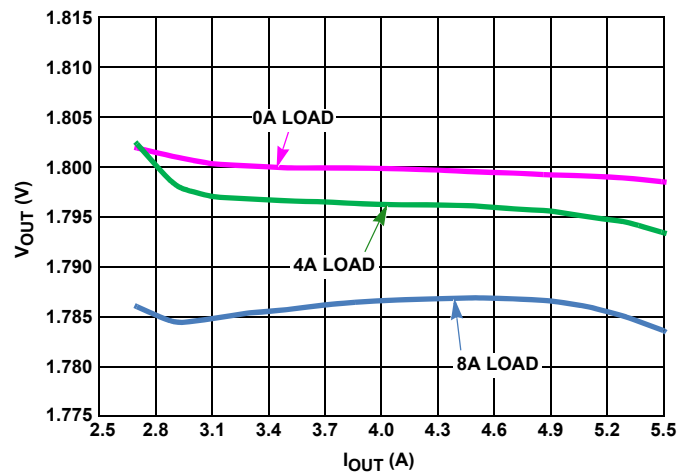

FIGURE 9. V_{OUT} REGULATION vs V_{IN} (PWM $V_{OUT} = 1.8\text{V}$)

Typical Operating Performance

Unless otherwise noted, operating conditions are: $T_A = +25^\circ\text{C}$, $V_{IN} = 5\text{V}$, $EN = 3.3\text{V}$, $SYN\text{CIN} = V_{IN}$, $L = 1\mu\text{H}$, $C_1 = 2 \times 22\mu\text{F}$, $C_2 = 4 \times 22\mu\text{F}$, $V_{OUT} = 1.8\text{V}$, $I_{OUT} = 0\text{A}$ to 8A . (Continued)

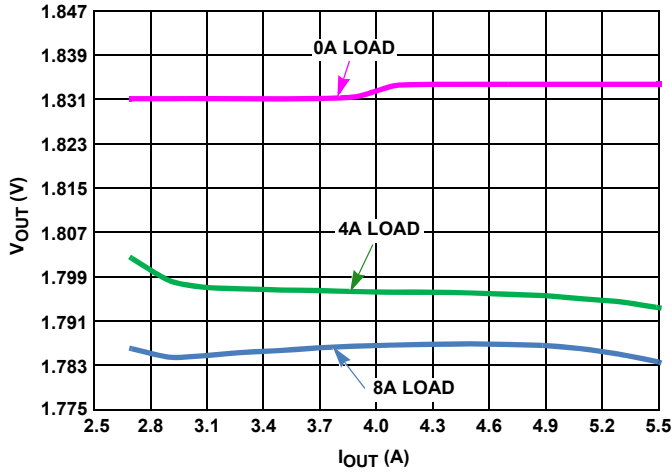

FIGURE 10. V_{OUT} REGULATION vs V_{IN} (PFM $V_{OUT} = 1.8\text{V}$)

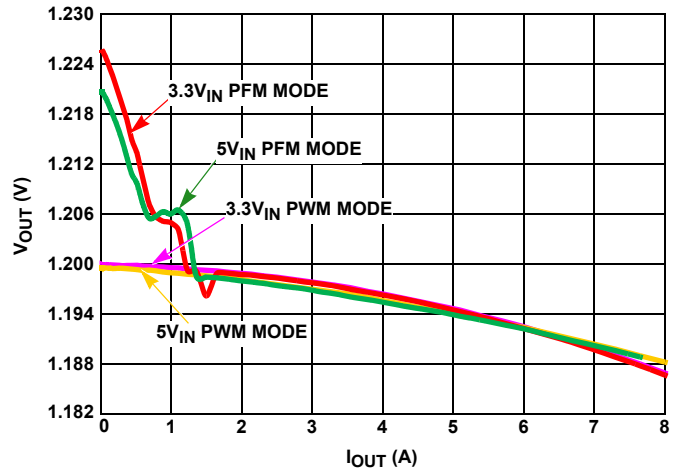

FIGURE 11. V_{OUT} REGULATION vs LOAD (1MHz, $V_{OUT} = 1.2\text{V}$)

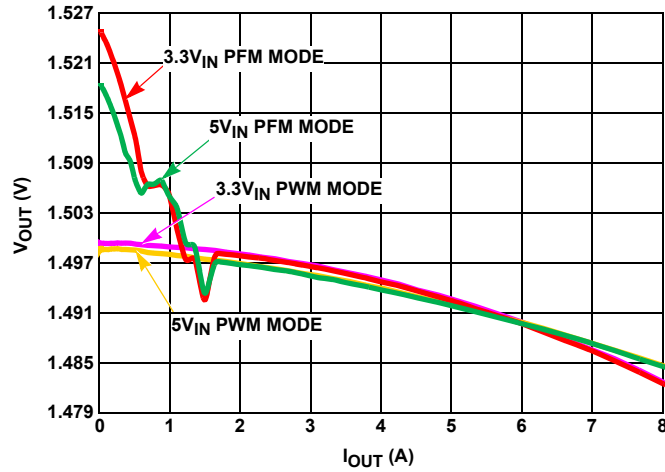

FIGURE 12. V_{OUT} REGULATION vs LOAD (1MHz, $V_{OUT} = 1.5\text{V}$)

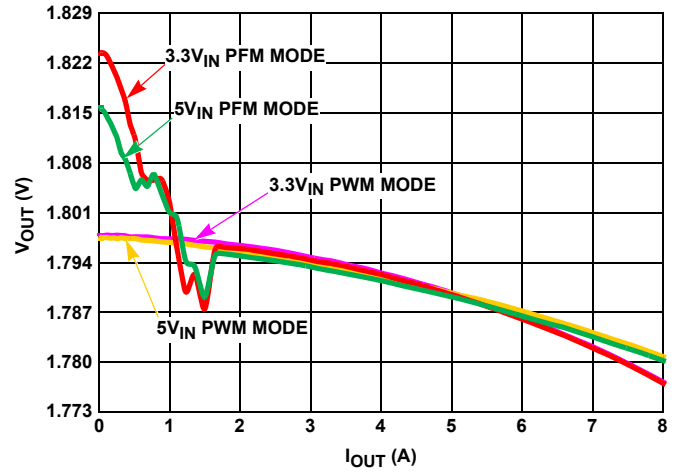

FIGURE 13. V_{OUT} REGULATION vs LOAD (1MHz, $V_{OUT} = 1.8\text{V}$)

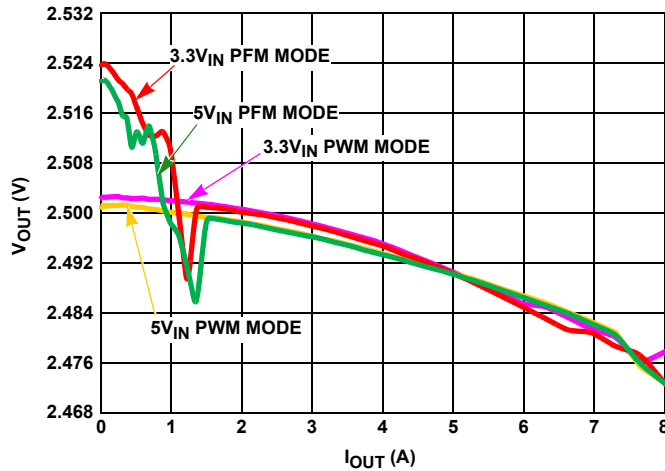

FIGURE 14. V_{OUT} REGULATION vs LOAD (1MHz, $V_{OUT} = 2.5\text{V}$)

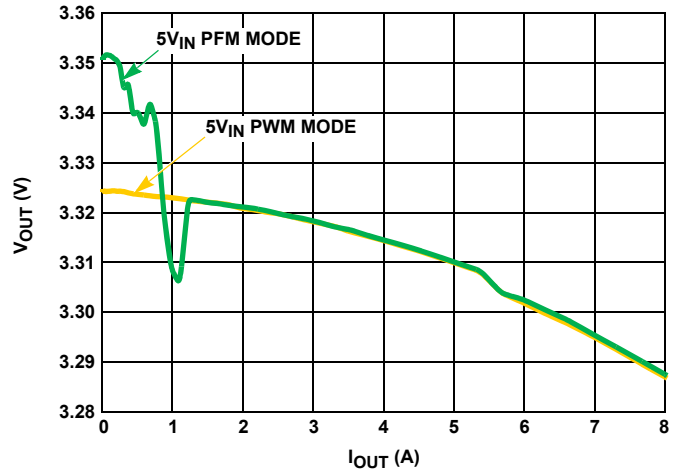

FIGURE 15. V_{OUT} REGULATION vs LOAD (1MHz, $V_{OUT} = 3.3\text{V}$)

Typical Operating Performance

Unless otherwise noted, operating conditions are: $T_A = +25^\circ\text{C}$, $V_{IN} = 5\text{V}$, $EN = 3.3\text{V}$, $SYNCIN = V_{IN}$, $L = 1\mu\text{H}$, $C_1 = 2 \times 22\mu\text{F}$, $C_2 = 4 \times 22\mu\text{F}$, $V_{OUT} = 1.8\text{V}$, $I_{OUT} = 0\text{A to } 8\text{A}$. (Continued)

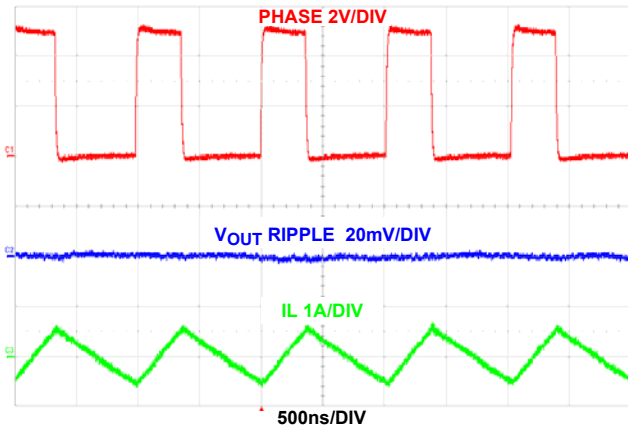

FIGURE 16. STEADY STATE OPERATION AT NO LOAD (PWM)

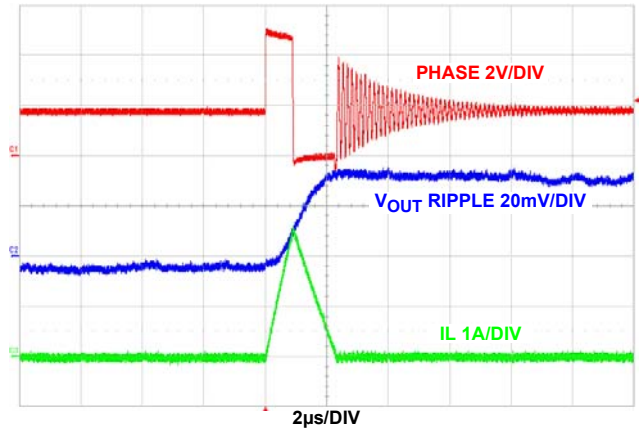

FIGURE 17. STEADY STATE OPERATION AT NO LOAD (PFM)

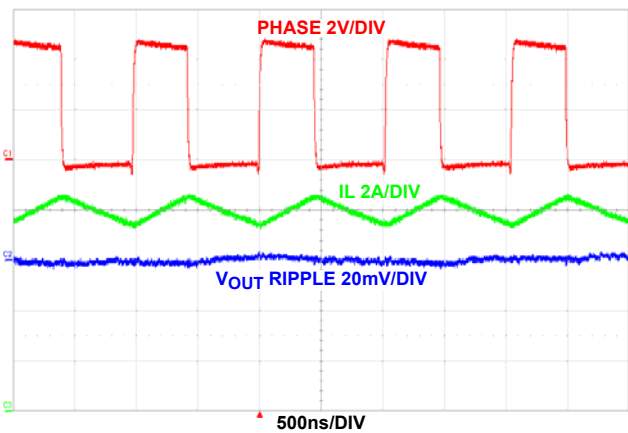

FIGURE 18. STEADY STATE OPERATION WITH FULL LOAD

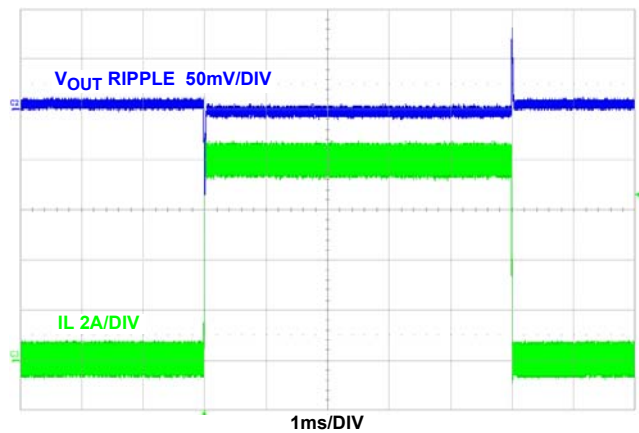

FIGURE 19. LOAD TRANSIENT (PWM)

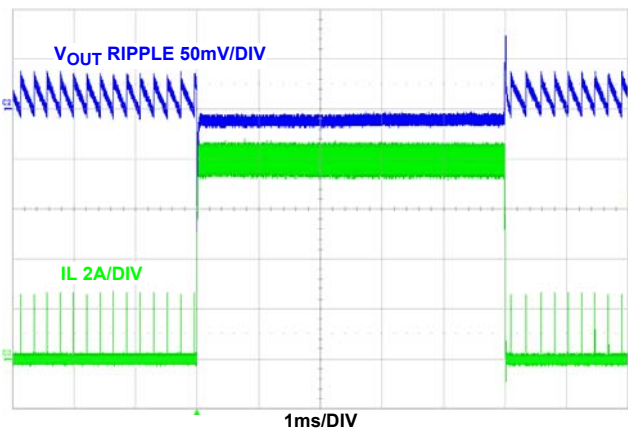

FIGURE 20. LOAD TRANSIENT (PFM)

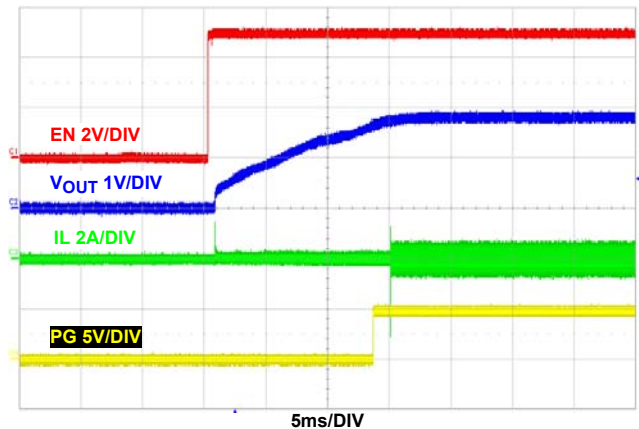

FIGURE 21. SOFT-START WITH NO LOAD (PWM)

Typical Operating Performance

Unless otherwise noted, operating conditions are: $T_A = +25^\circ\text{C}$, $V_{IN} = 5\text{V}$, $EN = 3.3\text{V}$, $SYN\text{CIN} = V_{IN}$, $L = 1\mu\text{H}$, $C_1 = 2 \times 22\mu\text{F}$, $C_2 = 4 \times 22\mu\text{F}$, $V_{OUT} = 1.8\text{V}$, $I_{OUT} = 0\text{A to } 8\text{A}$. (Continued)

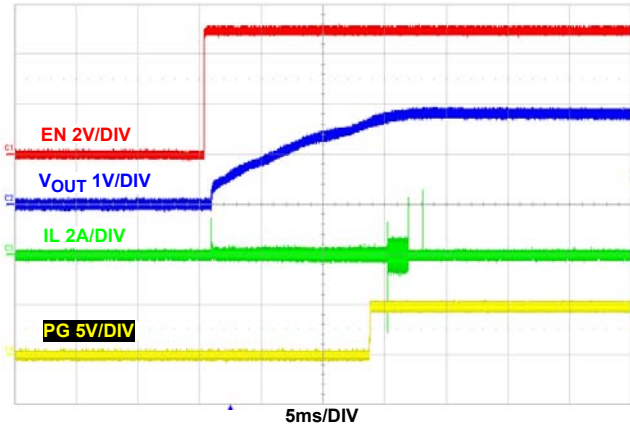

FIGURE 22. SOFT-START AT NO LOAD (PFM)

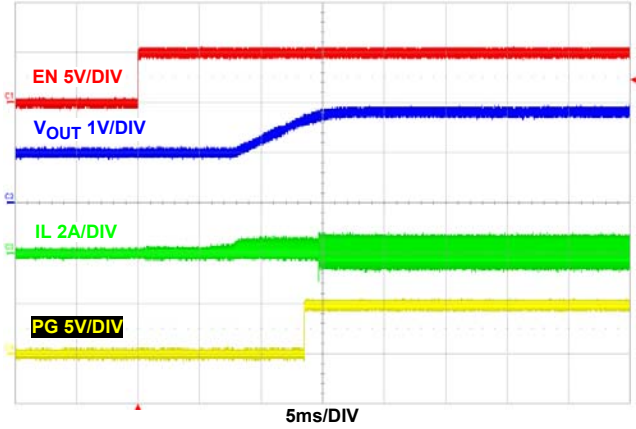

FIGURE 23. SOFT-START WITH PREBIASED 1V

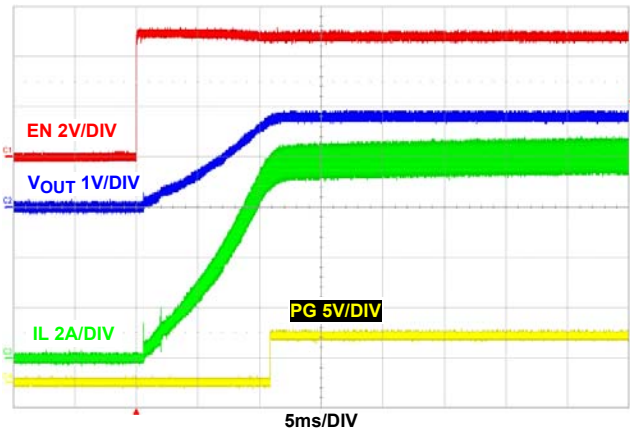

FIGURE 24. SOFT-START AT FULL LOAD

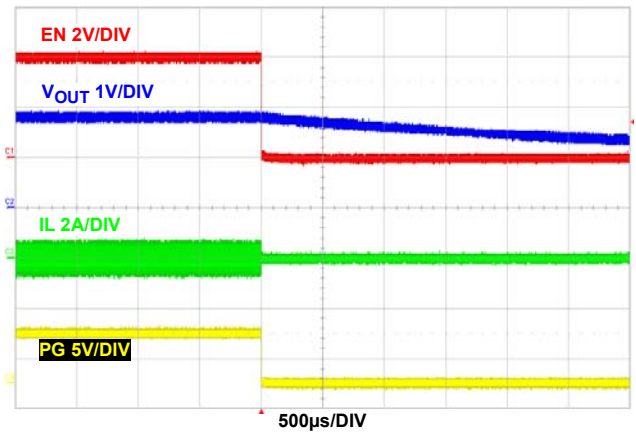

FIGURE 25. SOFT-DISCHARGE SHUTDOWN

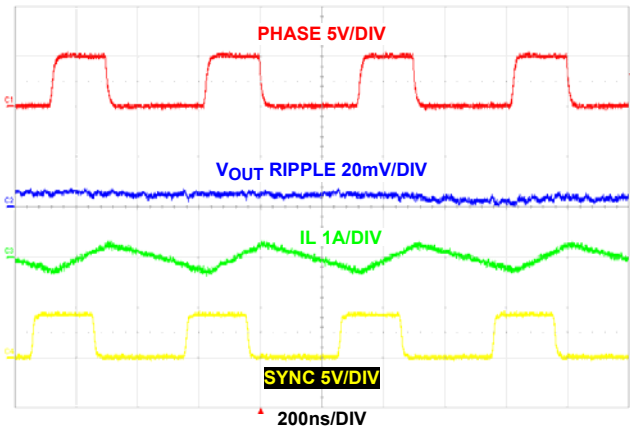

FIGURE 26. STEADY STATE OPERATION AT NO LOAD WITH FREQUENCY = 2MHz

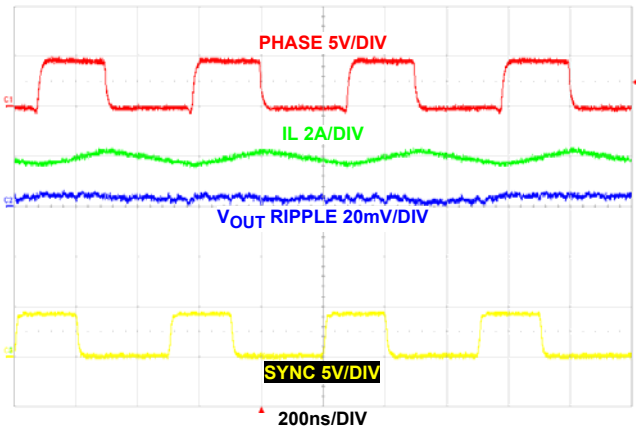

FIGURE 27. STEADY STATE OPERATION AT FULL LOAD WITH FREQUENCY = 2MHz

Typical Operating Performance

Unless otherwise noted, operating conditions are: $T_A = +25^\circ\text{C}$, $V_{IN} = 5\text{V}$, $EN = 3.3\text{V}$, $SYNC_{IN} = V_{IN}$, $L = 1\mu\text{H}$, $C_1 = 2 \times 22\mu\text{F}$, $C_2 = 4 \times 22\mu\text{F}$, $V_{OUT} = 1.8\text{V}$, $I_{OUT} = 0\text{A to } 8\text{A}$. (Continued)

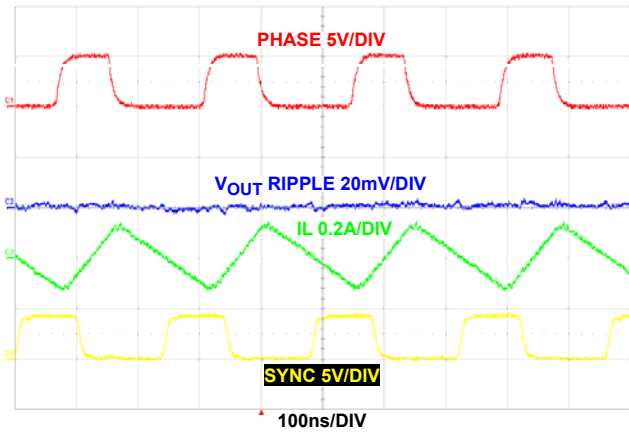

FIGURE 28. STEADY STATE OPERATION AT NO LOAD WITH FREQUENCY = 4MHz

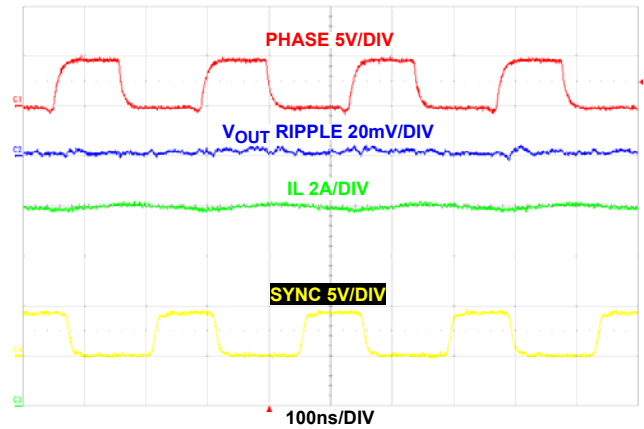

FIGURE 29. STEADY STATE OPERATION AT FULL LOAD (PWM) WITH FREQUENCY = 4MHz

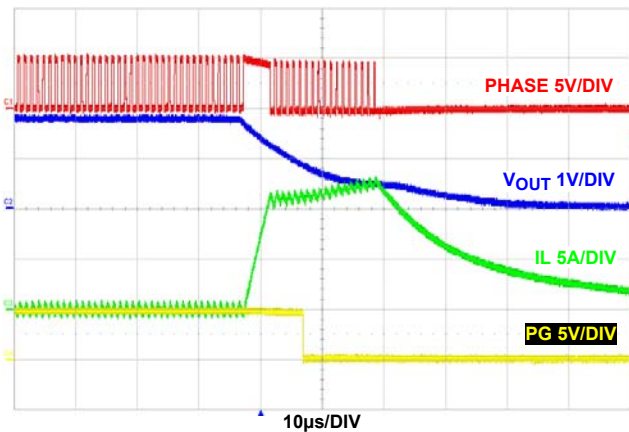

FIGURE 30. OUTPUT SHORT-CIRCUIT

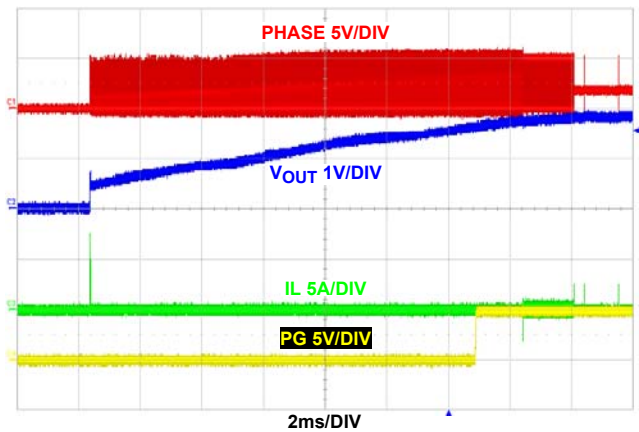

FIGURE 31. OUTPUT SHORT-CIRCUIT RECOVERY

Theory of Operation

The ISL8018 is a step-down switching regulator optimized for battery-powered handheld applications. The regulator operates at 1MHz fixed default switching frequency when FS is connected to VIN. By connecting a resistor from FS to SGND, the operating frequency may be adjusted from 500kHz to 4MHz. Unless forced and PWM is chosen (SYNCIN pulled HI), the regulator will allow PFM operation and reduce switching frequency at light loading to maximize efficiency. In this condition, no load quiescent is typically 70µA.

PWM Control Scheme

Pulling the SYNCIN high (>0.8V) forces the converter into PWM mode, regardless of output current. The ISL8018 employs the current-mode Pulse Width Modulation (PWM) control scheme for fast transient response and pulse-by-pulse current limiting. Figure 3 shows the block diagram. The current loop consists of the oscillator, the PWM comparator, current sensing circuit and the slope compensation for the current loop stability. The slope compensation is 360mV/Ts. Current sense resistance, R_t , is typically 0.11V/A. The control reference for the current loop comes from the error amplifier's (EAMP) output.

The PWM operation is initialized by the clock from the oscillator. The P-channel MOSFET is turned on at the beginning of a PWM cycle and the current in the MOSFET starts to ramp up. When the sum of the current amplifier CSA and the slope compensation reaches the control reference of the current loop, the PWM comparator EAMP output sends a signal to the PWM logic to turn off the P-FET and turn on the N-channel MOSFET. The N-FET stays on until the end of the PWM cycle. Figure 32 shows the typical operating waveforms during the PWM operation. The dotted lines illustrate the sum of the slope compensation ramp and the current-sense amplifier's CSA output.

The output voltage is regulated by controlling the V_{EAMP} voltage to the current loop. The bandgap circuit outputs a 0.6V reference voltage to the voltage loop. The feedback signal comes from the VFB pin. The soft-start block only affects the operation during the start-up and will be discussed separately. The error amplifier is a transconductance amplifier that converts the voltage error signal to a current output. The voltage loop is internally compensated

with the 55pF and 168kΩ RC network. The maximum EAMP voltage output is precisely clamped to 2.4V.

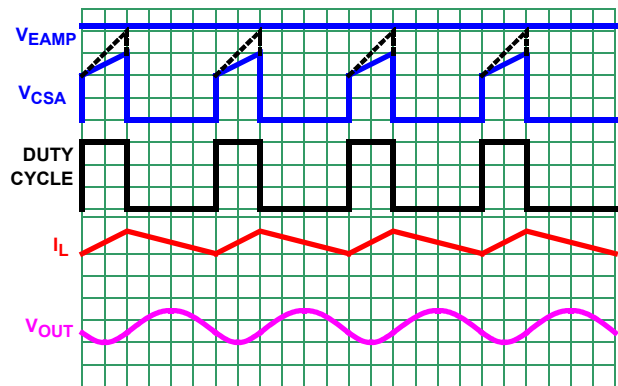

FIGURE 32. PWM OPERATION WAVEFORMS

Skip Mode

Pulling the SYNCIN pin LO (<0.4V) forces the converter into PFM mode. The ISL8018 enters a pulse-skipping mode at light load to minimize the switching loss by reducing the switching frequency. Figure 33 illustrates the Skip mode operation. A zero-cross sensing circuit shown in Figure 3 monitors the N-FET current for zero crossing. When 8 consecutive cycles of the inductor current crossing zero are detected, the regulator enters the Skip mode. During the eight detecting cycles, the current in the inductor is allowed to become negative. The counter is reset to zero when the current in any cycle does not cross zero.

Once the Skip mode is entered, the pulse modulation starts being controlled by the skip comparator shown in Figure 33. Each pulse cycle is still synchronized by the PWM clock. The P-FET is turned on at the clock's rising edge and turned off when the output is higher than 1.5% of the nominal regulation or when its current reaches the peak skip current limit value. Then the inductor current is discharging to 0A and stays at zero. The internal clock is disabled. The output voltage reduces gradually due to the load current discharging the output capacitor. When the output voltage drops to the nominal voltage, the P-FET will be turned on again at the rising edge of the internal clock as it repeats the previous operations.

The regulator resumes normal PWM mode operation when the output voltage drops 1.5% below the nominal voltage.

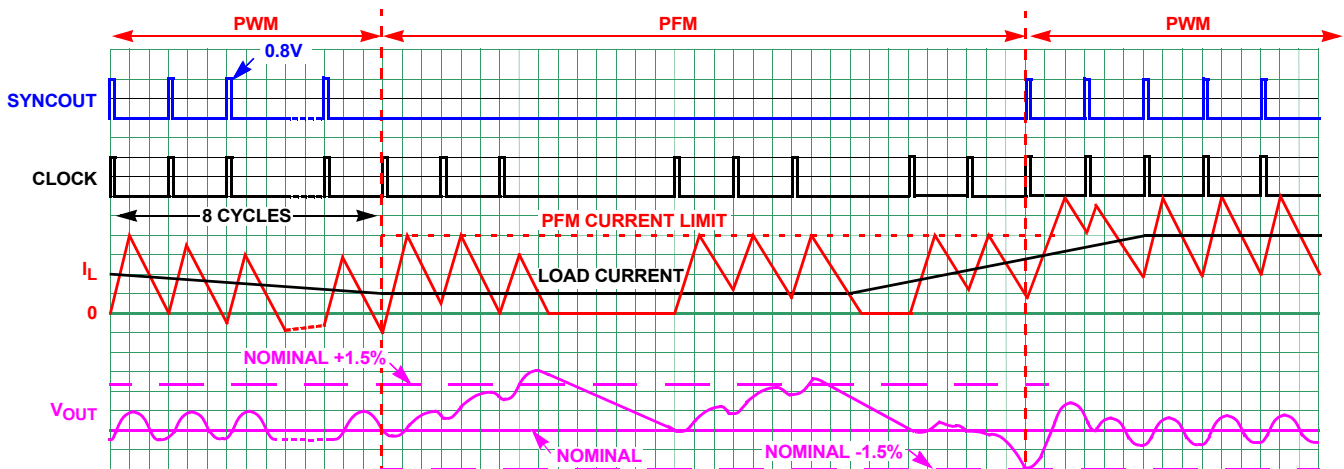

FIGURE 33. SKIP MODE OPERATION WAVEFORMS

Frequency Adjust

The frequency of operation is fixed at 1MHz and internal compensation when FS is tied to VIN. Adjustable frequency ranges from 500kHz to 4MHz via a simple resistor connecting FS to SGND according to [Equation 1](#):

$$R_T[\text{k}\Omega] = \frac{220 \cdot 10^3}{f_{\text{OSC}}[\text{kHz}] - 14} \quad (\text{EQ. 1})$$

[Figure 34](#) is a graph of the measured Frequency vs RT for a VIN of 2.7V and 5.5V.

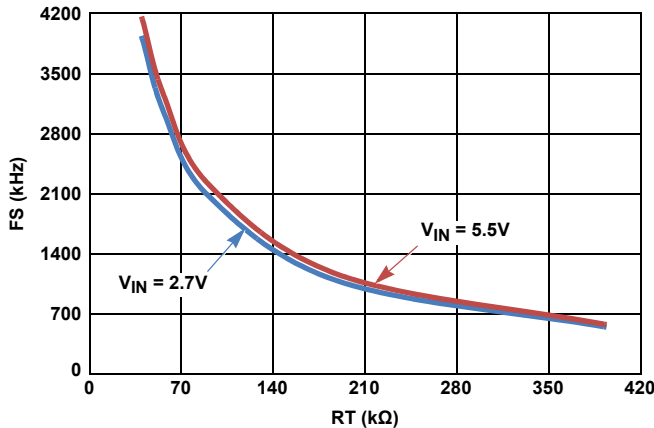

FIGURE 34. FREQUENCY vs RT

Synchronization Control

The ISL8018 can be synchronized from 500kHz to 4MHz by an external signal applied to the SYNCIN pin. SYNCIN frequency should be greater than 50% of internal clock frequency. The rising edge on the SYNCIN triggers the rising edge of the PHASE pulse. Make sure that the minimum on time of the PHASE node is greater than 140ns.

SYNCOUT is a 250μA current pulse signal that is triggered on the rising edge of the clock or SYNCIN signal (whichever is greater in frequency). This drives other ISL8018s and avoids system beat frequency effects. See [Figure 35](#) for more detail. The current pulse is terminated and SYNCOUT is discharged to 0V after 0.8V threshold is reached. SYNCOUT is 0V if the regulator operates at light PFM load.

To implement time shifting between the master circuit to the slave, it is recommended to add a capacitor, C₁₃ as shown in [Figure 3 on page 5](#). The time delay from SYNCOUT_Master to SYNCIN_Slave as shown in [Figure 3 on page 5](#) is calculated in pF using [Equation 2](#):

$$C_{13}(\text{pF}) = 0.333 \cdot (t - 20)(\text{ns}) \quad (\text{EQ. 2})$$

Where t is the desired time shift between the master and the slave circuits in ns. Care must be taken to include PCB parasitic capacitance of ~3pF to 10pF.

The maximum should be limited to 1/f_{SW}-100ns to insure that SYNCOUT has enough time to discharge before the next cycle starts.

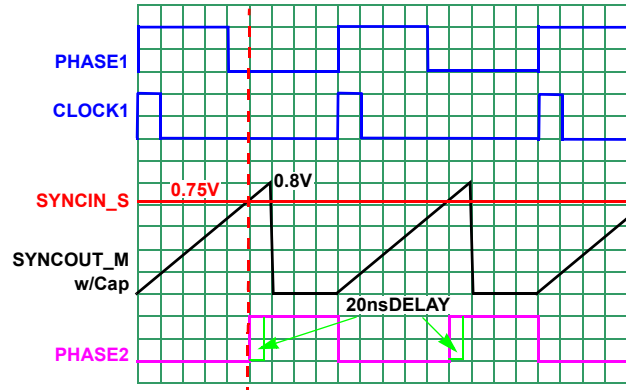

FIGURE 35. SYNCHRONIZATION WAVEFORMS

[Figure 36](#) is a graph of the master to slave phase shift vs SYNCOUT capacitance for 1MHz switching operation.

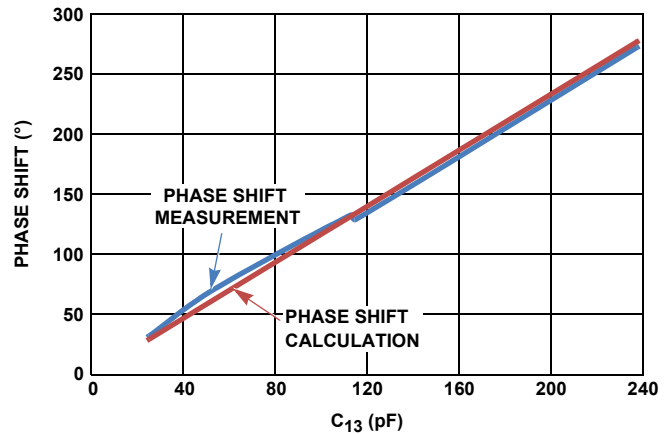

FIGURE 36. PHASE SHIFT vs CAPACITANCE

Overcurrent Protection

The overcurrent protection is realized by monitoring the CSA output with the OCP comparator, as shown in [Figure 3 on page 5](#). The current sensing circuit has a gain of 0.11V/A, from the P-FET current to the CSA output. When the CSA output reaches a threshold set by ISET, the OCP comparator is tripped to turn off the P-FET immediately. See ["Analog Specifications" on page 6](#) of the OCP threshold for various ISET configurations. The overcurrent function protects the switching converter from a shorted output by monitoring the current flowing through the upper MOSFET.

Upon detection of an overcurrent condition, the upper MOSFET will be immediately turned off and will not be turned on again until the next switching cycle. Upon detection of the initial overcurrent condition, the overcurrent fault counter is set to 1. If, on the subsequent cycle, another overcurrent condition is detected, the OC fault counter will be incremented. If there are 17 sequential OC fault detections, the regulator will be shut down under an overcurrent fault condition. An overcurrent fault condition will result in the regulator attempting to restart in a hiccup mode within the delay of eight soft-start periods. At the end of the eight soft-start wait period, the fault counters are reset and soft-start is attempted again. If the overcurrent condition goes away during the delay of eight soft-start periods, the output will resume back into regulation point after hiccup mode expires. When an

overcurrent condition happens at low V_{IN} , it is recommended to add more input capacitance, so the valley of V_{IN} is always above UVLO to maintain normal operation.

Negative Current Protection

Similar to overcurrent, the negative current protection is realized by monitoring the current across the low-side N-FET, as shown in [Figure 3 on page 5](#). When the valley point of the inductor current reaches $-3A$ for 4 consecutive cycles, both P-FET and N-FET are off. The 100Ω in parallel to the N-FET will activate discharging the output into regulation. The control will begin to switch when output is within regulation. The regulator will be in PFM for $20\mu s$ before switching to PWM if necessary.

PG

PG is an open-drain output of a window comparator that continuously monitors the buck regulator output voltage. PG is actively held low when EN is low and during the buck regulator soft-start period. After 1ms delay of the soft-start period, PG becomes high impedance as long as the output voltage is within nominal regulation voltage set by VFB. When VFB drops 15% below or raises 0.8V above the nominal regulation voltage, the ISL8018 pulls PG low. Any fault condition forces PG low until the fault condition is cleared by attempts to soft-start. For logic level output voltages, connect an external pull-up resistor, R_1 , between PG and V_{IN} . A $100k\Omega$ resistor works well in most applications.

UVLO

When the input voltage is below the Undervoltage Lockout (UVLO) threshold, the regulator is disabled.

Soft Start-Up

The soft start-up reduces the inrush current during the start-up. The soft-start block outputs a ramp reference to the input of the error amplifier. This voltage ramp limits the inductor current as well as the output voltage speed so that the output voltage rises in a controlled fashion. When VFB is less than 0.1V at the beginning of the soft-start, the switching frequency is reduced to 200kHz so that the output can start up smoothly at light load condition. During soft-start, the IC operates in the Skip mode to support prebiased output condition.

Tie SS to SGND for an internal soft-start of approximately 1ms. Connect a capacitor from SS to SGND to adjust the soft-start time. This capacitor, along with an internal $1.8\mu A$ current source sets the soft-start interval of the converter, t_{SS} .

$$C_{SS}[\mu F] = 3.33 \cdot t_{SS}[s] \quad (\text{EQ. 3})$$

C_{SS} must be less than 33nF to insure proper soft-start reset after fault condition. **For proper use, do not prebias output voltage more than regulation point.**

[Figure 37](#) is a comparison between measured and calculated output soft-start time versus C_{SS} capacitance.

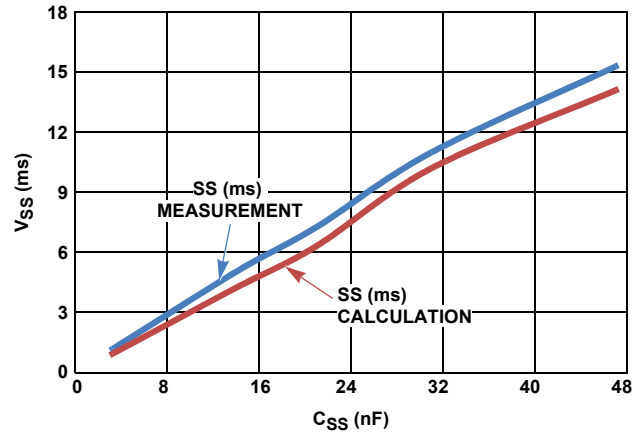

FIGURE 37. SOFT-START TIME vs C_{SS}

Enable

The enable (EN) input allows the user to control the turning on or off of the regulator for purposes such as power-up sequencing. When the regulator is enabled, there is typically a $600\mu s$ delay for waking up the bandgap reference and then the soft start-up begins.

Discharge Mode (Soft-Stop)

When a transition to shutdown mode occurs or the V_{IN} UVLO is set, the outputs discharge to GND through an internal 100Ω switch. The discharge mode is disabled if SS is tied to an external capacitor.

Power MOSFETs

The power MOSFETs are optimized for best efficiency. The ON-resistance for the P-FET is typically $31m\Omega$ and the ON-resistance for the N-FET is typically $19m\Omega$.

100% Duty Cycle

The ISL8018 features 100% duty cycle operation to maximize the battery life. When the battery voltage drops to a level that the ISL8018 can no longer maintain the regulation at the output, the regulator completely turns on the P-FET. The maximum dropout voltage under the 100% duty cycle operation is the product of the load current and the ON-resistance of the P-FET.

Thermal Shutdown

The ISL8018 has built-in thermal protection. When the internal temperature reaches $+150^\circ C$, the regulator is completely shut down. As the temperature drops to $+125^\circ C$, the ISL8018 resumes operation by stepping through the soft-start.

Power Derating Characteristics

To prevent the regulator from exceeding the maximum junction temperature, some thermal analysis is required. The temperature rise is given by [Equation 4](#):

$$T_{RISE} = (PD)(\theta_{JA}) \quad (\text{EQ. 4})$$

Where PD is the power dissipated by the regulator and θ_{JA} is the thermal resistance from the junction of the die to the ambient temperature. The junction temperature, T_J , is given by [Equation 5](#):

$$T_J = (T_A + T_{RISE}) \quad (\text{EQ. 5})$$

Where T_A is the ambient temperature. For the TQFN package, the θ_{JA} is 42 ($^{\circ}\text{C}/\text{W}$).

The actual junction temperature should not exceed the absolute maximum junction temperature of +125 $^{\circ}\text{C}$ when considering the thermal design.

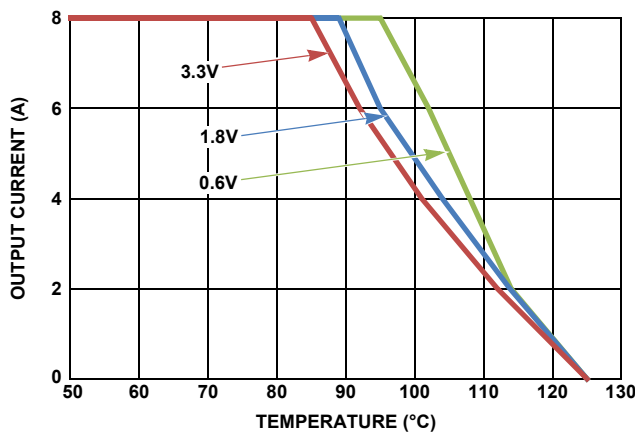

FIGURE 38. DERATING CURVE vs TEMPERATURE

Applications Information

Output Inductor and Capacitor Selection

To consider steady state and transient operations, ISL8018 typically uses a 1 μH output inductor. The higher or lower inductor value can be used to optimize the total converter system performance. For example, for higher output voltage 3.3V application, in order to decrease the inductor current ripple and output voltage ripple, the output inductor value can be increased. It is recommended to set the ripple inductor current approximately 30% of the maximum output current for optimized performance. The inductor ripple current can be expressed as shown in [Equation 6](#):

$$\Delta I = \frac{V_O \cdot \left(1 - \frac{V_O}{V_{IN}}\right)}{L \cdot f_{SW}} \quad (\text{EQ. 6})$$

The inductor's saturation current rating needs to be at least larger than the peak current. The ISL8018 protects the typical peak current of 12A. The saturation current needs to be over 16A for maximum output current application.

The ISL8018 uses an internal compensation network and the output capacitor value is dependent on the output voltage. The ceramic capacitor is recommended to be X5R or X7R.

For high or low output voltage applications, use external compensation for better phase margin.

Output Voltage Selection

The output voltage of the regulator can be programmed via an external resistor divider that is used to scale the output voltage relative to the internal reference voltage and feed it back to the inverting input of the error amplifier (refer to [Figure 2 on page 4](#)).

The output voltage programming resistor, R_2 , will depend on the value chosen for the feedback resistor and the desired output voltage of the regulator. The value for the feedback resistor is typically between 10k Ω and 100k Ω , as shown in [Equation 7](#).

$$R_2 = R_3 \left(\frac{V_O}{V_{FB}} - 1 \right) \quad (\text{EQ. 7})$$

If the output voltage desired is 0.6V, then R_3 is left unpopulated and R_2 is shorted. There is a leakage current from VIN to PHASE. It is recommended to preload the output with 10 μA minimum. Capacitance, C_3 , may be added to improve transient performance. A good starting point for C_3 can be determined by choosing a value that provides an 80kHz corner frequency with R_2 .

VSET marginally adjusts VFB according to the [“Analog Specifications” on page 6](#).

[Figure 39](#) is the recommended minimum output voltage setting vs operational frequency in order to avoid the minimum on-time specification.

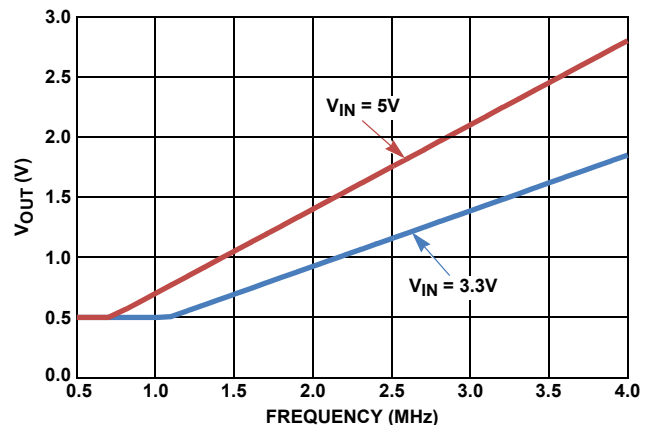

FIGURE 39. MINIMUM V_{OUT} vs FREQUENCY

Input Capacitor Selection

The main functions for the input capacitor are to provide decoupling of the parasitic inductance and a filtering function to prevent the switching current flowing back to the battery rail. At least two 22 μF X5R or X7R ceramic capacitors are a good starting point for the input capacitor selection.

Loop Compensation Design

When there is an external resistor connected from FS to SGND, the COMP pin is active for external loop compensation. The ISL8018 uses constant frequency peak current mode control architecture to achieve fast loop transient response. An accurate current sensing pilot device in parallel with the upper MOSFET is used for peak current control signal and overcurrent protection. The inductor is not considered as a state variable since its peak current is constant and the system becomes a single order system. It is much easier to design a type II compensator to stabilize the loop than to implement voltage mode control. Peak current mode control has an inherent input voltage feed-forward function to achieve good line regulation. Figure 40 shows the small signal model of the synchronous buck regulator.

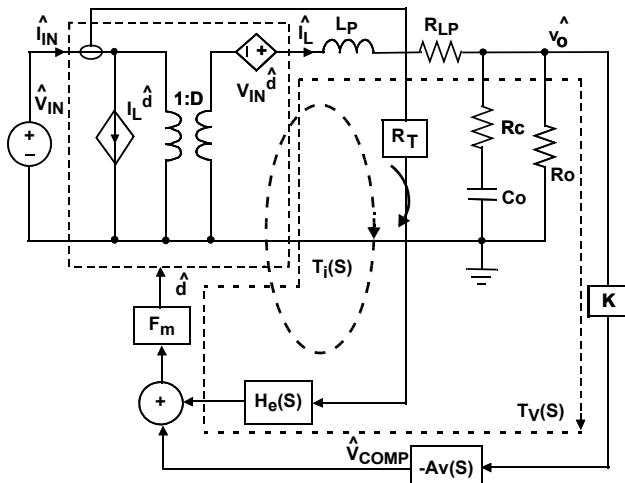

FIGURE 40. SMALL SIGNAL MODEL OF SYNCHRONOUS BUCK REGULATOR

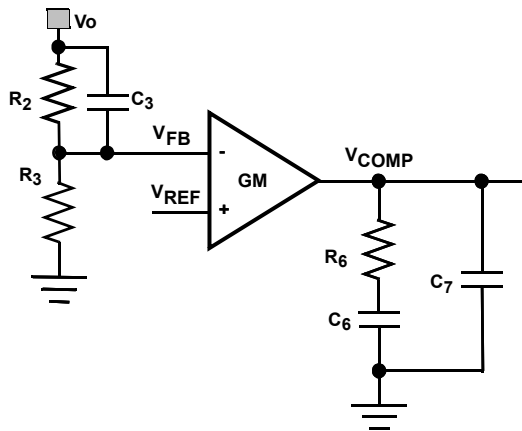

FIGURE 41. TYPE II COMPENSATOR

Figure 41 shows the type II compensator and its transfer function is expressed as shown in Equation 8:

$$A_v(S) = \frac{\hat{v}_{comp}}{V_{FB}} = \frac{GM \cdot R_3}{(C_6 + C_7) \cdot (R_2 + R_3)} \frac{\left(1 + \frac{S}{\omega_{cz1}}\right) \left(1 + \frac{S}{\omega_{cz2}}\right)}{S \left(1 + \frac{S}{\omega_{cp1}}\right) \left(1 + \frac{S}{\omega_{cp2}}\right)} \quad (EQ. 8)$$

Where

$$\omega_{cz1} = \frac{1}{R_6 C_6}, \quad \omega_{cz2} = \frac{1}{R_2 C_3}, \quad \omega_{cp1} = \frac{C_6 + C_7}{R_6 C_6 C_7}, \quad \omega_{cp2} = \frac{R_2 + R_3}{C_3 R_2 R_3}$$

Compensator design goal:

High DC gain

Choose loop bandwidth f_c less than 100kHz

Gain margin: >10dB

Phase margin: >40°

The compensator design procedure is as follows:

The loop gain at crossover frequency of f_c has a unity gain. Therefore, the compensator resistance R_6 is determined by Equation 9.

$$R_6 = \frac{2\pi f_c V_o C_o R_t}{GM \cdot V_{FB}} = 5.76 \times 10^3 \cdot f_c V_o C_o \quad (EQ. 9)$$

Where GM is the sum of the transconductance, g_m , of the voltage error amplifier in each phase. Compensator capacitor C_6 is then given by Equation 10.

$$C_6 = \frac{R_o C_o}{R_6} = \frac{V_o C_o}{I_o R_6}, C_7 = \max\left(\frac{R_c C_o}{R_6}, \frac{1}{\pi f_s R_6}\right) \quad (EQ. 10)$$

Put one compensator pole at zero frequency to achieve high DC gain, and put another compensator pole at either ESR zero frequency or half switching frequency, whichever is lower in Equation 10. An optional zero can boost the phase margin. ω_{cz2} is a zero due to R_2 and C_3 .

Put compensator zero 2 to 5 times f_c .

$$C_3 = \frac{1}{\pi f_c R_2} \quad (EQ. 11)$$

Example: $V_{IN} = 5V$, $V_O = 1.8V$, $I_O = 8A$, $f_{sw} = 1MHz$, $R_2 = 200k\Omega$, $R_3 = 100k\Omega$, $C_o = 4x22\mu F/3m\Omega$, $L = 1\mu H$, $f_c = 100kHz$, then compensator resistance R_6 :

$$R_6 = 5.76 \times 10^3 \cdot 100kHz \cdot 1.8V \cdot 88\mu F = 91.2k\Omega \quad (EQ. 12)$$

$$C_6 = \frac{1.8V \cdot 88\mu F}{8A \cdot 90.9k\Omega} = 217pF \quad (EQ. 13)$$

$$C_7 = \max\left(\frac{3m\Omega \cdot 88\mu F}{90.9k\Omega}, \frac{1}{\pi \cdot 1MHz(90.9k\Omega)}\right) = (2.9pF, 3.5pF) \quad (EQ. 14)$$

It is also acceptable to use the closest standard values for C_6 and C_7 . There is approximately 3pF parasitic capacitance from V_{COMP} to GND. Therefore, C_7 is optional. Use $C_6 = 220\text{pF}$ and $C_7 = \text{OPEN}$.

$$C_3 = \frac{1}{\pi \cdot 100\text{kHz} \cdot 200\text{k}\Omega} = 16\text{pF} \quad (\text{EQ. 15})$$

Use $C_3 = 15\text{pF}$. Note that C_3 may increase the loop bandwidth from previous estimated value. [Figure 42 on page 19](#) shows the simulated voltage loop gain. It is shown that it has a 125kHz loop bandwidth with a 45° phase margin and 10dB gain margin. It may be more desirable to achieve an increased phase margin. This can be accomplished by lowering R_6 by 20% to 30%.

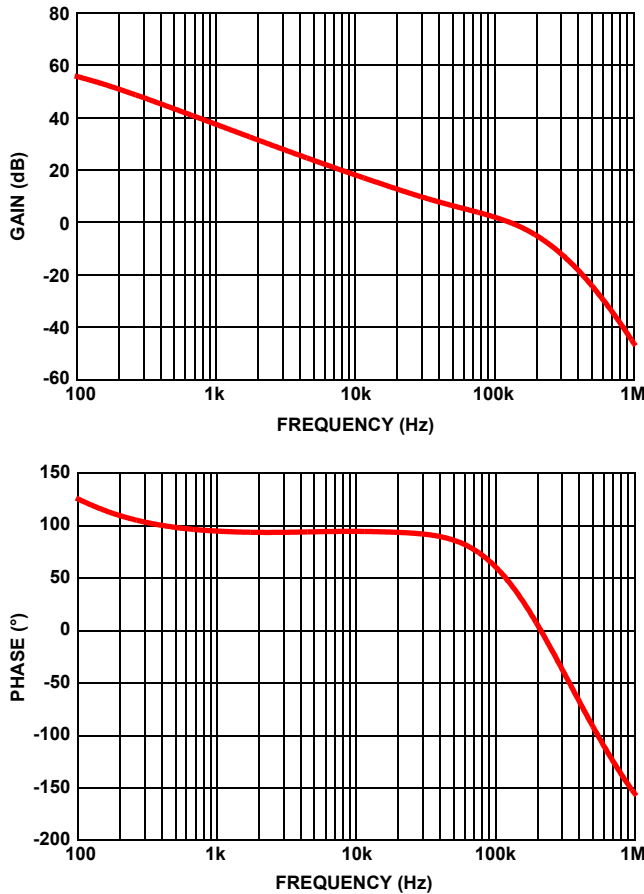

FIGURE 42. SIMULATED LOOP GAIN

PCB Layout Recommendation

The PCB layout is a very important converter design step to make sure the designed converter works well. For ISL8018, the power loop is composed of the output inductor L's, the output capacitor C_{OUT} , the PHASE's pins and the PGND pin. It is necessary to make the power loop as small as possible and the connecting traces among them should be direct, short and wide. The switching node of the converter, the PHASE pins and the traces connected to the node are very noisy, so keep the voltage feedback trace away from these noisy traces. The input capacitor should be placed as close as possible to the VIN pin and the ground of the input and output capacitors should be connected as close as possible. The heat of the IC is mainly dissipated through the thermal pad. Maximizing the copper area connected to the thermal pad is preferable. In addition, a solid ground plane is helpful for better EMI performance. It is recommended to add at least 5 vias ground connection within the pad for the best thermal relief.

Revision History

The revision history provided is for informational purposes only and is believed to be accurate, but not warranted. Please go to web to make sure you have the latest Rev.

DATE	REVISION	CHANGE
September 30, 2015	FN7889.0	Initial Release.

About Intersil

Intersil Corporation is a leading provider of innovative power management and precision analog solutions. The company's products address some of the largest markets within the industrial and infrastructure, mobile computing and high-end consumer markets.

For the most updated datasheet, application notes, related documentation and related parts, please see the respective product information page found at www.intersil.com.

You may report errors or suggestions for improving this datasheet by visiting www.intersil.com/ask.

Reliability reports are also available from our website at www.intersil.com/support

© Copyright Intersil Americas LLC 2015. All Rights Reserved.

All trademarks and registered trademarks are the property of their respective owners.

For additional products, see www.intersil.com/en/products.html

Intersil products are manufactured, assembled and tested utilizing ISO9001 quality systems as noted in the quality certifications found at www.intersil.com/en/support/qualandreliability.html

Intersil products are sold by description only. Intersil may modify the circuit design and/or specifications of products at any time without notice, provided that such modification does not, in Intersil's sole judgment, affect the form, fit or function of the product. Accordingly, the reader is cautioned to verify that datasheets are current before placing orders. Information furnished by Intersil is believed to be accurate and reliable. However, no responsibility is assumed by Intersil or its subsidiaries for its use; nor for any infringements of patents or other rights of third parties which may result from its use. No license is granted by implication or otherwise under any patent or patent rights of Intersil or its subsidiaries.

For information regarding Intersil Corporation and its products, see www.intersil.com

Package Outline Drawing

L20.3x4

20 LEAD QUAD FLAT NO-LEAD PLASTIC PACKAGE

Rev 1, 3/10

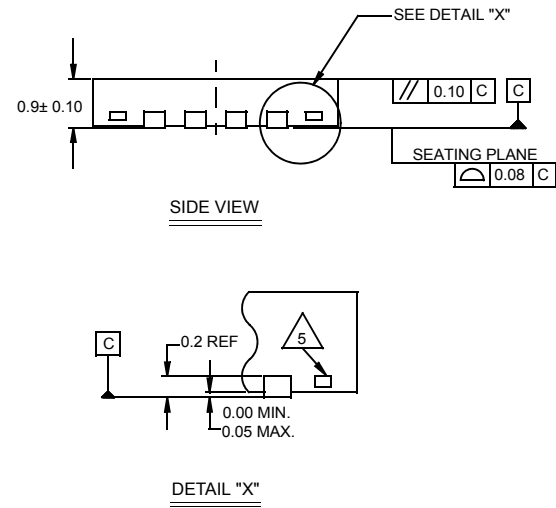
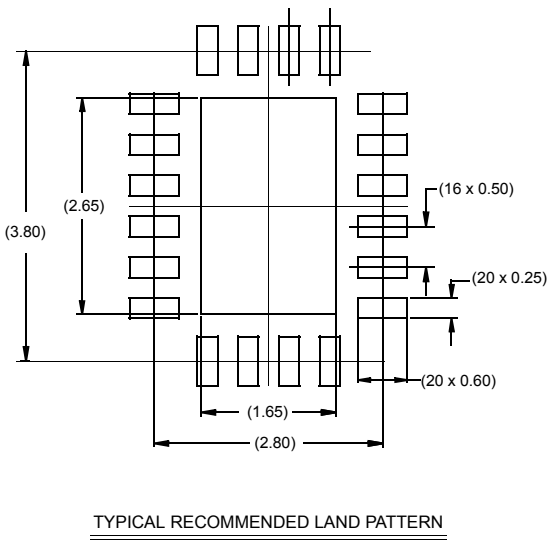
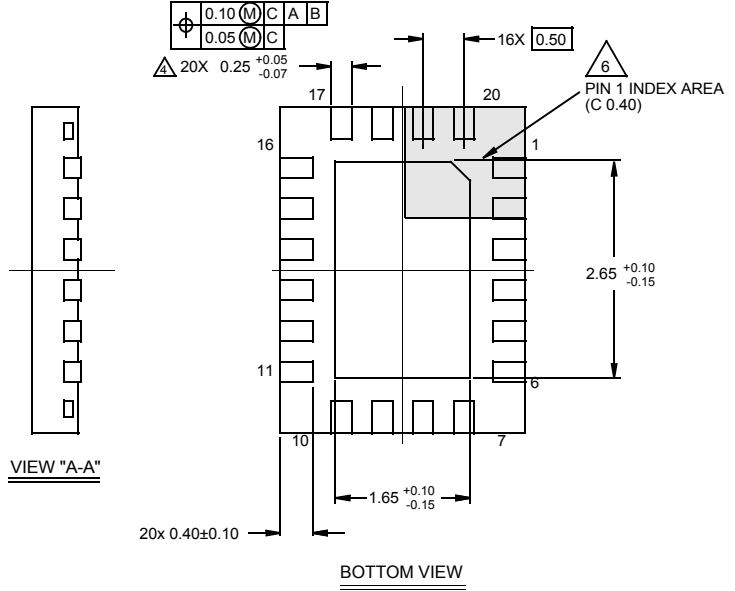
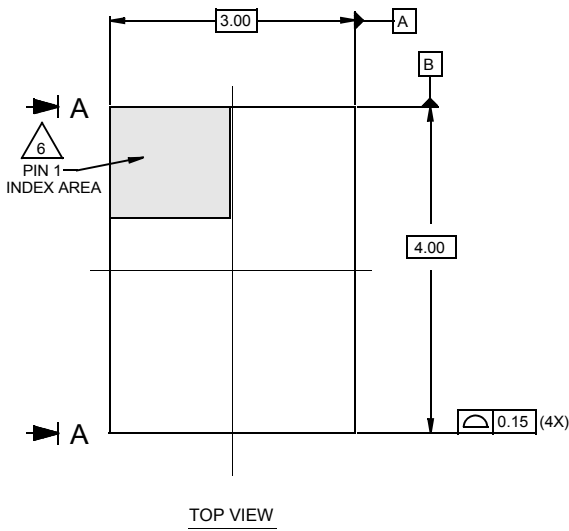

NOTES:

1. Dimensions are in millimeters.
Dimensions in () for Reference Only.
2. Dimensioning and tolerancing conform to AMSE Y14.5m-1994.
3. Unless otherwise specified, tolerance : Decimal ± 0.05
4. Dimension applies to the metallized terminal and is measured between 0.15mm and 0.30mm from the terminal tip.
5. Tiebar shown (if present) is a non-functional feature.
6. The configuration of the pin #1 identifier is optional, but must be located within the zone indicated. The pin #1 identifier may be either a mold or mark feature.