



# SGM41286

## LNB Supply with Tone Repeater/Synthesizer and Programmable Cable Drop Compensation

### GENERAL DESCRIPTION

This device is a high efficiency boost power supply which converts 12V nominal input to 14V/19V nominal output, plus a linear regulation stage for tone signal transmission. It can repeat the external 22kHz tone input symmetrically or synthesize a 22kHz tone signal upon external on/off control.

Pulsing on its EN initiates -1V/+0.4V drop compensation, making it suitable for where external surge absorbing devices are used at the output and for long cable installation.

The SGM41286 is available in Green TDFN-3×3-8L and SOIC-8 (Exposed Pad) packages. It operates over an ambient temperature range of -40°C to +85°C.

### FEATURES

- 7V to 14V Input Voltage
- 500mA 14V/19V Output
- DiSEqC 1.X Compatible
- Programmable -1V/+0.4V Drop Compensation
- High Efficiency Low Head Room Architecture
- Acoustic Noise Free Low Power Operation
- Automatic Tone Repeater or Tone Synthesizer
- LDO Output and Low Out-of-Band Noise
- Internal Short-Safe Over-Current Protection
- Internal Over-Temperature Protection
- 200ms Current Limit Loading Surge Window
- Available in Green TDFN-3×3-8L and SOIC-8 (Exposed Pad) Packages
- -40°C to +85°C Operating Temperature Range

### APPLICATIONS

- STB Satellite Receiver
- TV Satellite Receiver
- PC Card Satellite Receiver

### TYPICAL APPLICATION

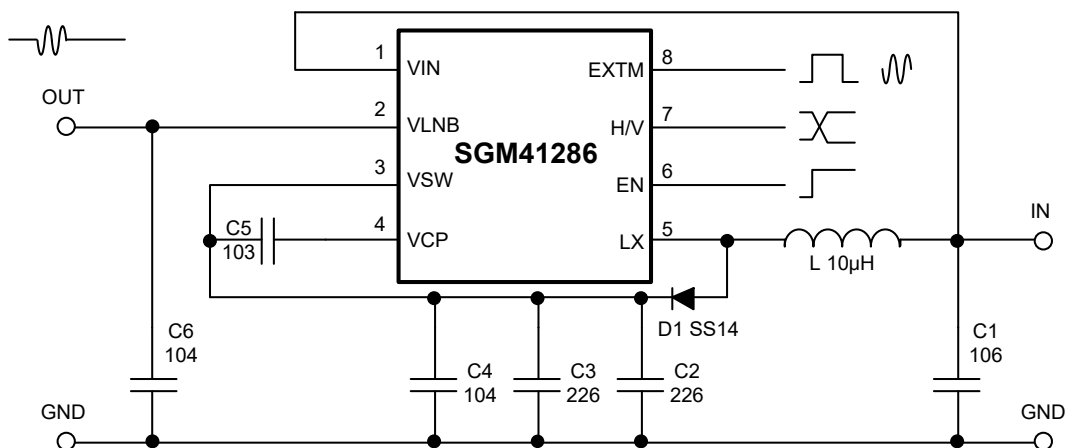

Figure 1. Typical Application Circuit

**PACKAGE/ORDERING INFORMATION**

MODEL	PACKAGE DESCRIPTION	SPECIFIED TEMPERATURE RANGE	ORDERING NUMBER	PACKAGE MARKING	PACKING OPTION
SGM41286	TDFN-3x3-8L	-40°C to +85°C	SGM41286YTDB8G/TR	SGM 41286DB XXXXX	Tape and Reel, 4000
	SOIC-8 (Exposed Pad)	-40°C to +85°C	SGM41286YPS8G/TR	SGM 41286YPS8 XXXXX	Tape and Reel, 4000

**MARKING INFORMATION**

NOTE: XXXXX = Date Code and Vendor Code.

**XXXXX**

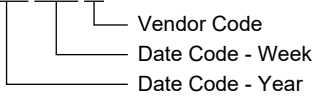

Green (RoHS& HSF): SG Micro Corp defines "Green" to mean Pb-Free (RoHS compatible) and free of halogen substances. If you have additional comments or questions, please contact your SGMICRO representative directly.

**ABSOLUTE MAXIMUM RATINGS**

- V<sub>IN</sub>..... -0.3V to 22.5V
- LX, VCP ..... -0.3V to 30V
- VSW ..... -0.3V to 25.5V
- EN, H/V, EXTM..... -0.3V to 6V
- Junction Temperature ..... +150°C
- Storage Temperature Range..... -65°C to +150°C
- Lead Temperature (Soldering, 10s) ..... +260°C
- ESD Susceptibility
- VLNB to GND, HBM ..... 8000V
- All Rest Pins to GND, HBM..... 4000V
- CDM ..... 2000V
- MM..... 400V
- Surge Immunity, 10µs/700µs, ±Impulse..... 40V

**RECOMMENDED OPERATING CONDITIONS**

- Supply Voltage Range ..... 7V to 14V
- Operating Temperature Range ..... -40°C to +85°C
- Operating Junction Temperature Range ..... -40°C to +125°C

**OVERSTRESS CAUTION**

Stresses beyond those listed in Absolute Maximum Ratings may cause permanent damage to the device. Exposure to absolute maximum rating conditions for extended periods may affect reliability. Functional operation of the device at any conditions beyond those indicated in the Recommended Operating Conditions section is not implied.

**ESD SENSITIVITY CAUTION**

This integrated circuit can be damaged by ESD if you don't pay attention to ESD protection. SGMICRO recommends that all integrated circuits be handled with appropriate precautions. Failure to observe proper handling and installation procedures can cause damage. ESD damage can range from subtle performance degradation to complete device failure. Precision integrated circuits may be more susceptible to damage because very small parametric changes could cause the device not to meet its published specifications.

**DISCLAIMER**

SG Micro Corp reserves the right to make any change in circuit design, or specifications without prior notice.

PIN CONFIGURATIONS

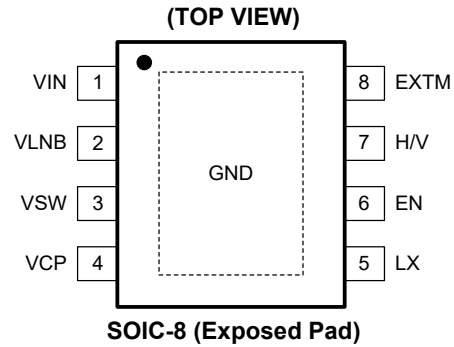
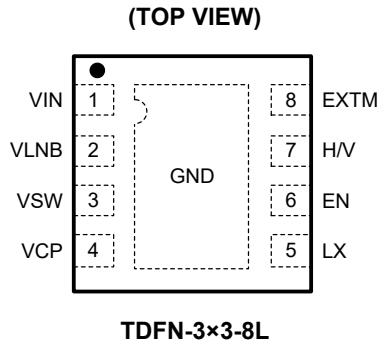

PIN DESCRIPTION

PIN	NAME	TYPE <sup>(1)</sup>	FUNCTION
1	VIN	P	Power Input for Internal Circuit.
2	VLNB	O	Output for LNB Powering. Connect with a 100nF decoupling capacitor.
3	VSW	O	Input for Powering Output Stage.
4	VCP	O	Charge Pump Storage Output for Internal Use. Connect with a 10nF storage capacitor.
5	LX	O	Switch Node of Boost. Connect with one end of a power inductor.
6	EN	I	Enable Input. Pull up to 1.1V ~ 6V logic high to enable chip function.
7	H/V	I	VLNB Output Voltage Selection Input. Pull up to 1.1V ~ 6V logic high for 19V nominal output; pull down or leave it open for 14V nominal output.
8	EXTM	I	External 22kHz Tone Input and Internal Tone Synthesizer Enable Input. If a 22kHz pulse string is applied, symmetric pulse string is sent to VLNB to superpose over its output after first pulse in the string; if input stays high for over 46µs, an internal 22kHz is sent for output.
Exposed Pad	GND	G	Ground of Chip Internal Circuit.

NOTE : 1. P: power, I: input, O: output, G: ground.

## ELECTRICAL CHARACTERISTICS

(VIN = 12V, VEN = 3V, CIN = 10μF, CVSW = 22μF × 2, L = 10μH and Full = -40°C to +85°C, TA = +25°C, unless otherwise noted.)

PARAMETER	SYMBOL	CONDITIONS	TEMP	MIN	TYP	MAX	UNITS
<b>OPERATION CHARACTERISTIC</b>							
Supply Voltage	V <sub>OPM</sub>		Full	7	12	14	V
Under-Voltage Lockout Release Voltage	UVLO <sub>r</sub>	V <sub>IN</sub> rising	+25°C		4.5	4.8	V
Shutdown Supply Current	I <sub>Q</sub>	EN = 0	+25°C		60	80	μA
Operation Supply Current	I <sub>OP</sub>	EN = 1, H/V = 0, I <sub>OUT</sub> = 0mA	+25°C		4	5.5	mA
Boost Switching Frequency	f <sub>swm</sub>	No load	+25°C		22		kHz
Boost Switching Frequency	f <sub>sw1</sub>		+25°C	1.27	1.41	1.55	MHz
VLNB Output Voltage	V14	H/V = 0, I <sub>OUT</sub> = 500mA	+25°C	13.65	14	14.35	V
	V19	H/V = 1, I <sub>OUT</sub> = 500mA	+25°C	18.5	19	19.5	
Power Supply Rejection Ratio	14PSRR1k	1kHz, H/V = 0, V <sub>PP</sub> = 200mV	+25°C		-58		dB
	19PSRR1k	1kHz, H/V = 1, V <sub>PP</sub> = 200mV	+25°C		-50		
Line Regulation	14V <sub>LINEREG</sub>	V <sub>IN</sub> = 11V to 12V, I <sub>OUT</sub> = 500mA, H/V = 0	+25°C		0.01		%V
	19V <sub>LINEREG</sub>	V <sub>IN</sub> = 11V to 12V, I <sub>OUT</sub> = 500mA, H/V = 1	+25°C		0.01		
Linear Regulator Dropout Voltage	V <sub>R<sub>RM</sub></sub>		+25°C		600		mV
Short Circuit Current Limit	I <sub>SHRT</sub>		+25°C		3		A
Over-Current Limit	I <sub>OC</sub>		+25°C		750		mA
Output Current	I <sub>OUT</sub>		+25°C		500		mA
Over-Current Blanking Time	t <sub>OCBLK</sub>		+25°C		186		ms
Over-Current Retry Time	t <sub>RETRY</sub>		+25°C		744		ms
Count of Over-Current Retry Times	C <sub>RETRY</sub>		+25°C		8		–
Line Drop Compensation Voltage	DCV	3 EN pulses	+25°C		-1		V
		4 EN pulses	+25°C		0.4		V
Efficiency (No Tone)	η	H/V = 0, I <sub>OUT</sub> = 500mA	+25°C		89.5		%
		H/V = 1, I <sub>OUT</sub> = 500mA	+25°C		89		
Efficiency (Tone)	η <sub>T</sub>	H/V = 0, I <sub>OUT</sub> = 500mA	+25°C		87.7		%
		H/V = 1, I <sub>OUT</sub> = 500mA	+25°C		87.5		
<b>OVER-TEMPERATURE PROTECTION</b>							
Over-Temperature Shutdown	T <sub>OT</sub>				160		°C
Over-Temperature Protection Hysteresis	T <sub>OTHYS</sub>				30		°C
<b>LOGIC SIGNALS</b>							
Logic High Threshold Level	V <sub>TL</sub>	EN, H/V, EXTM	Full			0.4	V
	V <sub>TH</sub>		Full	1.1			
Logic Input Current	I <sub>EN</sub>		+25°C		0.1	1	μA
H/V Internal Pull-Down Resistance	R <sub>H/V</sub>		+25°C		750		kΩ
EXTM Internal Pull-Down Resistance	R <sub>EXTM</sub>		+25°C		250		kΩ
<b>TIMING</b>							
Power Blanking Time	t <sub>PONBLK</sub>		+25°C		93		ms
Delay Time for Tone Starting after Enable	t <sub>ENDLY</sub>		+25°C		2.9		ms
Delay Time for Output Starting after Enable	t <sub>ONDLY</sub>		+25°C		23.3		ms
Delay Time for Line Drop Out Compensation after End of EN Pulses	t <sub>PROGDLY</sub>		+25°C		2.9		ms
Delay Time for Output Stopping after Disable	t <sub>OFFDLY</sub>		+25°C		23.3		ms

**ELECTRICAL CHARACTERISTICS (continued)**

(VIN = 12V, VEN = 3V, CIN = 10μF, CVSW = 22μF × 2, L = 10μH and Full = -40°C to +85°C, TA = +25°C, unless otherwise noted.)

PARAMETER	SYMBOL	CONDITIONS	TEMP	MIN	TYP	MAX	UNITS
Detection Time for Internal Synthesized Tone Signal	tSYNDLY		+25°C		46		μs
<b>SYNTHESIZED TONE</b>							
Frequency of Internal Synthesized Tone Signal	f22k		+25°C		22		kHz
Tone Amplitude	VPP(TONE)		+25°C		600		mV
Tone Duty Cycle	D		+25°C		50		%
Tone Rise Time	tR		+25°C		5		μs
Tone Fall Time	tF		+25°C		5		μs
<b>EN PULSES</b>							
Minimum On Time between Two EN Pulses	tSH		+25°C		30		μs
Minimum Off Time of EN Pulse	tSL		+25°C		30		μs
Delay Time for Sending EN Pulses after Enable	tE2S		+25°C		2.9		ms
Detection Time for End of EN Pulses	tEOS		+25°C		2.9		ms

**FUNCTIONAL BLOCK DIAGRAM**

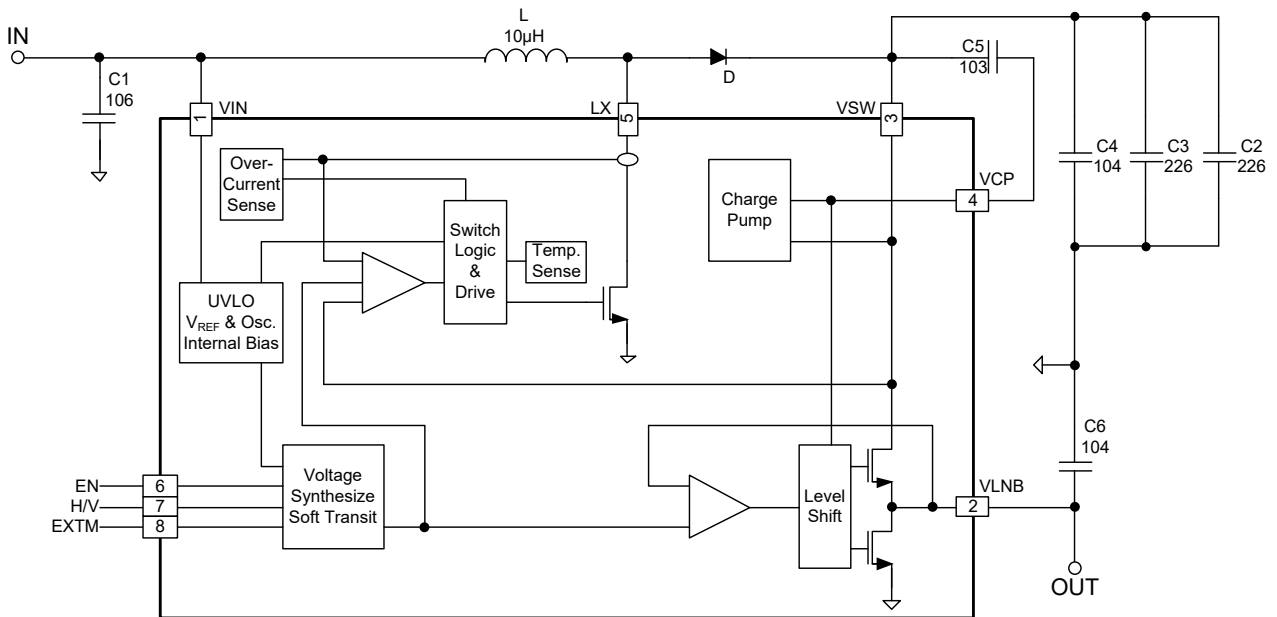

Figure 2. Block Diagram

ESSENTIAL SEQUENCE

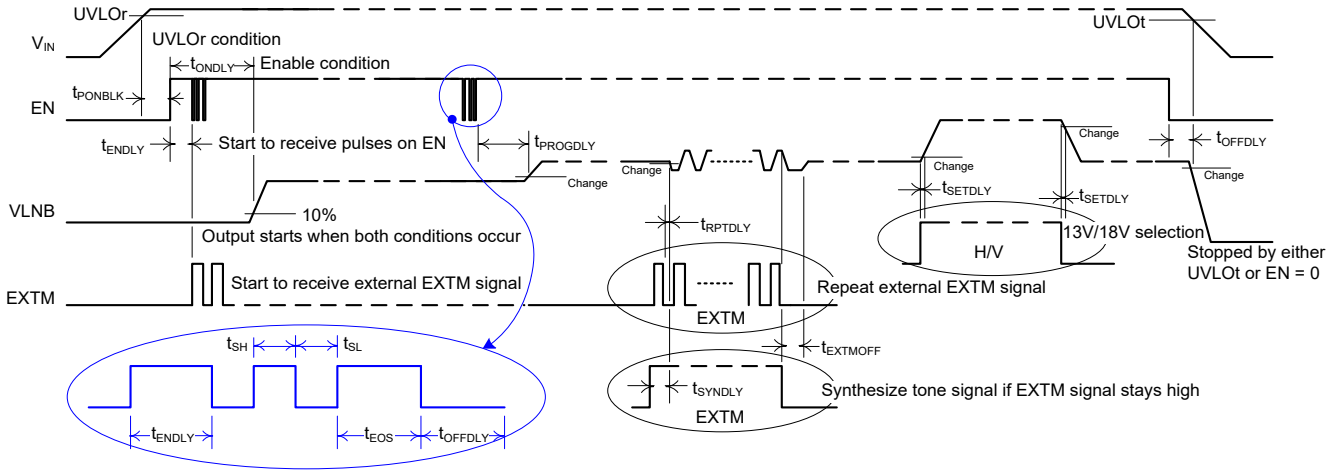
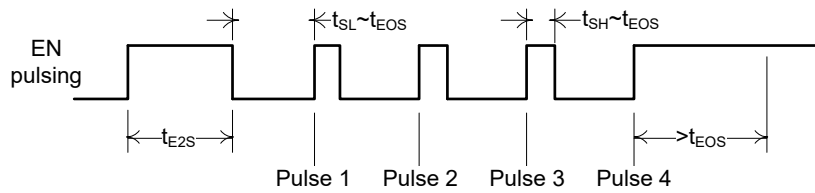

Figure 3. Essential Sequence Timings

CONTROLS AND LOGIC DIAGRAMS

EN Pulsing and Counting



Pulse Counts to Output Status

COUNTS	DESCRIPTION
0	Ignored. Keep its original output status.
1	Ignored. Keep its original status.
2	Reset to no drop compensation status.
3	Apply -1V drop compensation to the normal output voltage.
4	Apply +0.4V drop compensation to the normal output voltage.
> 4	Ignored. Keep its original status. Counting overflow is kept until $t_{PROGDLY}$ times out.

EXTM Signal Timing

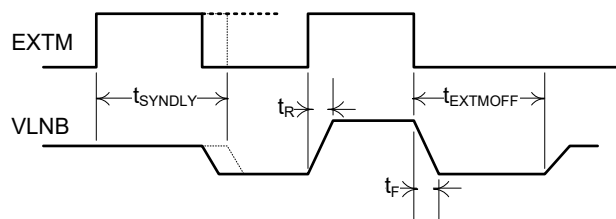

TYPICAL PERFORMANCE CHARACTERISTICS

$V_{IN} = 12V$ ,  $C_{IN} = 10\mu F$ ,  $C_{SW} = 22\mu F \times 2$ ,  $L = 10\mu H$  and  $T_A = +25^\circ C$ , unless otherwise noted.

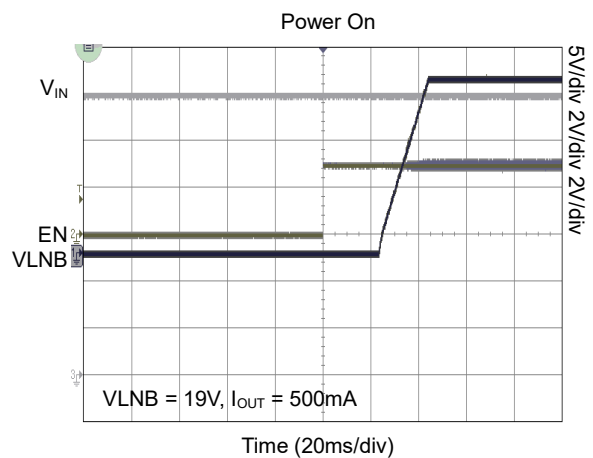
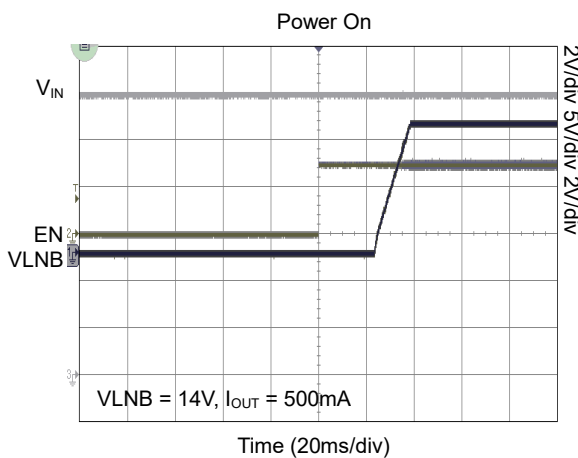
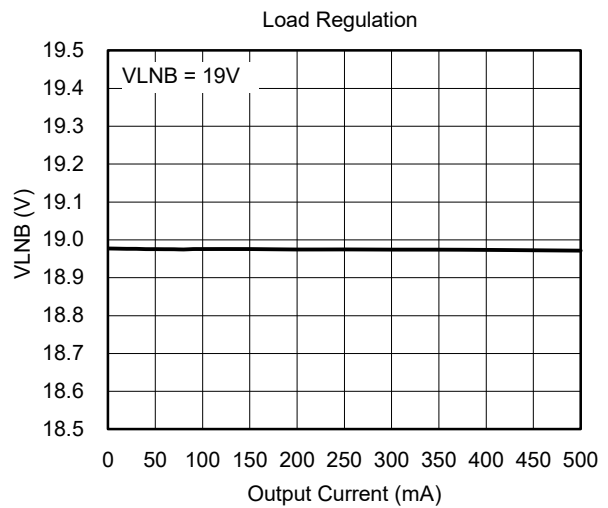
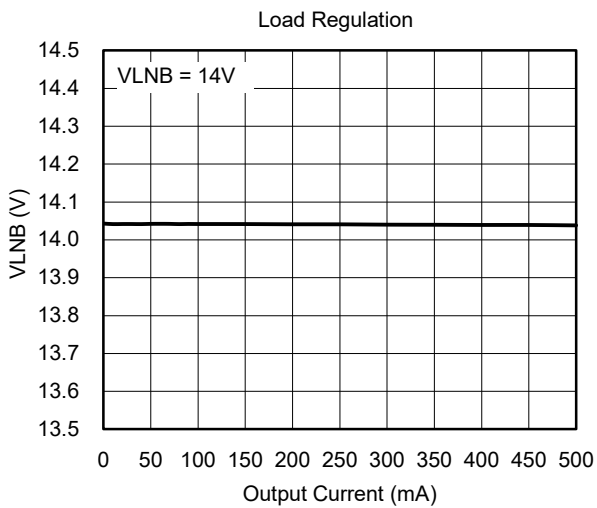
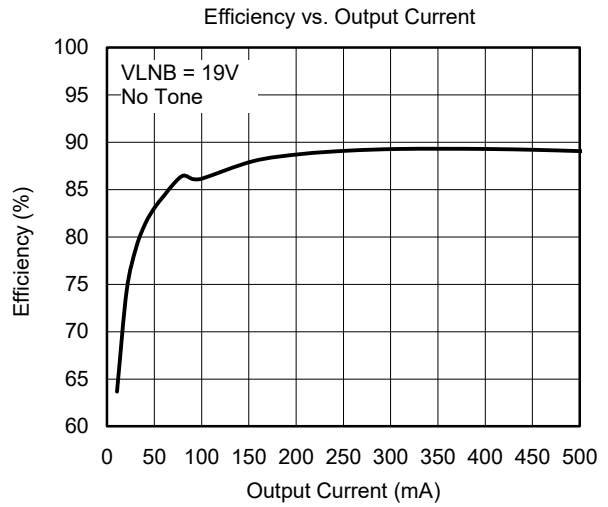
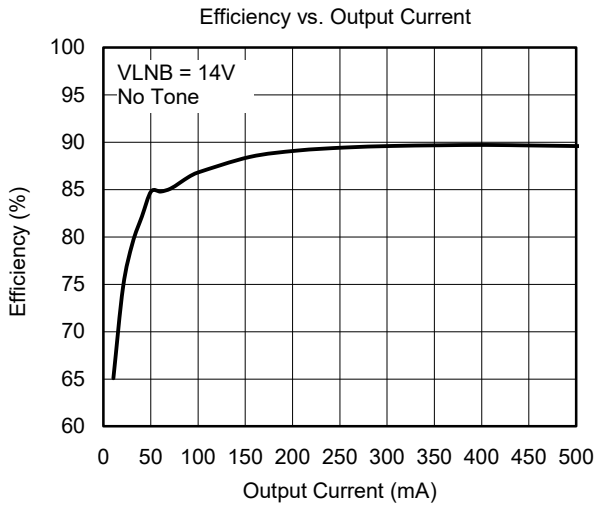

TYPICAL PERFORMANCE CHARACTERISTICS (continued)

$V_{IN} = 12V$ ,  $C_{IN} = 10\mu F$ ,  $C_{SW} = 22\mu F \times 2$ ,  $L = 10\mu H$  and  $T_A = +25^\circ C$ , unless otherwise noted.

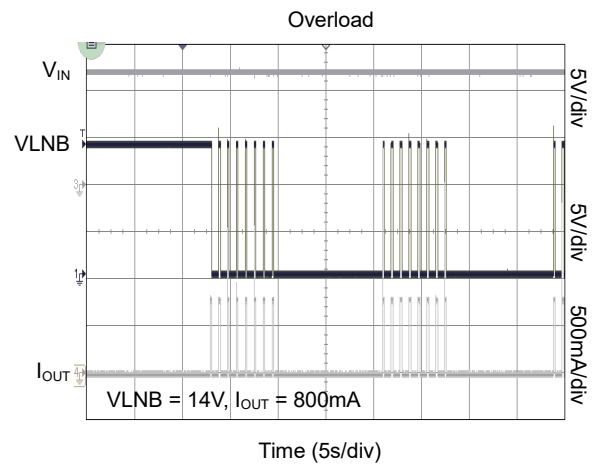
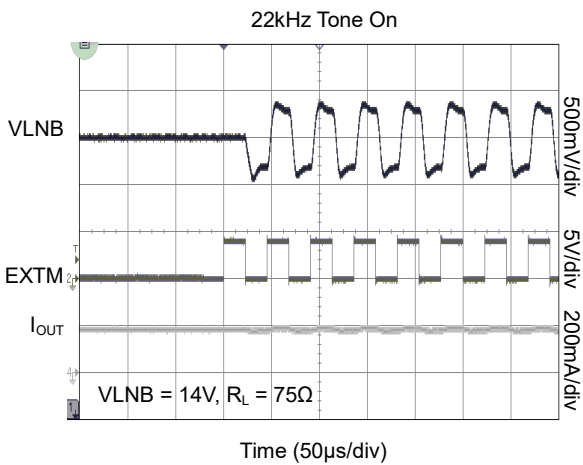
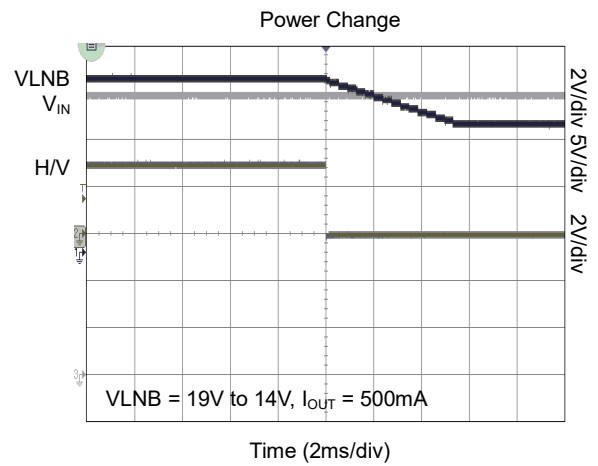
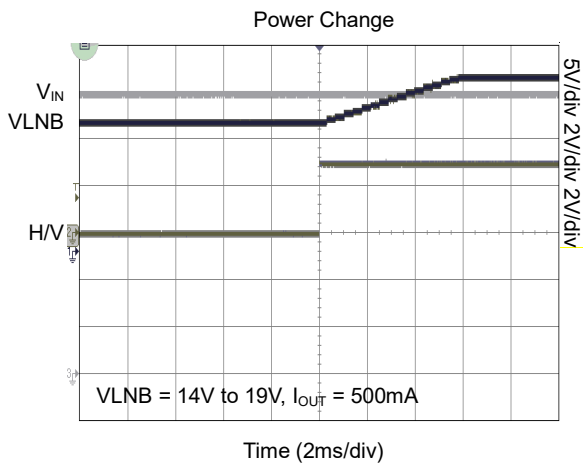
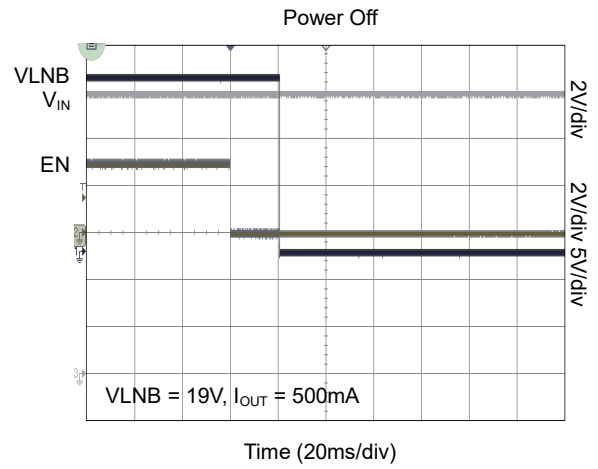
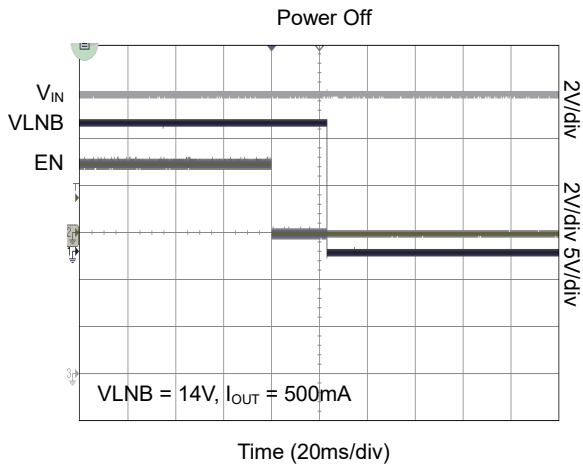



**FUNCTION, OPERATION AND APPLICATION**

The SGM41286 cascades a high efficient boost and a linear regulator to generate two selectable 14V/19V output, for powering and controlling the antenna unit. With an internal synthesizer and an embedded controller, the SGM41286 modulates its output voltage, and transmits control signal over the cable, in compliance with the specifications defined in the DiSEqC, the Digital Satellite Equipment Control Bus, in either repeater mode or synthesizer mode.

**Charge Pump**

Generates a supply voltage above the internal tracking regulator output to drive the linear regulator control.

**Overload Handling**

If the LNB output current > 750mA and lasting for 200ms, or output current > 3A and lasting for 30μs, the converter will shut down for 800ms and then retry to start. After 8 retries, the converter will shut down for 12s and then retry again.

**Thermal Protection**

When the junction temperature exceeds +160°C, the part will be shut down. Once the junction temperature is cooled enough, typically +130°C, the part will restart automatically.

**The DiSEqC Levels**

A 22kHz tone signal is superimposed at the LNB output voltage as a carrier for DiSEqC command. This tone signal can be generated by feeding an external 22kHz clock at the EXTM pin. It can also be generated with its internal tone generator gated by control logic. The output stage of the regulator facilitates a push-pull circuit, so even at zero loading the tone at the output is still clear of distortion.

The SGM41286 only has circuit for signal transmission, which satisfies the level DiSEqC 1.X and those backwards.

**Repeater or Synthesizer**

The synthesizer controller circuit in the SGM41286 detects the level change of the EXTM input. When a rising edge is detected, the controller counts the time for an expected falling edge of 22kHz square wave in  $t_{SYNDLY}$ . If the falling does not happen, it steps down the VLNB for about  $V_{PPTONE}/2$ , and then modulates the VLNB with local synthesizer’s 22kHz; if the falling edge

comes within  $t_{SYNDLY}$ , the controller steps down the VLNB output for about  $V_{PPTONE}/2$ , and repeat what is seen at the EXTM input.

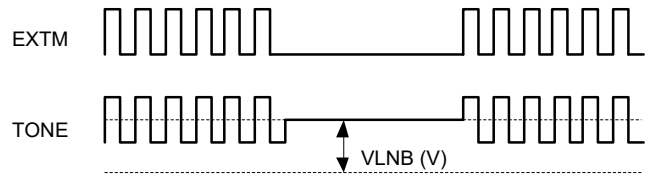

Figure 4. Tone and VLNB

**Layout and Surge Absorbing Recommendations and In-Rush Handling**

The booster works at high frequency, and careful layout is helpful and even critical for assuring the stable operation, smaller ripples and better EMC performance. See Figure 5 for a reference board layout used for the evaluation, which is proven to be good in the SGM41286’s development test.

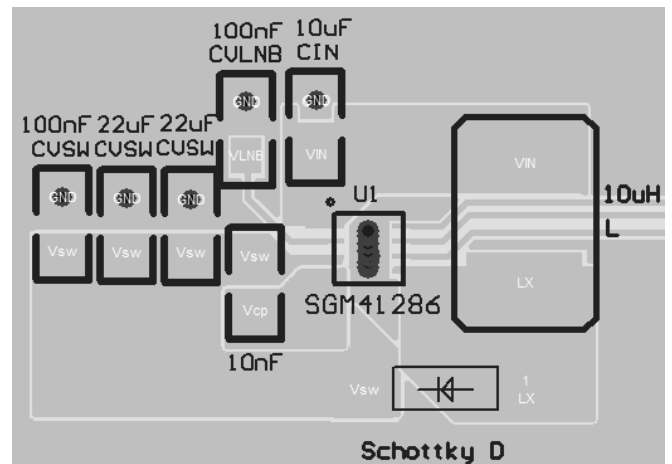

Figure 5. Reference Board Layout

Surging contributes to the operation down-time. Absorbing circuit like the SGM40700 in addition to passive splitter and absorbing circuit is recommended for protection at both the in-door unit and the outdoor unit. See Figure 6 for a reference circuit with surge absorbing and splitter.

If excessive motor spin-stalling current in-rush happens, the SGM41286 stops output for a short while and resumes instantly for a few times. If the over-current does exist after instant retries, the SGM41286 turns into longer interval retries for safety concern.

FUNCTION, OPERATION AND APPLICATION (continued)

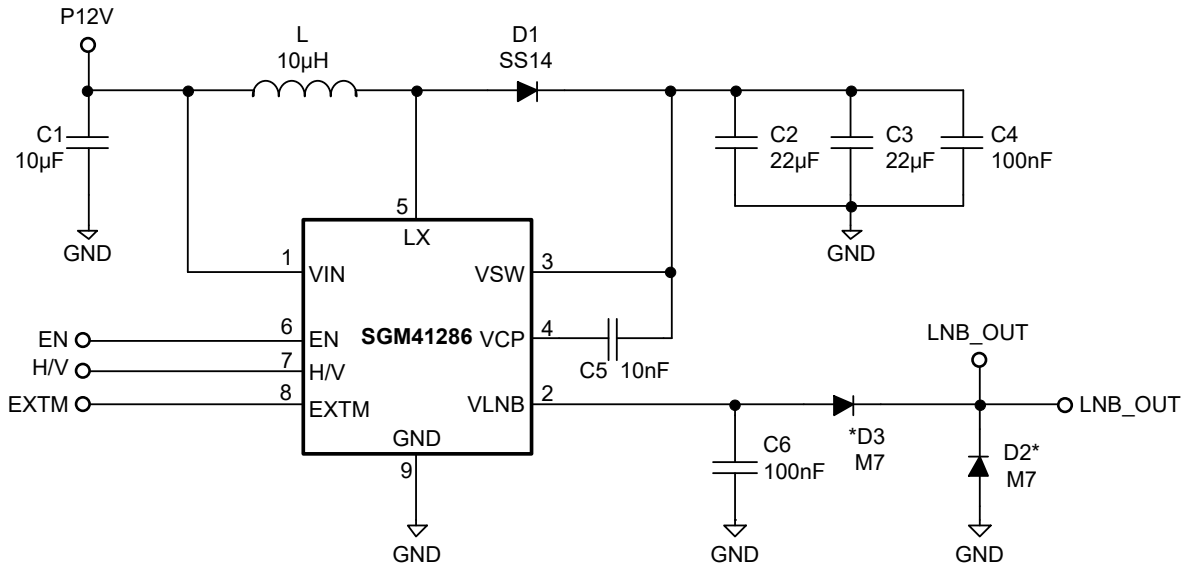

Figure 6. A Reference Circuit with Surge Absorbing Circuit and Splitter

\*D2, D3 for high voltage surge test

REVISION HISTORY

NOTE: Page numbers for previous revisions may differ from page numbers in the current version.

Revision	Page
<b>MAY 2019 – REV.A.1 to REV.A.2</b>	
Updated Absolute Maximum Ratings.....	2
<b>APRIL 2019 – REV.A to REV.A.1</b>	
Updated Absolute Maximum Ratings.....	2
<b>Changes from Original (JULY 2017) to REV.A</b>	
Changed from product preview to production data.....	All

PACKAGE OUTLINE DIMENSIONS

TDFN-3x3-8L

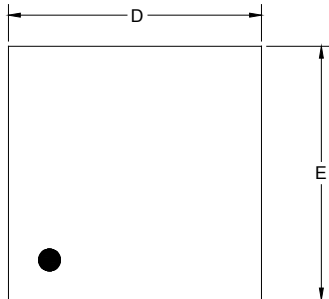

TOP VIEW

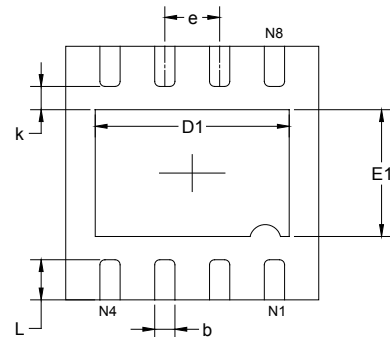

BOTTOM VIEW

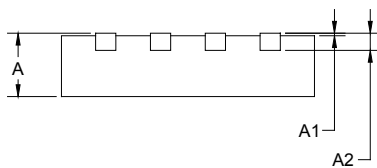

SIDE VIEW

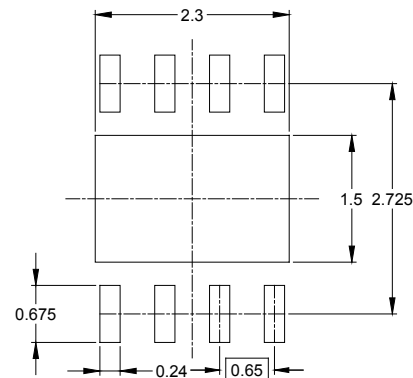

RECOMMENDED LAND PATTERN (Unit: mm)

Symbol	Dimensions In Millimeters		Dimensions In Inches	
	MIN	MAX	MIN	MAX
A	0.700	0.800	0.028	0.031
A1	0.000	0.050	0.000	0.002
A2	0.203 REF		0.008 REF	
D	2.900	3.100	0.114	0.122
D1	2.200	2.400	0.087	0.094
E	2.900	3.100	0.114	0.122
E1	1.400	1.600	0.055	0.063
k	0.200 MIN		0.008 MIN	
b	0.180	0.300	0.007	0.012
e	0.650 TYP		0.026 TYP	
L	0.375	0.575	0.015	0.023

PACKAGE OUTLINE DIMENSIONS

SOIC-8 (Exposed Pad)

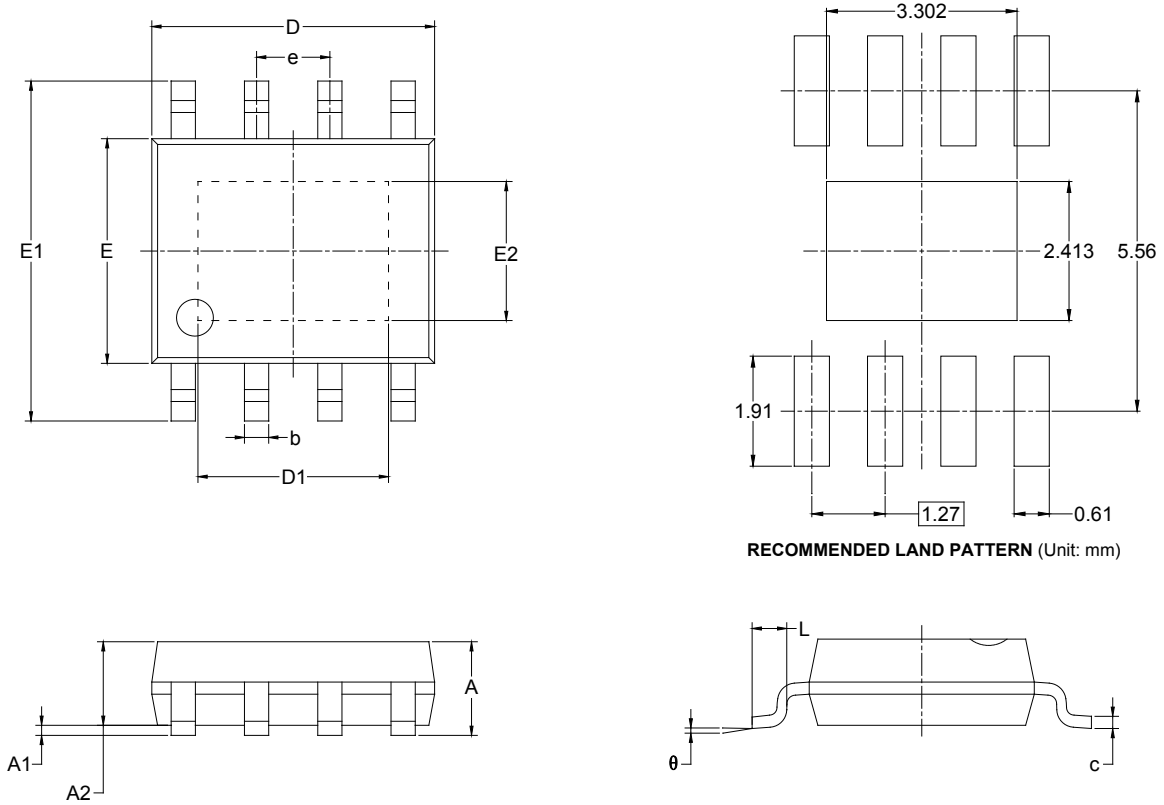

Symbol	Dimensions In Millimeters		Dimensions In Inches	
	MIN	MAX	MIN	MAX
A		1.700		0.067
A1	0.000	0.100	0.000	0.004
A2	1.350	1.550	0.053	0.061
b	0.330	0.510	0.013	0.020
c	0.170	0.250	0.007	0.010
D	4.700	5.100	0.185	0.201
D1	3.202	3.402	0.126	0.134
E	3.800	4.000	0.150	0.157
E1	5.800	6.200	0.228	0.244
E2	2.313	2.513	0.091	0.099
e	1.27 BSC		0.050 BSC	
L	0.400	1.270	0.016	0.050
θ	0°	8°	0°	8°

# PACKAGE INFORMATION

## TAPE AND REEL INFORMATION

### REEL DIMENSIONS



### TAPE DIMENSIONS



NOTE: The picture is only for reference. Please make the object as the standard.

### KEY PARAMETER LIST OF TAPE AND REEL

Package Type	Reel Diameter	Reel Width W1 (mm)	A0 (mm)	B0 (mm)	K0 (mm)	P0 (mm)	P1 (mm)	P2 (mm)	W (mm)	Pin1 Quadrant
TDFN-3×3-8L	13"	12.4	3.35	3.35	1.13	4.0	8.0	2.0	12.0	Q1
SOIC-8 (Exposed Pad)	13"	12.4	6.40	5.40	2.10	4.0	8.0	2.0	12.0	Q1

DD0001

# PACKAGE INFORMATION

## CARTON BOX DIMENSIONS



NOTE: The picture is only for reference. Please make the object as the standard.

## KEY PARAMETER LIST OF CARTON BOX

Reel Type	Length (mm)	Width (mm)	Height (mm)	Pizza/Carton
13"	386	280	370	5

DD0002