

SMBJ Series

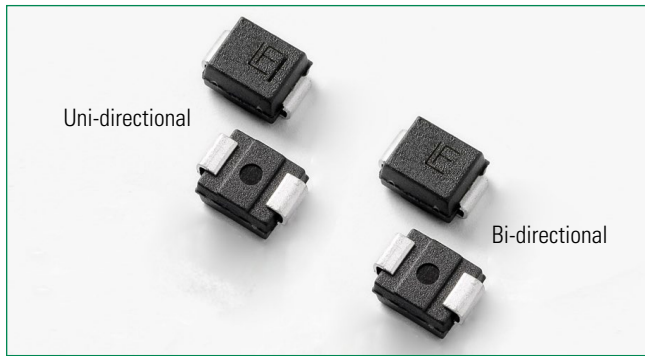

Agency Approvals

| Agency | Agency File Number |
|--------|--------------------|
| | E230531 |

**Maximum Ratings and Thermal Characteristics
(T_A=25°C unless otherwise noted)**

| Parameter | Symbol | Value | Unit |
|---|------------------|------------|------|
| Peak Pulse Power Dissipation(Fig.2) by 10/1000us Test Waveform(Fig.4) (Note 1),(Note 2)-Single Die Parts | P _{PPM} | 600 | W |
| Peak Pulse Power Dissipation(Fig.2) by 10/1000us Test Waveform(Fig.4) (Note 1), (Note 2)-Stacked Die Parts (Note 5) | P _{PPM} | 800 | W |
| Power Dissipation on Infinite Heat Sink at T _L =50°C | P _D | 5.0 | W |
| Peak Forward Surge Current, 8.3ms Single Half Sine Wave (Note 3) | I _{FSM} | 100 | A |
| Maximum Instantaneous Forward Voltage at 50A for Unidirectional Only (Note 4) | V _F | 3.5/5.0 | V |
| Operating Temperature Range | T _J | -65 to 150 | °C |
| Storage Temperature Range | T _{STG} | -65 to 175 | °C |
| Typical Thermal Resistance Junction to Lead | R _{θJL} | 20 | °C/W |
| Typical Thermal Resistance Junction to Ambient | R _{θJA} | 100 | °C/W |

- Notes:**
1. Non-repetitive current pulse, per Fig. 4 and derated above T_J (initial) =25°C per Fig. 3.
 2. Mounted on copper pad area of 0.2x0.2" (5.0 x 5.0mm) to each terminal.
 3. Measured on 8.3ms single half sine wave or equivalent square wave for unidirectional device only, duty cycle=4 per minute maximum.
 4. V_F < 3.5V for single die parts and V_F < 5.0V for stacked-die parts.
 5. For stacked die component details, please refer to part numbers labeled by * in Electrical Characteristics.

Functional Diagram

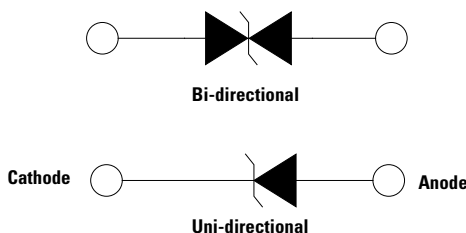

Description

The SMBJ series is designed specifically to protect sensitive electronic equipment from voltage transients induced by lightning and other transient voltage events.

Features

- Excellent clamping capability
- Low incremental surge resistance
- Typical I_R less than 1µA when V_{BR} min>12V
- For surface mounted applications to optimize board space
- Low profile package
- Typical failure mode is short from over-specified voltage or current
- Whisker test is conducted based on JEDEC JESD201A per its table 4a and 4c
- IEC-61000-4-2 ESD 30kV(Air), 30kV (Contact)
- ESD protection of data lines in accordance with IEC 61000-4-2
- EFT protection of data lines in accordance with IEC 61000-4-4
- Built-in strain relief
- Fast response time: typically less than 1.0ps from 0V to VBR min
- 600W peak pulse power capability at 10/1000µs waveform, repetition rate (duty cycles):0.01%
- High temperature to reflow soldering guaranteed: 260°C/30sec
- V_{BR} @ T_J = V_{BR} @25°C x (1 + α T x (T_J - 25)) (α T: Temperature Coefficient, typical value is 0.1%)
- UL Recognized compound meeting flammability classification V-0
- Meet MSL level1, per J-STD-020, LF maximum peak of 260°C
- Matte tin lead-free plated
- Halogen free and RoHS compliant
- Pb-free E3 means 2nd level interconnect is Pb-free and the terminal finish material is tin(Sn) (IPC/ JEDEC J-STD-609A.01)
- UL Recognized to ANSI/UL 497B: Protectors for Data Communications and Fire-Alarm Circuits.

Applications

TVS components are ideal for the protection of I/O Interfaces, V_{CC} bus and other vulnerable circuits used in Telecom, Computer, Industrial and Consumer electronic applications.

Electrical Characteristics (T_A=25°C unless otherwise noted)

| Part Number (Uni) | Part Number (Bi) | Marking | | Reverse Stand off Voltage V _R (Volts) | Breakdown Voltage V _{BR} (Volts) @ I _T | | Test Current I _T (mA) | Maximum Clamping Voltage V _C @ I _{PP} (V) | Maximum Peak Pulse Current I _{PP} (A) | Maximum Reverse Leakage I _R @ V _R (µA) | Maximum Temperature coefficient of V _{BR} (%/C) | Agency Approval  |
|-------------------|------------------|---------|----|--|--|--------|----------------------------------|---|--|--|--|---|
| | | UNI | BI | | MIN | MAX | | | | | | |
| SMBJ5.0A | SMBJ5.0CA | KE | AE | 5.0 | 6.40 | 7.00 | 10 | 9.2 | 65.3 | 800 | 0.041 | X |
| SMBJ6.0A | SMBJ6.0CA | KG | AG | 6.0 | 6.67 | 7.37 | 10 | 10.3 | 58.3 | 800 | 0.046 | X |
| SMBJ6.5A | SMBJ6.5CA | KK | AK | 6.5 | 7.22 | 7.98 | 10 | 11.2 | 53.6 | 500 | 0.052 | X |
| SMBJ7.0A | SMBJ7.0CA | KM | AM | 7.0 | 7.78 | 8.60 | 10 | 12.0 | 50.0 | 200 | 0.058 | X |
| SMBJ7.5A | SMBJ7.5CA | KP | AP | 7.5 | 8.33 | 9.21 | 1 | 12.9 | 46.6 | 100 | 0.061 | X |
| SMBJ8.0A | SMBJ8.0CA | KR | AR | 8.0 | 8.89 | 9.83 | 1 | 13.6 | 44.2 | 50 | 0.064 | X |
| SMBJ8.5A | SMBJ8.5CA | KT | AT | 8.5 | 9.44 | 10.40 | 1 | 14.4 | 41.7 | 20 | 0.066 | X |
| SMBJ9.0A | SMBJ9.0CA | KV | AV | 9.0 | 10.00 | 11.10 | 1 | 15.4 | 39.0 | 10 | 0.069 | X |
| SMBJ10A | SMBJ10CA | KX | AX | 10.0 | 11.10 | 12.30 | 1 | 17.0 | 35.3 | 5 | 0.071 | X |
| SMBJ11A | SMBJ11CA | KZ | AZ | 11.0 | 12.20 | 13.50 | 1 | 18.2 | 33.0 | 1 | 0.074 | X |
| SMBJ12A | SMBJ12CA | LE | BE | 12.0 | 13.30 | 14.70 | 1 | 19.9 | 30.2 | 1 | 0.075 | X |
| SMBJ13A | SMBJ13CA | LG | BG | 13.0 | 14.40 | 15.90 | 1 | 21.5 | 28.0 | 1 | 0.076 | X |
| SMBJ14A | SMBJ14CA | LK | BK | 14.0 | 15.60 | 17.20 | 1 | 23.2 | 25.9 | 1 | 0.080 | X |
| SMBJ15A | SMBJ15CA | LM | BM | 15.0 | 16.70 | 18.50 | 1 | 24.4 | 24.6 | 1 | 0.083 | X |
| SMBJ16A | SMBJ16CA | LP | BP | 16.0 | 17.80 | 19.70 | 1 | 26.0 | 23.1 | 1 | 0.084 | X |
| SMBJ17A | SMBJ17CA | LR | BR | 17.0 | 18.90 | 20.90 | 1 | 27.6 | 21.8 | 1 | 0.085 | X |
| SMBJ18A | SMBJ18CA | LT | BT | 18.0 | 20.00 | 22.10 | 1 | 29.2 | 20.6 | 1 | 0.088 | X |
| SMBJ20A | SMBJ20CA | LV | BV | 20.0 | 22.20 | 24.50 | 1 | 32.4 | 18.6 | 1 | 0.091 | X |
| SMBJ22A | SMBJ22CA | LX | BX | 22.0 | 24.40 | 26.90 | 1 | 35.5 | 16.9 | 1 | 0.092 | X |
| SMBJ24A | SMBJ24CA | LZ | BZ | 24.0 | 26.70 | 29.50 | 1 | 38.9 | 15.5 | 1 | 0.092 | X |
| SMBJ26A | SMBJ26CA | ME | CE | 26.0 | 28.90 | 31.90 | 1 | 42.1 | 14.3 | 1 | 0.093 | X |
| SMBJ28A | SMBJ28CA | MG | CG | 28.0 | 31.10 | 34.40 | 1 | 45.4 | 13.3 | 1 | 0.094 | X |
| SMBJ30A | SMBJ30CA | MK | CK | 30.0 | 33.30 | 36.80 | 1 | 48.4 | 12.4 | 1 | 0.096 | X |
| SMBJ33A | SMBJ33CA | MM | CM | 33.0 | 36.70 | 40.60 | 1 | 53.3 | 11.3 | 1 | 0.097 | X |
| SMBJ36A | SMBJ36CA | MP | CP | 36.0 | 40.00 | 44.20 | 1 | 58.1 | 10.4 | 1 | 0.098 | X |
| SMBJ40A | SMBJ40CA | MR | CR | 40.0 | 44.40 | 49.10 | 1 | 64.5 | 9.3 | 1 | 0.099 | X |
| SMBJ43A | SMBJ43CA | MT | CT | 43.0 | 47.80 | 52.80 | 1 | 69.4 | 8.7 | 1 | 0.100 | X |
| SMBJ45A | SMBJ45CA | MV | CV | 45.0 | 50.00 | 55.30 | 1 | 72.7 | 8.3 | 1 | 0.101 | X |
| SMBJ48A | SMBJ48CA | MX | CX | 48.0 | 53.30 | 58.90 | 1 | 77.4 | 7.8 | 1 | 0.101 | X |
| SMBJ51A | SMBJ51CA | MZ | CZ | 51.0 | 56.70 | 62.70 | 1 | 82.4 | 7.3 | 1 | 0.101 | X |
| SMBJ54A | SMBJ54CA | NE | DE | 54.0 | 60.00 | 66.30 | 1 | 87.1 | 6.9 | 1 | 0.102 | X |
| SMBJ58A | SMBJ58CA | NG | DG | 58.0 | 64.40 | 71.20 | 1 | 93.6 | 6.5 | 1 | 0.103 | X |
| SMBJ60A | SMBJ60CA | NK | DK | 60.0 | 66.70 | 73.70 | 1 | 96.8 | 6.2 | 1 | 0.103 | X |
| SMBJ64A | SMBJ64CA | NM | DM | 64.0 | 71.10 | 78.60 | 1 | 103.0 | 5.9 | 1 | 0.104 | X |
| SMBJ70A | SMBJ70CA | NP | DP | 70.0 | 77.80 | 86.00 | 1 | 113.0 | 5.3 | 1 | 0.105 | X |
| SMBJ75A | SMBJ75CA | NR | DR | 75.0 | 83.30 | 92.10 | 1 | 121.0 | 5.0 | 1 | 0.106 | X |
| SMBJ78A | SMBJ78CA | NT | DT | 78.0 | 86.70 | 95.80 | 1 | 126.0 | 4.8 | 1 | 0.106 | X |
| SMBJ85A | SMBJ85CA | NV | DV | 85.0 | 94.40 | 104.00 | 1 | 137.0 | 4.4 | 1 | 0.106 | X |
| SMBJ90A | SMBJ90CA | NX | DX | 90.0 | 100.00 | 111.00 | 1 | 146.0 | 4.1 | 1 | 0.107 | X |
| SMBJ100A | SMBJ100CA | NZ | DZ | 100.0 | 111.00 | 123.00 | 1 | 162.0 | 3.7 | 1 | 0.107 | X |
| SMBJ110A | SMBJ110CA | PE | EE | 110.0 | 122.00 | 135.00 | 1 | 177.0 | 3.4 | 1 | 0.107 | X |
| SMBJ120A | SMBJ120CA | PG | EG | 120.0 | 133.00 | 147.00 | 1 | 193.0 | 3.1 | 1 | 0.108 | X |
| SMBJ130A | SMBJ130CA | PK | EK | 130.0 | 144.00 | 159.00 | 1 | 209.0 | 2.9 | 1 | 0.108 | X |
| SMBJ150A | SMBJ150CA | PM | EM | 150.0 | 167.00 | 185.00 | 1 | 243.0 | 2.5 | 1 | 0.108 | X |
| SMBJ160A | SMBJ160CA | PP | EP | 160.0 | 178.00 | 197.00 | 1 | 259.0 | 2.3 | 1 | 0.108 | X |
| SMBJ170A | SMBJ170CA | PR | ER | 170.0 | 189.00 | 209.00 | 1 | 275.0 | 2.2 | 1 | 0.108 | X |
| SMBJ180A | SMBJ180CA | PT | ET | 180.0 | 201.00 | 222.00 | 1 | 292.0 | 2.1 | 1 | 0.108 | X |
| SMBJ188A | SMBJ188CA | PB | EB | 188.0 | 209.00 | 231.00 | 1 | 304.0 | 2.0 | 1 | 0.110 | X |
| SMBJ200A | SMBJ200CA | PV | EV | 200.0 | 224.00 | 247.00 | 1 | 324.0 | 1.9 | 1 | 0.110 | X |
| SMBJ220A | SMBJ220CA | PX | EX | 220.0 | 246.00 | 272.00 | 1 | 356.0 | 1.7 | 1 | 0.110 | X |
| SMBJ250A | SMBJ250CA | PZ | EZ | 250.0 | 279.00 | 309.00 | 1 | 405.0 | 1.5 | 1 | 0.110 | X |
| SMBJ300A* | SMBJ300CA* | QE | FE | 300.0 | 335.00 | 371.00 | 1 | 486.0 | 1.7 | 1 | 0.112 | X |
| SMBJ350A* | SMBJ350CA* | QG | FG | 350.0 | 391.00 | 432.00 | 1 | 567.0 | 1.5 | 1 | 0.112 | X |
| SMBJ400A* | SMBJ400CA* | QK | FK | 400.0 | 447.00 | 494.00 | 1 | 648.0 | 1.3 | 1 | 0.112 | X |
| SMBJ440A* | SMBJ440CA* | QM | FM | 440.0 | 492.00 | 543.00 | 1 | 713.0 | 1.1 | 1 | 0.112 | X |

Notes:

For bidirectional type having V_a of 10 volts and less, the I_s limit is double.
 For stack-die parts, use * to label the part number.

I-V Curve Characteristics

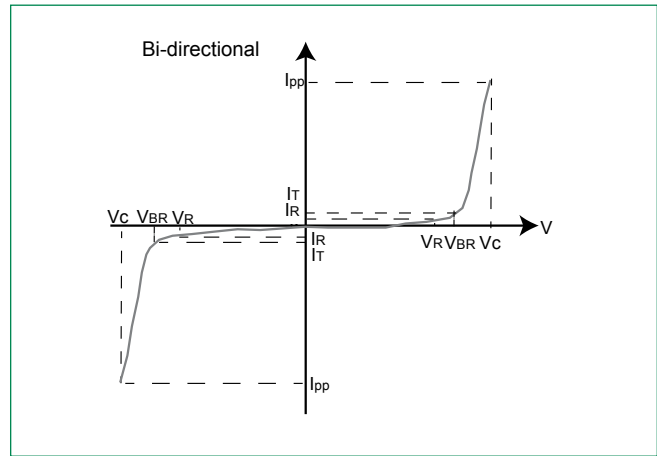
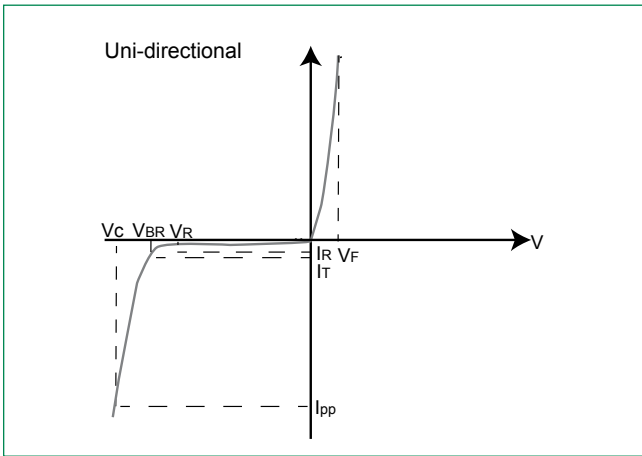

- P_{PPM}** Peak Pulse Power Dissipation – Max power dissipation
- V_s** Stand-off Voltage – Maximum voltage that can be applied to the TVS without operation
- V_{BR}** Breakdown Voltage – Maximum voltage that flows through the TVS at a specified test current (I_T)
- V_C** Clamping Voltage – Peak voltage measured across the TVS at a specified I_{ppm} (peak impulse current)
- I_R** Reverse Leakage Current – Current measured at V_R
- V_F** Forward Voltage Drop for Uni-directional

Ratings and Characteristic Curves (T_A=25°C unless otherwise noted)

Figure 1 - TVS Transients Clamping Waveform

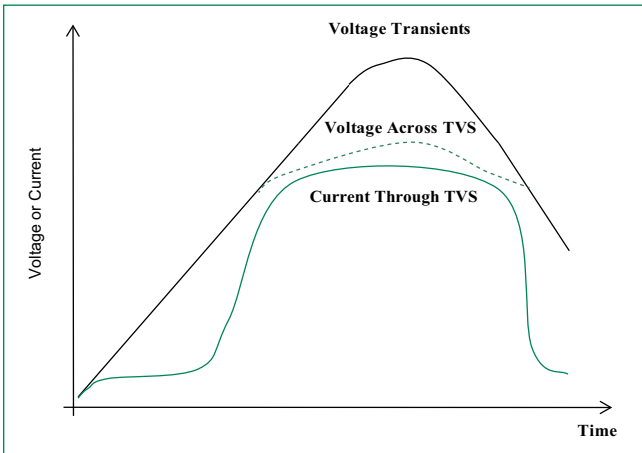
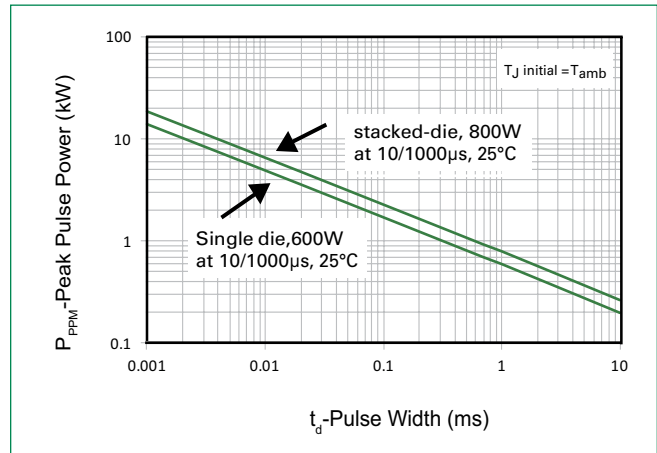

Figure 2 - Peak Pulse Power Rating



Ratings and Characteristic Curves ($T_A=25^\circ\text{C}$ unless otherwise noted) (Continued)

Figure 3 - Peak Pulse Power Derating Curve

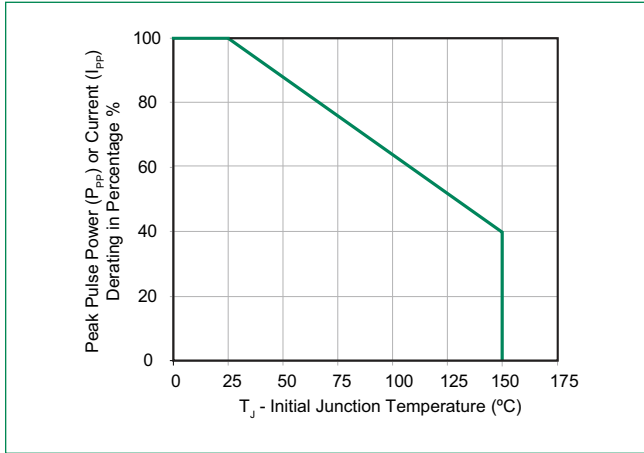

Figure 4 - Pulse Waveform

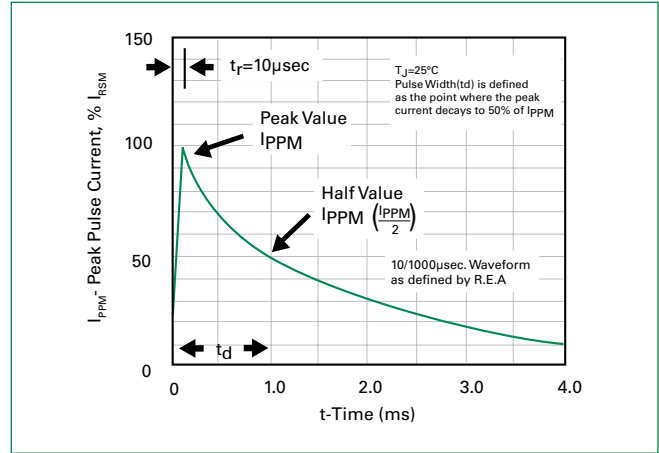

Figure 5 - Typical Junction Capacitance

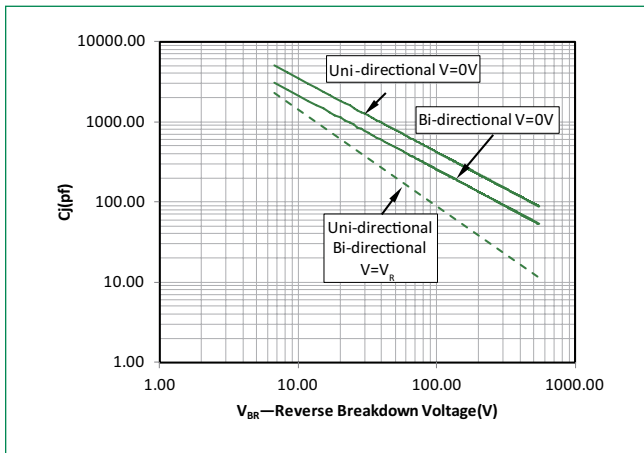

Figure 6 - Typical Transient Thermal Impedance

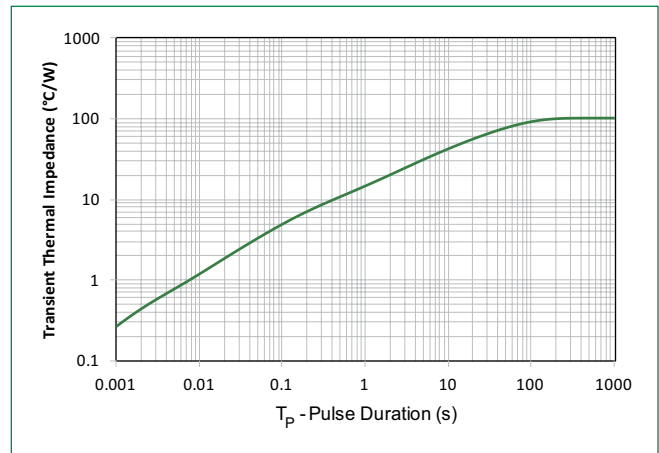

Figure 7 - Maximum Non-Repetitive Peak Forward Surge Current Uni-Directional Only

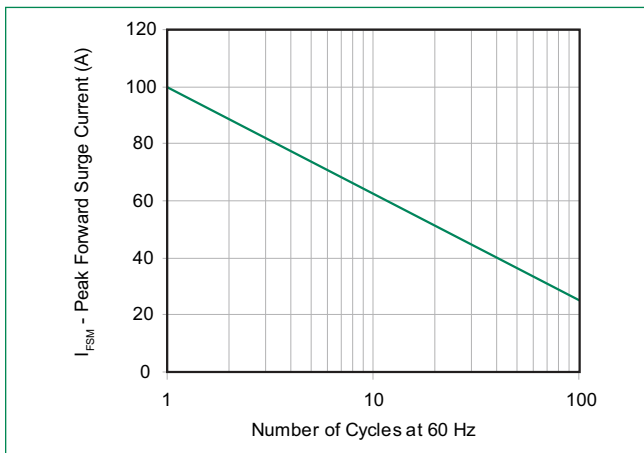
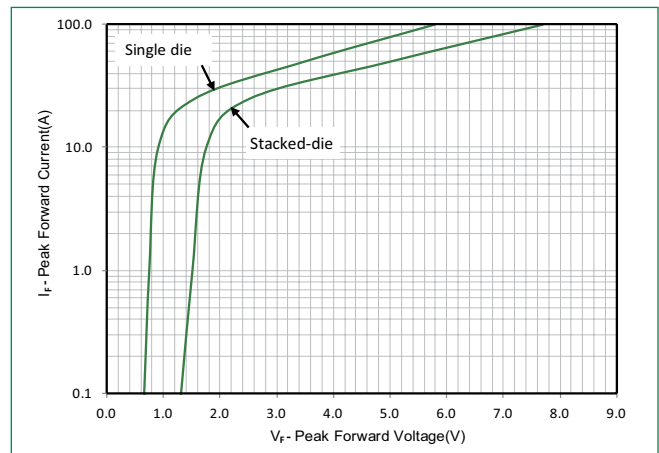
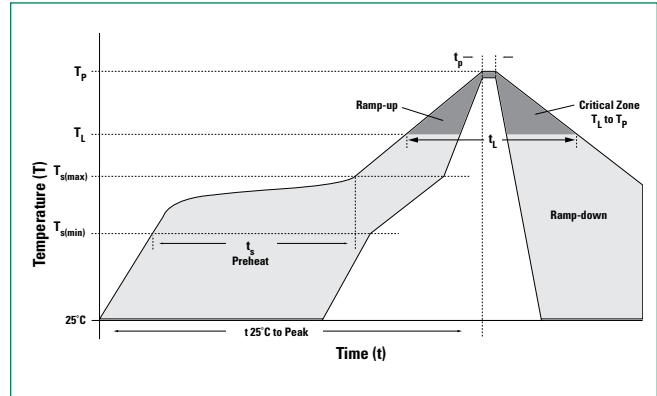

Figure 8 - Peak Forward Voltage Drop vs Peak Forward Current (Typical Values)



Soldering Parameters

| | | |
|--|------------------------------------|-------------------------|
| Reflow Condition | | Lead-free assembly |
| Pre Heat | - Temperature Min ($T_{s(min)}$) | 150°C |
| | - Temperature Max ($T_{s(max)}$) | 200°C |
| | - Time (min to max) (t_s) | 60 – 120 secs |
| Average ramp up rate (Liquidus Temp (T_L) to peak) | | 3°C/second max |
| $T_{s(max)}$ to T_L - Ramp-up Rate | | 3°C/second max |
| Reflow | - Temperature (T_L) (Liquidus) | 217°C |
| | - Time (min to max) (t_L) | 60 – 150 seconds |
| Peak Temperature (T_p) | | 260 ^{+0/-5} °C |
| Time within 5°C of actual peak Temperature (t_p) | | 30 seconds max |
| Ramp-down Rate | | 6°C/second max |
| Time 25°C to peak Temperature (T_p) | | 8 minutes Max. |
| Do not exceed | | 260°C |



Physical Specifications

| | |
|-----------------|---|
| Weight | 0.003 ounce, 0.093 grams |
| Case | JEDEC DO214AA. Molded plastic body over glass passivated junction |
| Polarity | Color band denotes cathode except Bidirectional |
| Terminal | Matte Tin-plated leads, Solderable per JESD22-B102 |

Environmental Specifications

| | |
|----------------------------|--------------------------|
| High Temp. Storage | JESD22-A103 |
| HTRB | JESD22-A108 |
| Temperature Cycling | JESD22-A104 |
| MSL | JEDEC-J-STD-020, Level 1 |
| H3TRB | JESD22-A101 |
| RSH | JESD22-A111 |

Dimensions

DO-214AA (SMB J-Bend)

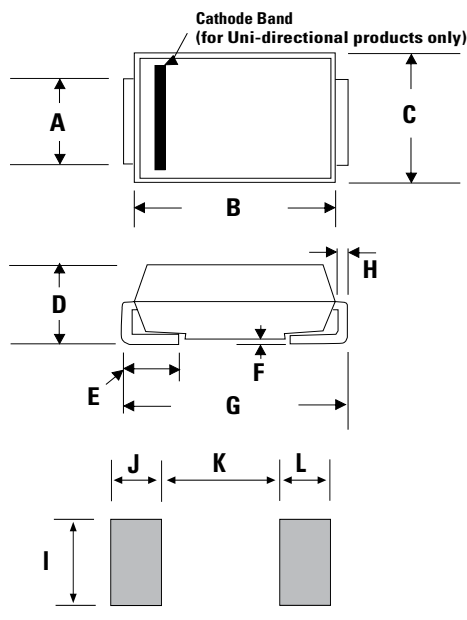

| Dimensions | Inches | | Millimeters | |
|------------|--------|-------|-------------|-------|
| | Min | Max | Min | Max |
| A | 0.076 | 0.086 | 1.930 | 2.200 |
| B | 0.160 | 0.187 | 4.060 | 4.750 |
| C | 0.130 | 0.155 | 3.300 | 3.940 |
| D | 0.078 | 0.103 | 1.990 | 2.610 |
| E | 0.030 | 0.060 | 0.760 | 1.520 |
| F | - | 0.008 | - | 0.203 |
| G | 0.205 | 0.220 | 5.210 | 5.590 |
| H | 0.006 | 0.012 | 0.152 | 0.305 |
| I | 0.089 | - | 2.260 | - |
| J | 0.085 | - | 2.160 | - |
| K | - | 0.107 | - | 2.740 |
| L | 0.085 | - | 2.160 | - |

Part Numbering System

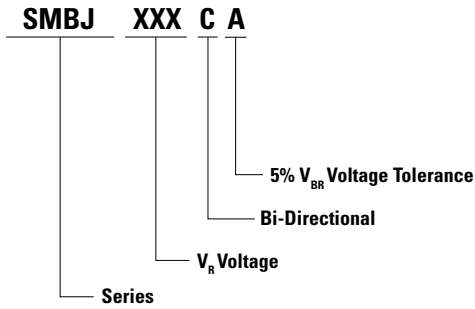

Part Marking System

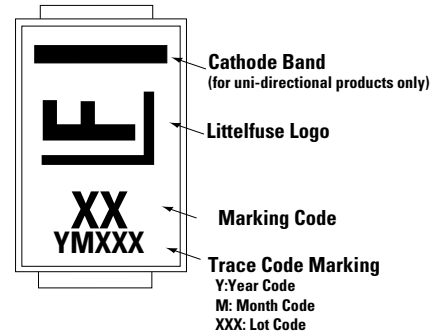

Packaging

| Part number | Component Package | Quantity | Packaging Option | Packaging Specification |
|-------------|-------------------|----------|----------------------------------|-------------------------|
| SMBJxxxXX | DO-214AA | 3000 | Tape & Reel - 12mm tape/13" reel | EIA STD RS-481 |

Tape and Reel Specification

