

JS Series Sub-Miniature Slide Switches

Features/Benefits

- Positive detent
- Low profile
- IR reflow to 260° solder profile
- Surface and thru hole mounting
- SPDT, DPDT, DP3T models
- RoHS compliant

Typical Applications

- Telecommunication products
- Computer peripherals
- Thermostat select switch
- Instrumentation
- Medical

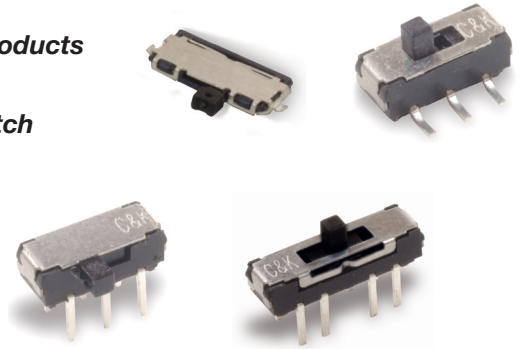

Specifications

CONTACT RATING: 6 VDC @ 0.3A
 ELECTRICAL LIFE: 5,000 make-and-break cycles
 CONTACT RESISTANCE: 70 m Ω max.
 INSULATION RESISTANCE: 100 M Ω min. @ 500V.
 DIELECTRIC STRENGTH: 500 VAC min. @ sea level.
 OPERATING TEMPERATURE: -40°C to +85°C
 STORAGE TEMPERATURE: -40°C to +85°C

NOTE: Specifications and materials listed above are for switches with standard options.
 For information on specific and custom switches, consult Customer Service Center.

Materials

HOUSING: 4/6 nylon (UL94V-2), black.
 ACTUATOR: 4/6 nylon (UL94V-2), black (some options white).
 CONTACTS: Copper alloy, silver plated.
 TERMINALS: Brass, silver plated

RIGHT ANGLE, PC THRU-HOLE

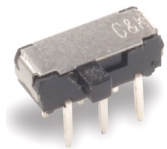
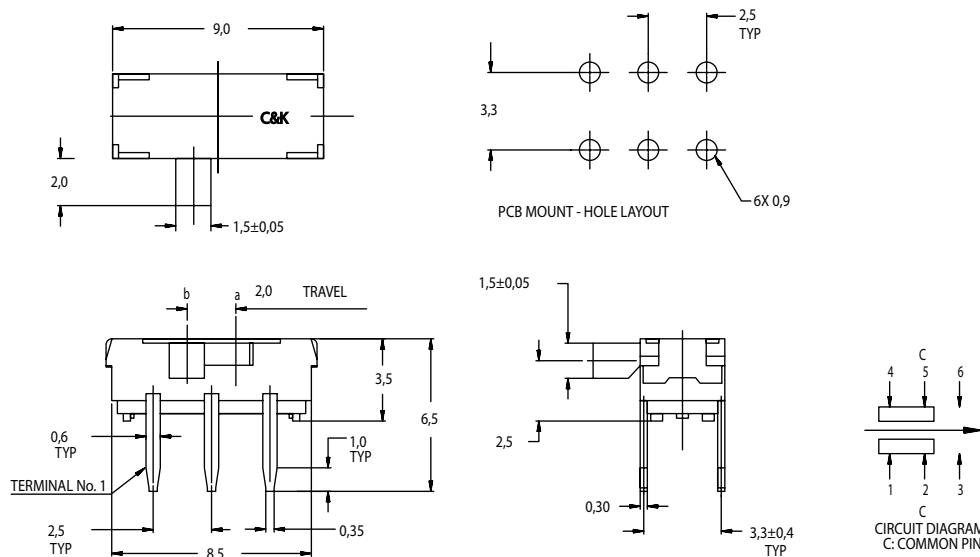

Part Number
 JS202011AQN
DPDT

Shown in position b

Shown in position b

JS Series Sub-Miniature Slide Switches

RIGHT ANGLE, PC THRU-HOLE

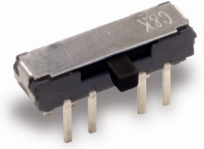
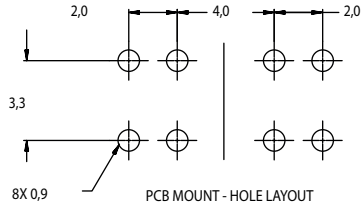
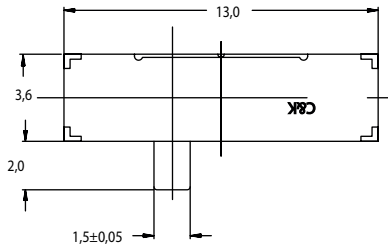

Part Number
JS203011AQN
DP3T

Shown in position b

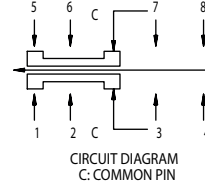
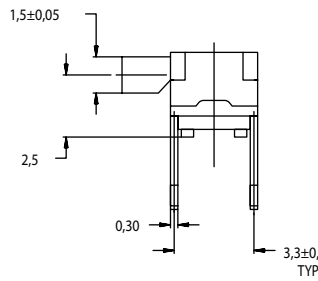
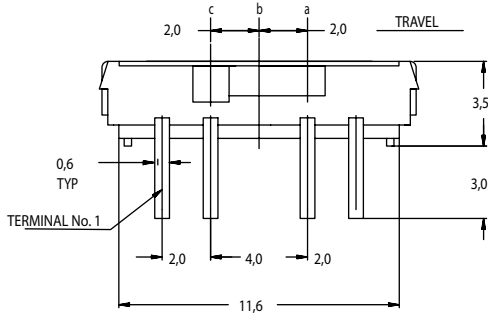

CIRCUIT DIAGRAM
C: COMMON PIN

Shown in position c

PC THRU-HOLE

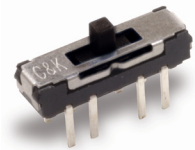
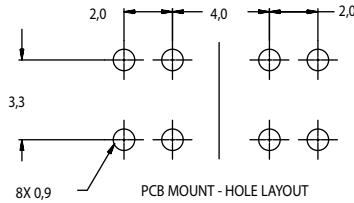
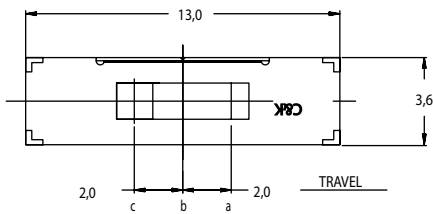

Part Number
JS203011CQN
DP3T

Shown in position b

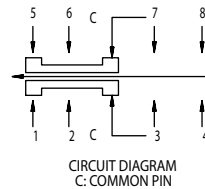
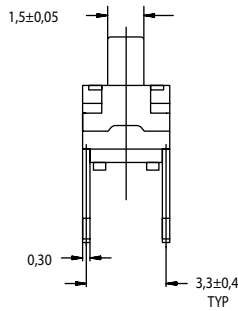
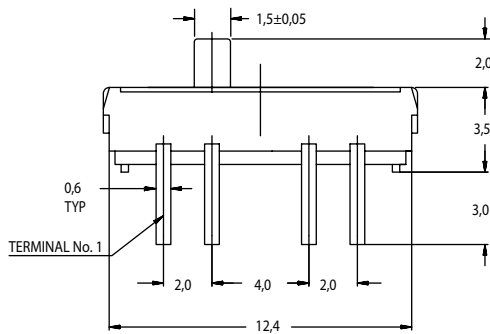

CIRCUIT DIAGRAM
C: COMMON PIN

Shown in position c



11 Nov 19

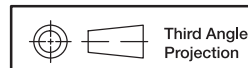

Third Angle
Projection

Dimensions are shown: mm
Specifications and dimensions subject to change

Slide

JS Series Sub-Miniature Slide Switches

PC THRU-HOLE

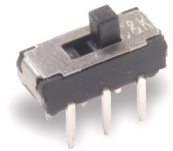
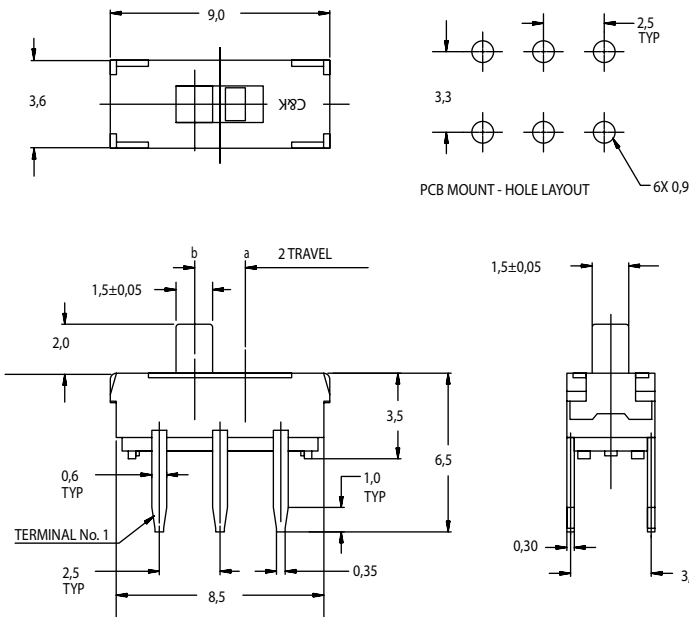

Part Number
JS202011CQN
DPDT

Shown in position a

Shown in position b



Slide

SURFACE MOUNT

Part number
JS202011SCQN
DPDT

Shown in position b. Quantity per reel 1000
Available in tape & reel only, see page I-58

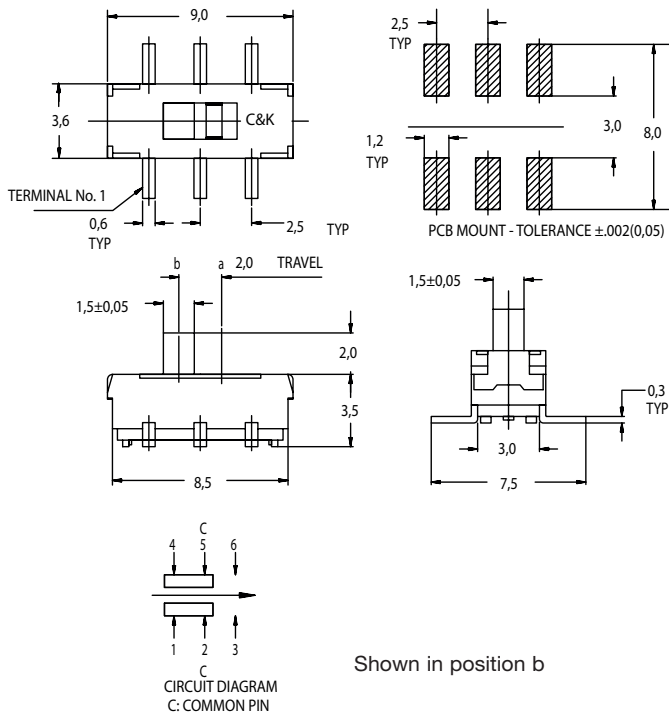

Shown in position b

Part number
JS203011SCQN
DP3T

Quantity per reel 900
Available in tape & reel only, see page I-60

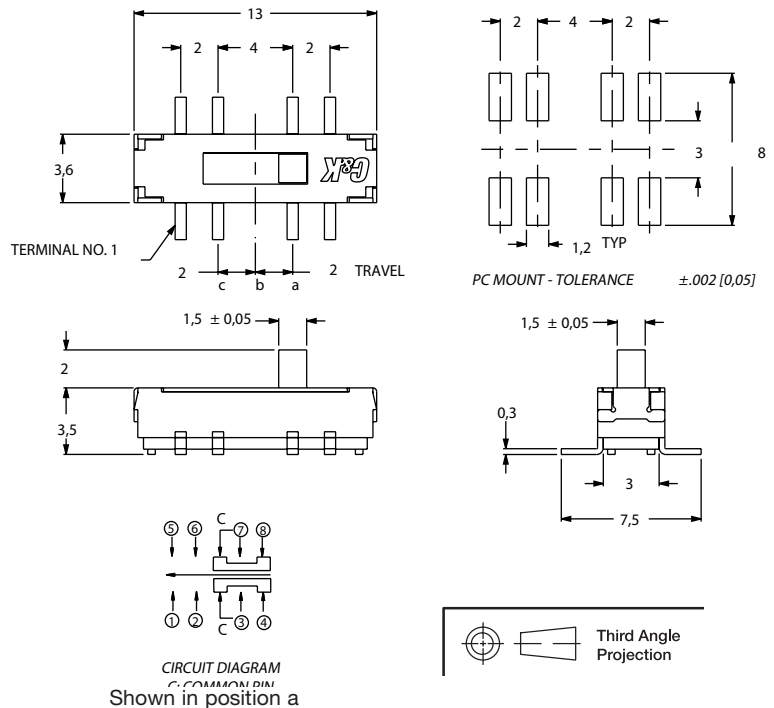

Shown in position a



Third Angle
Projection

JS Series Sub-Miniature Slide Switches

RIGHT ANGLE SURFACE MOUNT

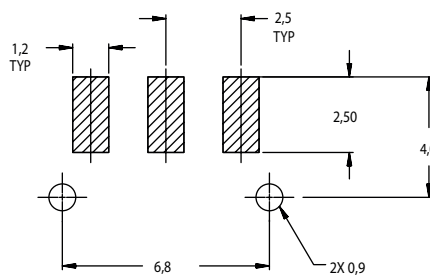
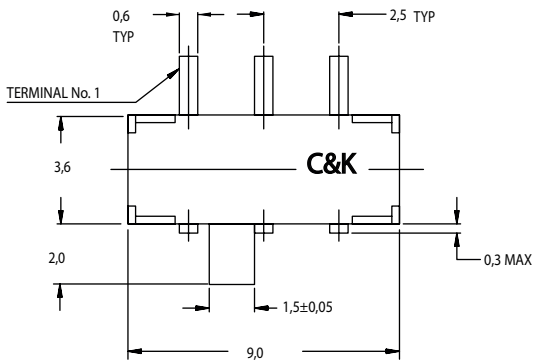

Part Number
JS102011SAQN
SPDT

Shown in position a

Available in tape & reel only, see page I-59

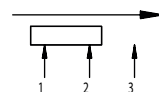
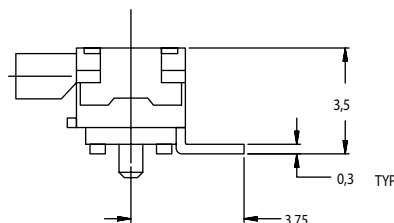
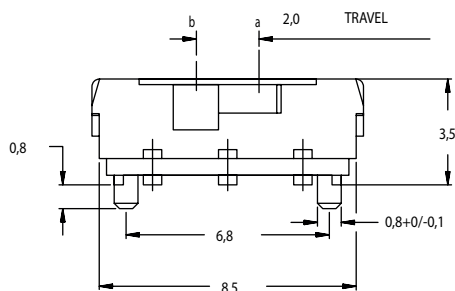

CIRCUIT DIAGRAM
C: COMMON PIN

Shown in position b

Slide

PC THRU-HOLE

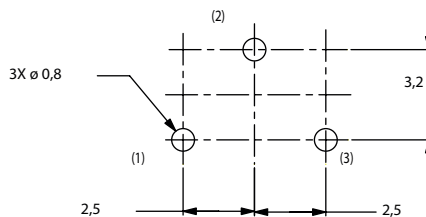
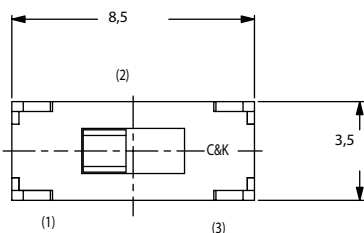

PCB LAYOUT RECOMMENDED



Part Number
JS102011CQN
SPDT

Shown in position a

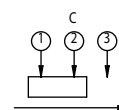
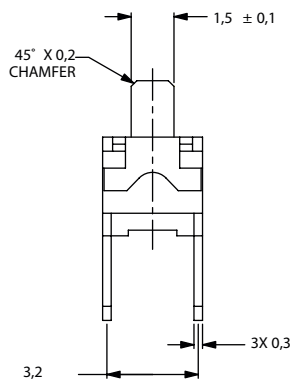
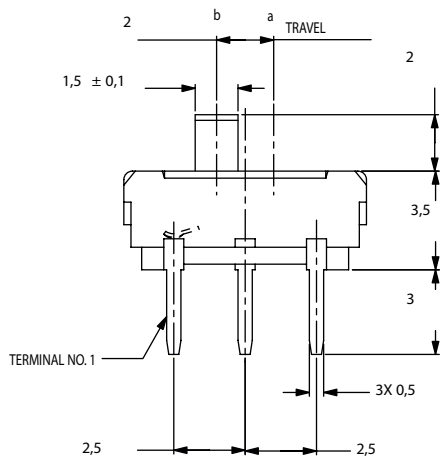

SCHMATIC

Shown in position b

JS Series Sub-Miniature Slide Switches

SURFACE MOUNT

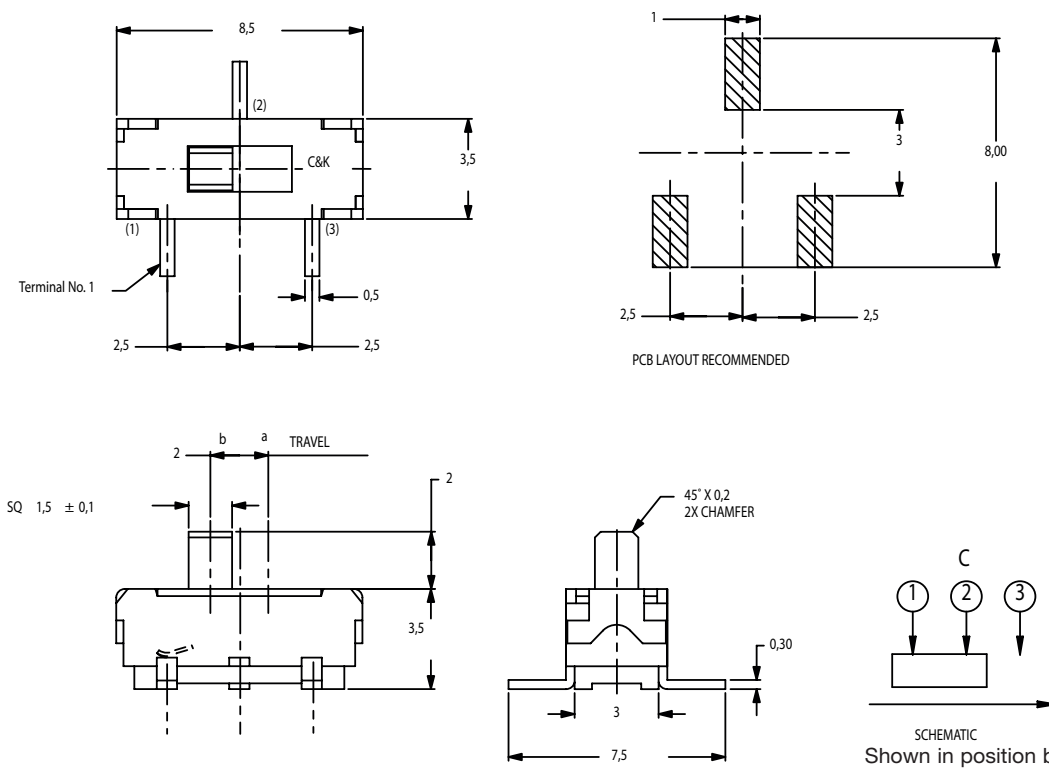

Slide

SURFACE MOUNT

NEW

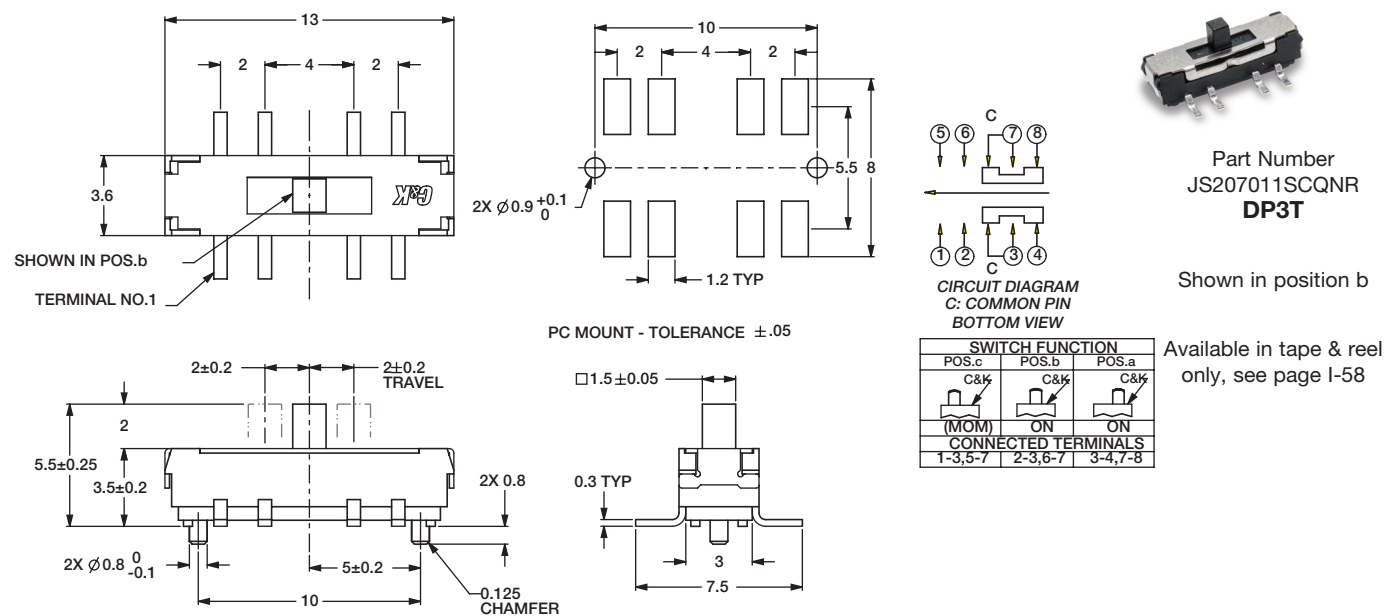

Dimensions are shown: mm
Specifications and dimensions subject to change

JS Series Sub-Miniature Slide Switches

PC THRU-HOLE

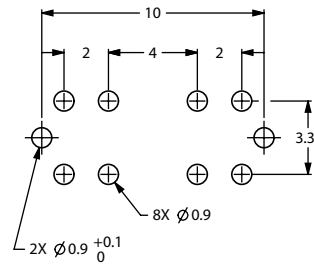
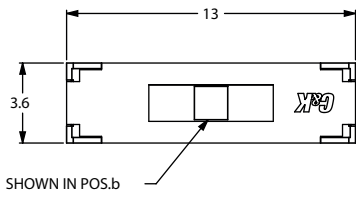

PC MOUNT - TOLERANCE ±.05

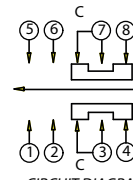

CIRCUIT DIAGRAM
C: COMMON PIN
BOTTOM VIEW

SWITCH FUNCTION		
POS.c	POS.b	POS.a
(MOM)	ON	ON
CONNECTED TERMINALS		
1-3,5-7	2-3,6-7	3-4,7-8

NEW

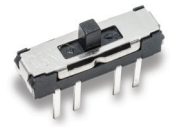

Part Number
JS207011CQNR
DP3T

Shown in position b

Slide

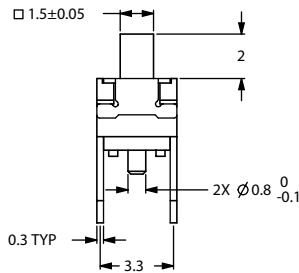
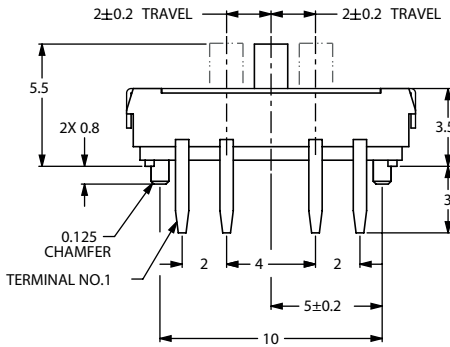

RIGHT ANGLE SURFACE MOUNT

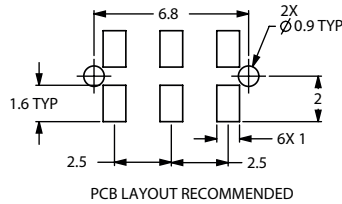
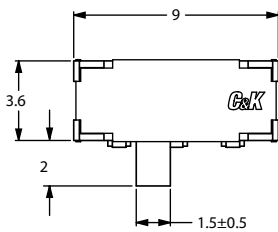

PCB LAYOUT RECOMMENDED

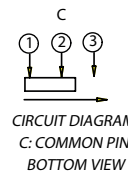

CIRCUIT DIAGRAM
C: COMMON PIN
BOTTOM VIEW

NEW



Part Number
JS102011JAQN
SPDT

Shown in position

Available in tape & reel
only, see page I-59

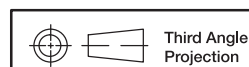
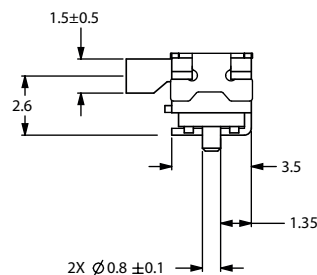
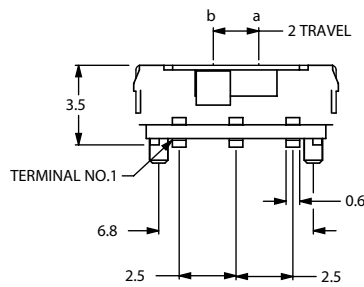

Third Angle
Projection

Dimensions are shown: mm
Specifications and dimensions subject to change



11 Nov 19

JS Series Sub-Miniature Slide Switches

VERTICAL MOUNT SMT - J BEND

NEW



Part Number
JS102011JCQN
SPDT

Available in tape & reel
only, see page I-59

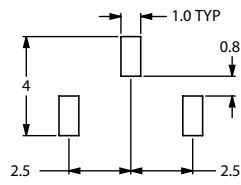
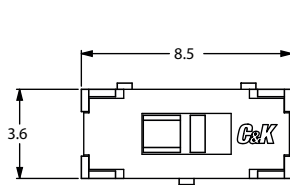

PCB LAYOUT RECOMMENDED



CIRCUIT DIAGRAM
C: COMMON PIN
BOTTOM VIEW

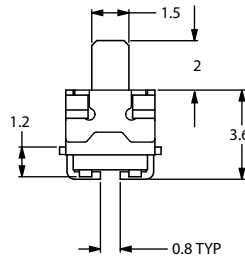
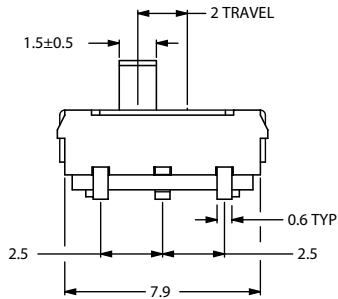

RIGHT ANGLE SURFACE MOUNT

NEW



Part Number
JS202011JAQN
DPDT

Shown in position

Available in tape & reel
only, see page I-61

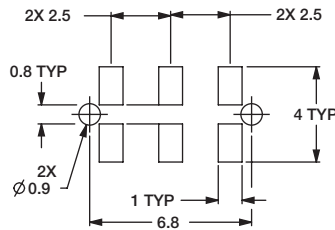
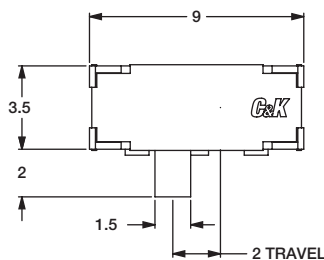

PCB LAYOUT RECOMMENDED

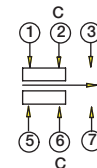

CIRCUIT DIAGRAM
C: COMMON PIN
BOTTOM VIEW

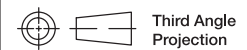
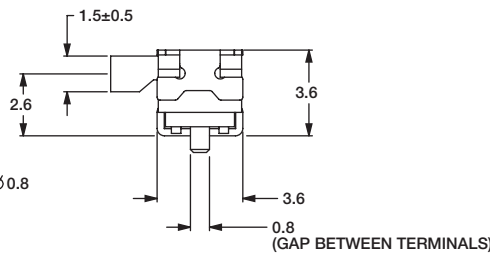
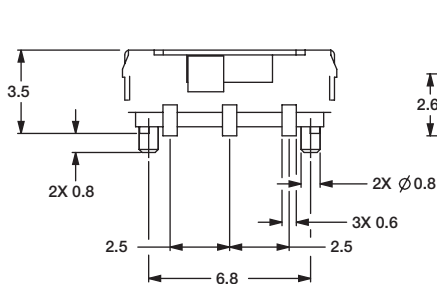

Third Angle
Projection

Dimensions are shown: mm
Specifications and dimensions subject to change

JS Series Sub-Miniature Slide Switches

VERTICAL MOUNT SMT - J BEND

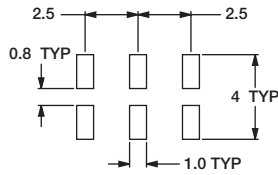
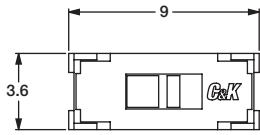

PCB LAYOUT RECOMMENDED

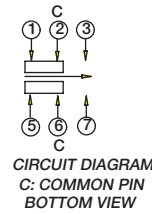

Part Number
JS202011JCQN
DPDT

Shown in position

Available in tape & reel
only, see page I-61

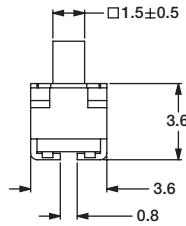
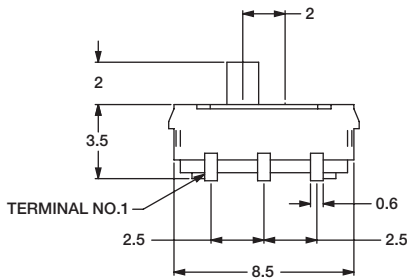

RIGHT ANGLE MOUNT SMT - J BEND

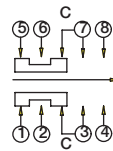
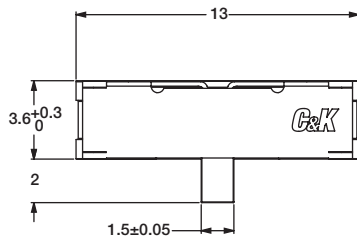

Part Number
JS203011JAQN
DP3T

Shown in position

Available in tape & reel
only, see page I-60

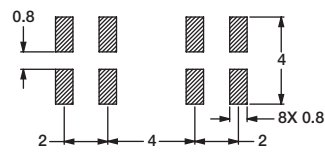
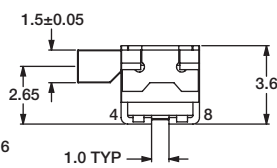
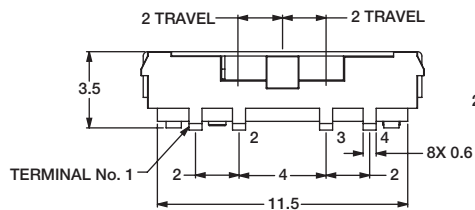

JS Series Sub-Miniature Slide Switches

NEW

VERTICAL MOUNT SMT - J BEND

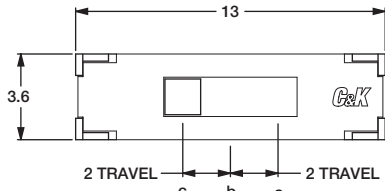

Shown in position c

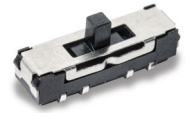
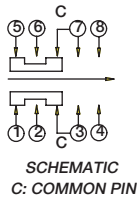

Part Number
JS203011JCQN
DP3T

Shown in position b
Available in tape & reel
only, see page I-60

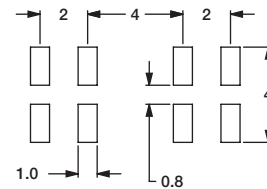
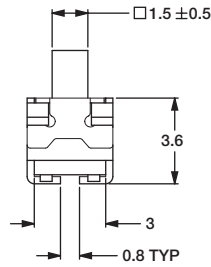
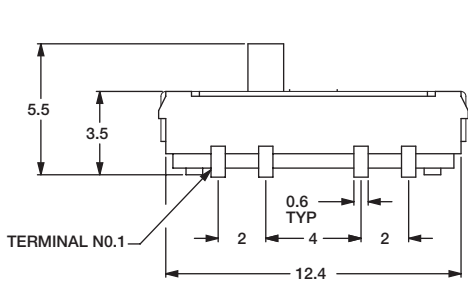

PCB LAYOUT RECOMMENDED

Slide

SURFACE MOUNT - J BEND

NEW

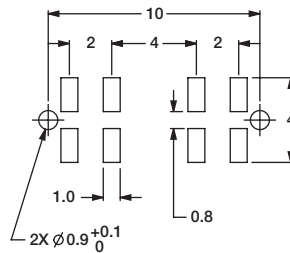
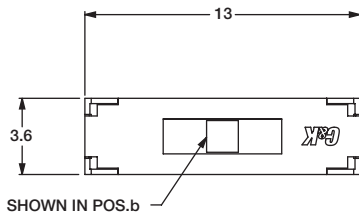

PC MOUNT - TOLERANCE ±.05

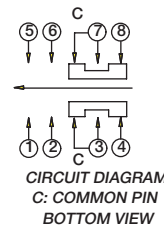

Part Number
JS207011JCQNR
DP3T

Available in tape & reel
only, see page I-58

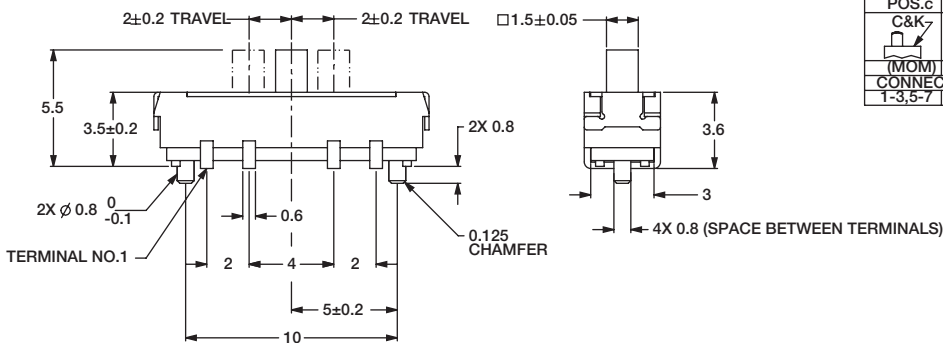

SWITCH FUNCTION		
POS.c	POS.b	POS.a
C&K- (MOM)	C&K- ON	C&K- ON
CONNECTED TERMINALS		
1-3,5-7	2-3,6-7	3-4,7-8

JS Series Sub-Miniature Slide Switches

TAPE AND REEL FOR PART NUMBER JS207011SCQNR, JS207011JCQNR

Quantity per reel 800

PACKING DETAIL 800 PCS

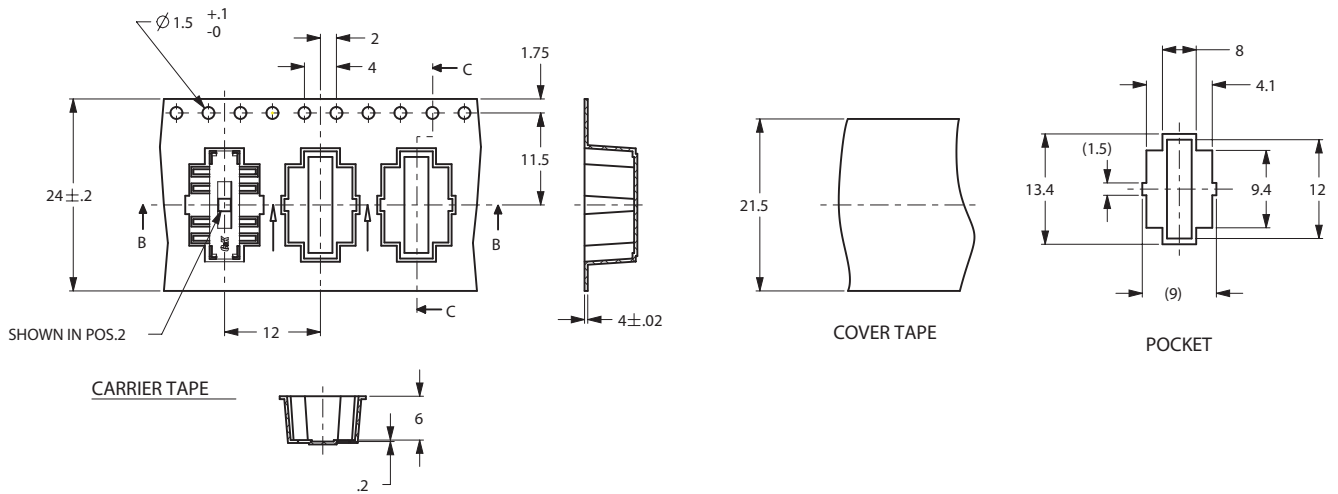
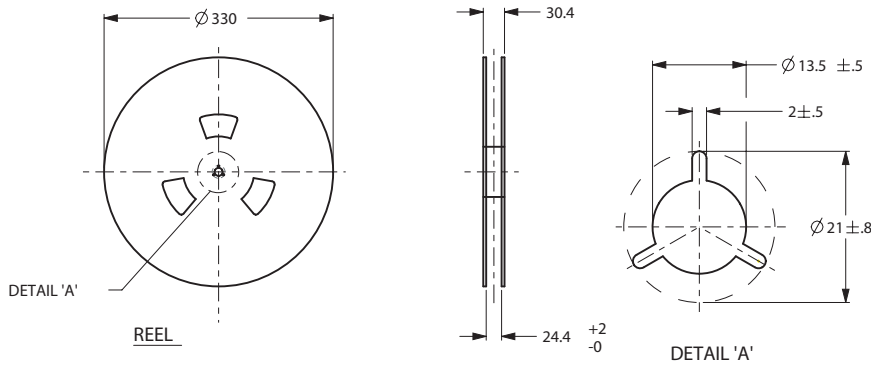

TAPE AND REEL FOR PART NUMBER JS202011SCQN

Quantity per reel 1000

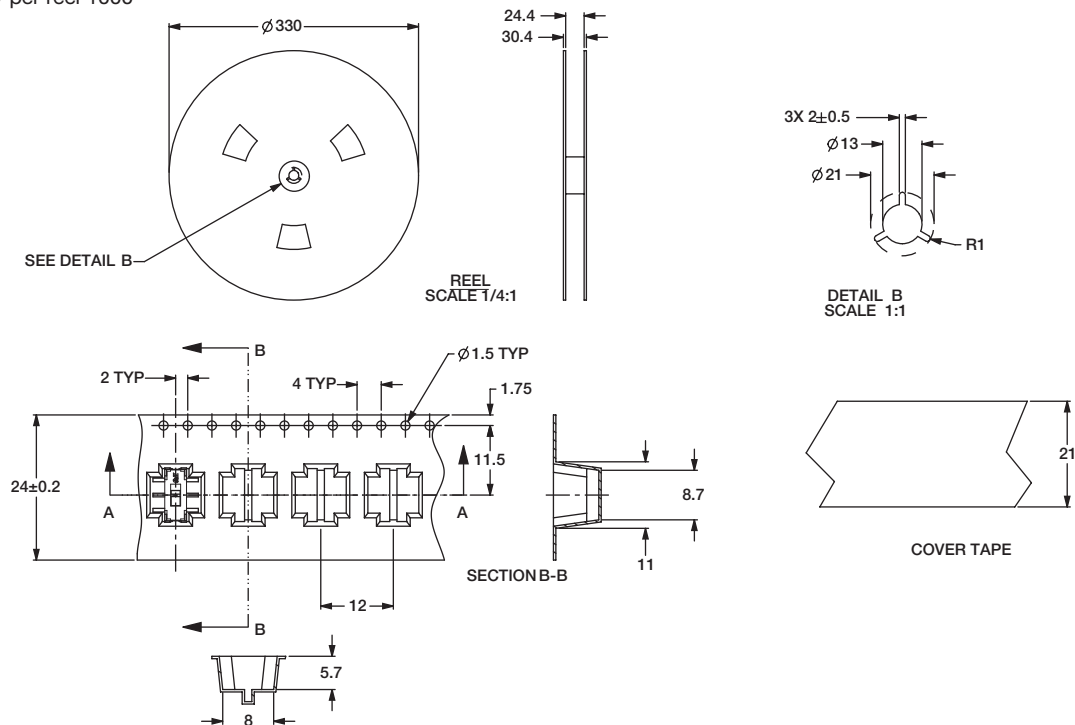

Slide

JS Series Sub-Miniature Slide Switches

TAPE AND REEL FOR PART NUMBER JS102011SCQN, JS102011JCQN

Quantity per reel 1000

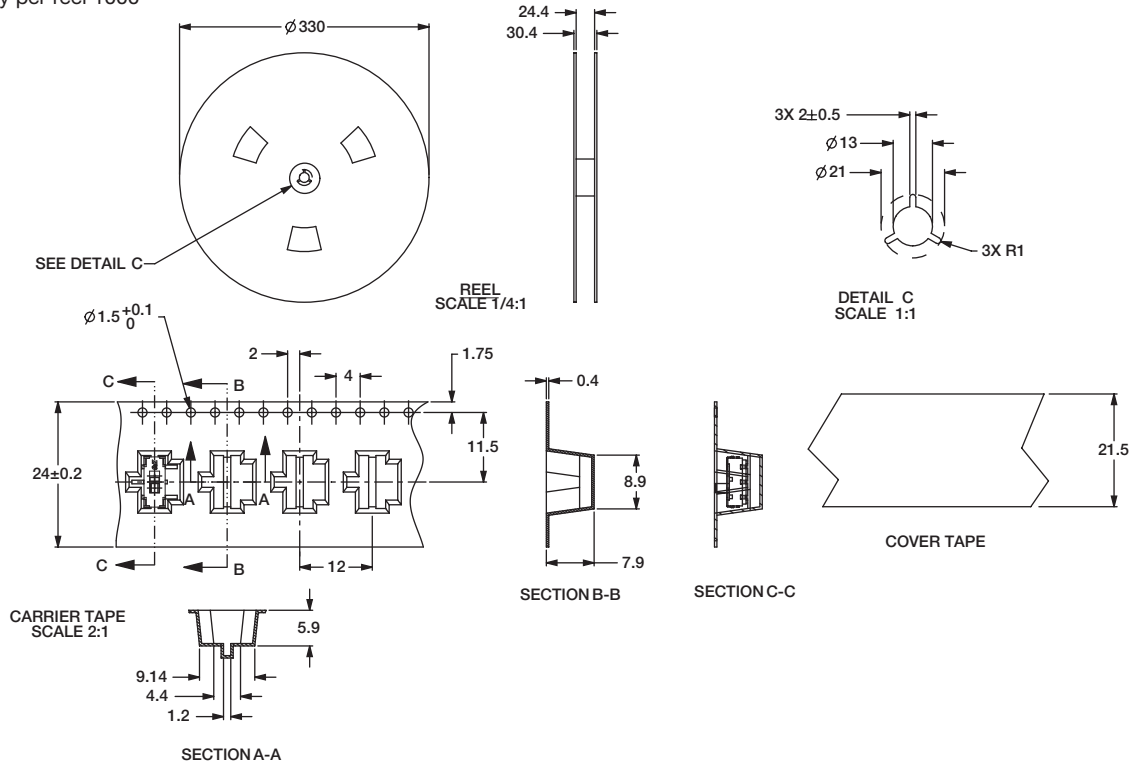

TAPE AND REEL FOR PART NUMBER JS102011SAQN, JS102011JAQN

Quantity per reel 1000

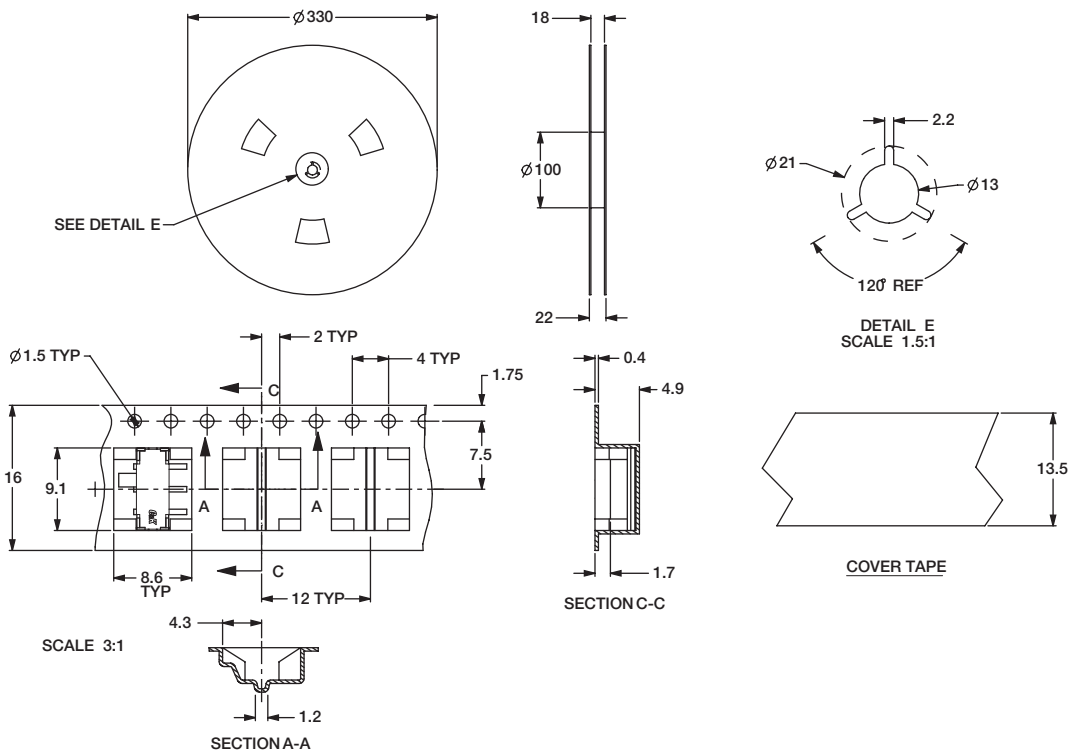

Dimensions are shown: mm
Specifications and dimensions subject to change

JS Series Sub-Miniature Slide Switches

RIGHT ANGLE SURFACE MOUNT

LOW PROFILE .028±.004 (0.7±0.1) HIGH



Part Number
JS102000SAQN
SPDT

Specifications

CONTACT RATING: 5 VDC @ 1mA

ELECTRICAL LIFE: 15,000 cycles.

CONTACT RESISTANCE: <100 m ohms (initial) <200 m ohms (after processing).

INSULATION RESISTANCE: 100 m ohms @500 VDC.

DIELECTRIC STRENGTH: 250 VAC.

OPERATING TEMPERATURE: -40°C to +85°C

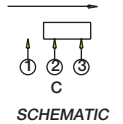
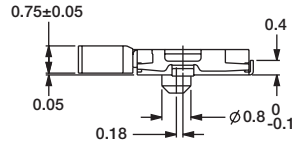
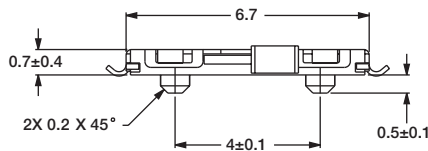
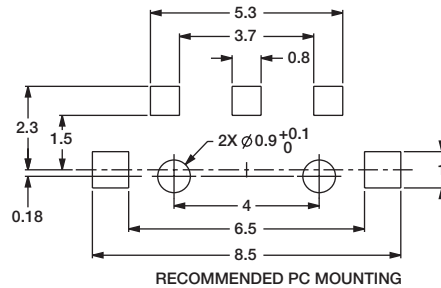
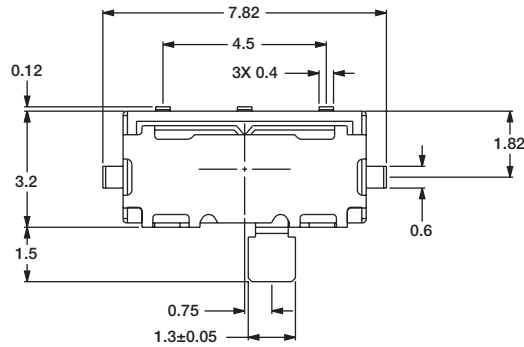

TAPE AND REEL FOR PART NUMBER JS102000SAQN

Quantity per reel 4000

