

Features

- Fast switching
- Green Device Available
- Suit for 1.5V Gate Drive Applications

Application

- Notebook
- Load Switch
- Networking
- Hand-held Instruments

Package and Pin Configuration

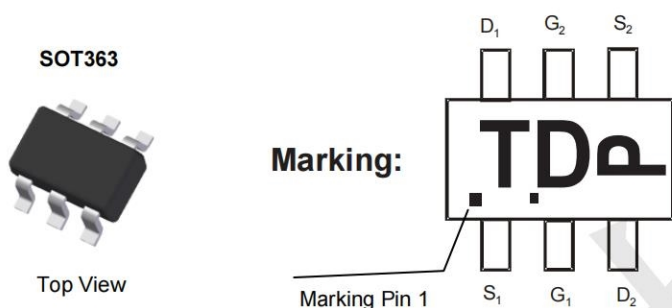

Circuit diagram

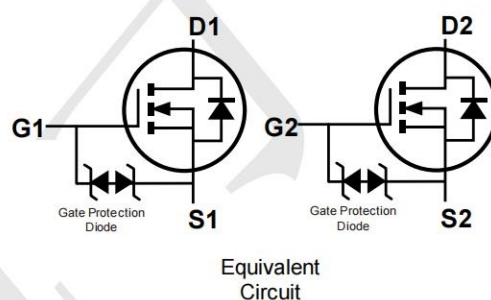

Package orientation in reel

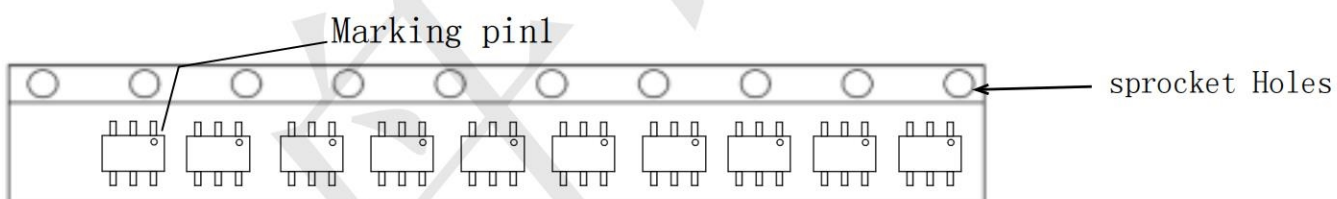

Shipping: 3000pcs / Tape & Reel

Absolute Maximum Ratings (T_A=25°C unless otherwise noted)

Parameter	Symbol	Value	Unit
Drain-Source Voltage	V _{DS}	20	V
Gate-Source Voltage	V _{GS}	±10	V
Continuous Drain Current	I _D	0.7	A
Pulsed Drain Current (t=300μs) ⁽¹⁾	I _{DM}	1.8	A
Power Dissipation ⁽²⁾	P _D	100	mW
Thermal Resistance from Junction to Ambient	R _{θJA}	833	°C/W
Junction Temperature	T _J	150	°C
Storage Temperature	T _{STG}	-55~ +150	°C

Electrical Characteristics ($T_A = 25^\circ\text{C}$ unless otherwise noted)

Parameter	Symbol	Test Condition	Min	Type	Max	Unit
Static Characteristics						
Drain-source breakdown voltage	$V_{(BR)DSS}$	$V_{GS} = 0V, I_D = 250\mu A$	20			V
Zero gate voltage drain current	I_{DSS}	$V_{DS} = 20V, V_{GS} = 0V$			1	μA
Gate-body leakage current	I_{GSS}	$V_{GS} = \pm 10V, V_{DS} = 0V$			± 10	μA
Gate threshold voltage ⁽³⁾	$V_{GS(th)}$	$V_{DS} = V_{GS}, I_D = 250\mu A$	0.5	0.75	1.5	V
Drain-source on-resistance ⁽³⁾	$R_{DS(on)}$	$V_{GS} = 4.5V, I_D = 650mA$		130	330	m Ω
		$V_{GS} = 2.5V, I_D = 550mA$			410	
Forward tranconductance	g_{FS}	$V_{DS} = 10V, I_D = 500mA$			1.2	S
Dynamic characteristics⁽⁴⁾						
Input Capacitance	C_{iss}	$V_{DS} = 16V, V_{GS} = 0V, f = 1MHz$			120	pF
Output Capacitance	C_{oss}				20	
Reverse Transfer Capacitance	C_{rss}				15	
Switching Characteristics⁽⁴⁾						
Turn-on delay time	$t_{d(on)}$	$V_{DD} = 10V, I_D = 500mA,$ $V_{GS} = 4.5V, R_G = 10\Omega$		6.7		ns
Turn-on rise time	t_r			4.8		
Turn-off delay time	$t_{d(off)}$			17.3		
Turn-off fall time	t_f			7.4		
Source-Drain Diode characteristics						
Diode Forward voltage ⁽³⁾	V_{DS}	$I_S = 0.15A, V_{GS} = 0V$			1.2	V

Outline Drawing - SOT-363(2.0X2.1)

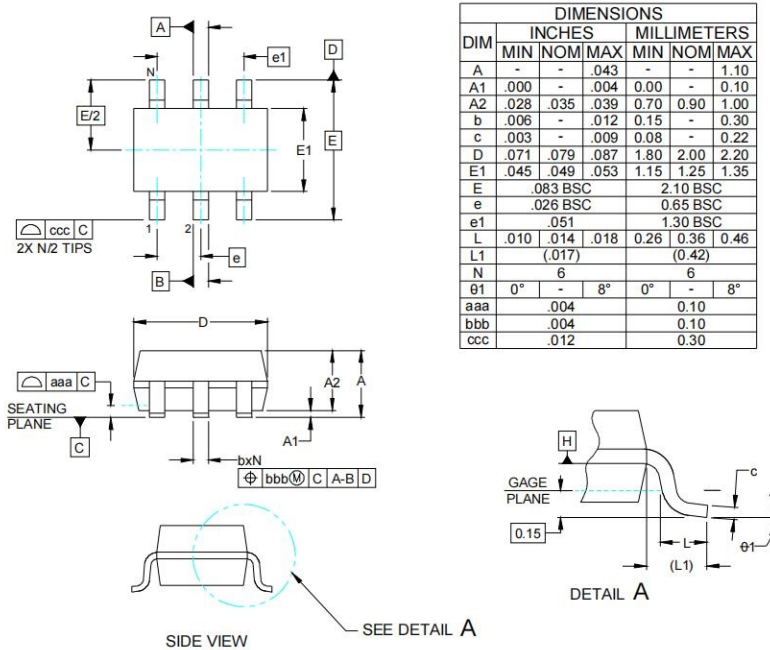

Land Pattern - SOT-363

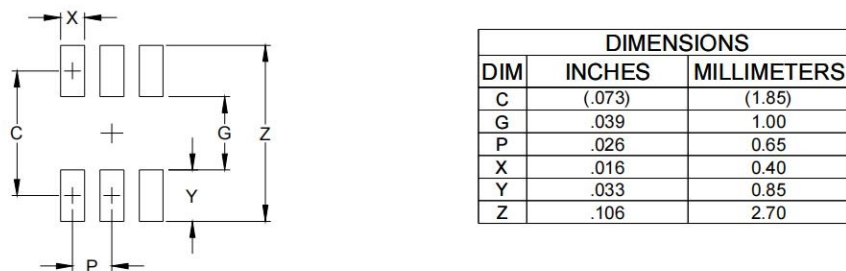

SOT-363 Embossed Carrier Tape

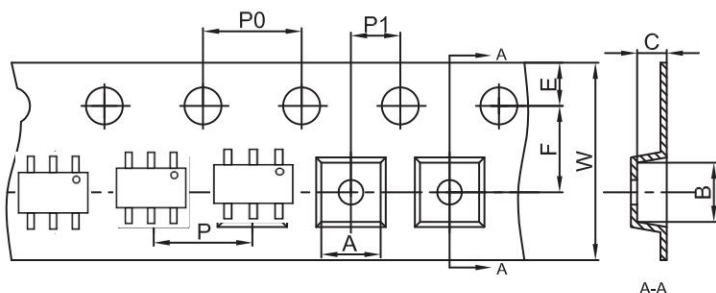

Dimensions are in millimeter											
Pkg type	A	B	C	d	E	F	P0	P	P1	W	
SOT-363	2.25	2.55	1.20	Ø1.50	1.75	3.50	4.00	4.00	2.00	8.00	

SOT-363 Tape Leader and Trailer

Package orientation in reel

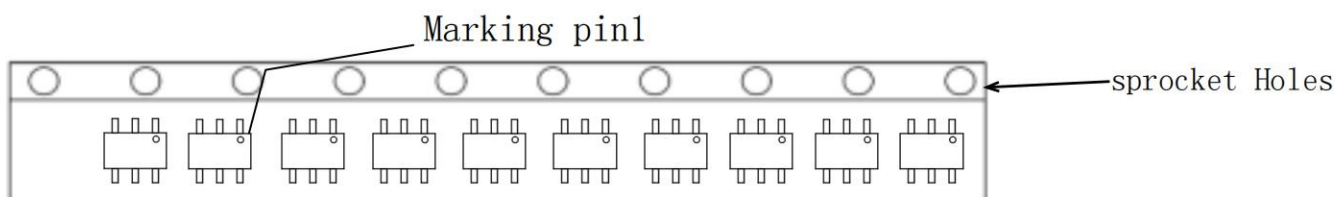

Shipping: 3000 pcs / Tape & Reel

SOT-363 Reel

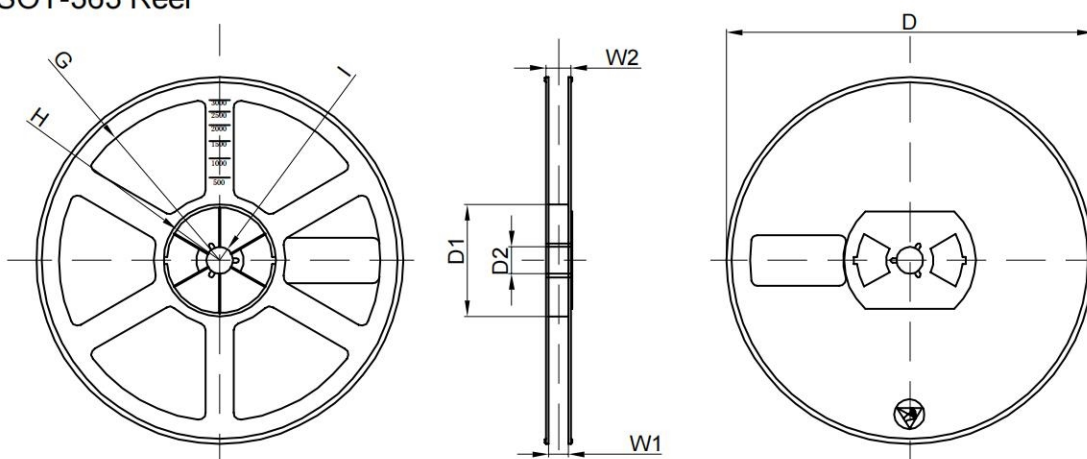

Dimensions are in millimeter								
Reel Option	D	D1	D2	G	H	I	W1	W2
7" Dia	Ø178.00	54.40	13.00	R78.00	R25.60	R6.50	9.50	12.30

REEL	Reel Size	Box	Box Size(mm)	Carton	Carton Size(mm)	G.W.(kg)
3000 pcs	7 inch	45,000 pcs	203×203×195	180,000 pcs	438×438×220	