

### Description

The LM2575/6 series switching regulators are monolithic integrated circuits designed for use in “buck” or “buck/boost” regulator applications requiring accurate output voltages over combined variations of line, load and temperature. This unique series greatly simplifies switching power supply design. The LM2575 has a maximum output current of 1A and the LM2576 is rated for 3A.

The LM2575/6 series miniconverters include a switching regulator and compensation network all within the same package. Just add a choke, catch diode and two capacitors to obtain an efficient DC-to-DC converter. The current limit and thermal shutdown features of the LM2575/6 series fully protect the device against overstress conditions.

The LM2575/6 series offers an alternative to popular 3 terminal linear regulators by providing higher efficiency with reduced heatsink size. In many applications a heat sink will not be required.

### Features

- ◆ Pin for pin replacement for National’s LM2575/6 series
- ◆ DC-to-DC buck or buck/boost converter requiring only 4 support components
- ◆ Fixed or adjustable voltages
- ◆ Preset output voltages of 3.3V, 5V and 12V
- ◆ Wide output voltage range, 1.23V to 35V
- ◆ 82% typical efficiency @ 5V out
- ◆ Wide input voltage range, 4V to 40V
- ◆ Inhibit/enable control pin
- ◆ Industrial temperature range
- ◆ TO-220 and TO-263 packages

### Applications

- ◆ Micro controller power supplies
- ◆ Medical equipment
- ◆ Industrial power supplies
- ◆ Instrumentation power supplies

### Typical Application Circuits

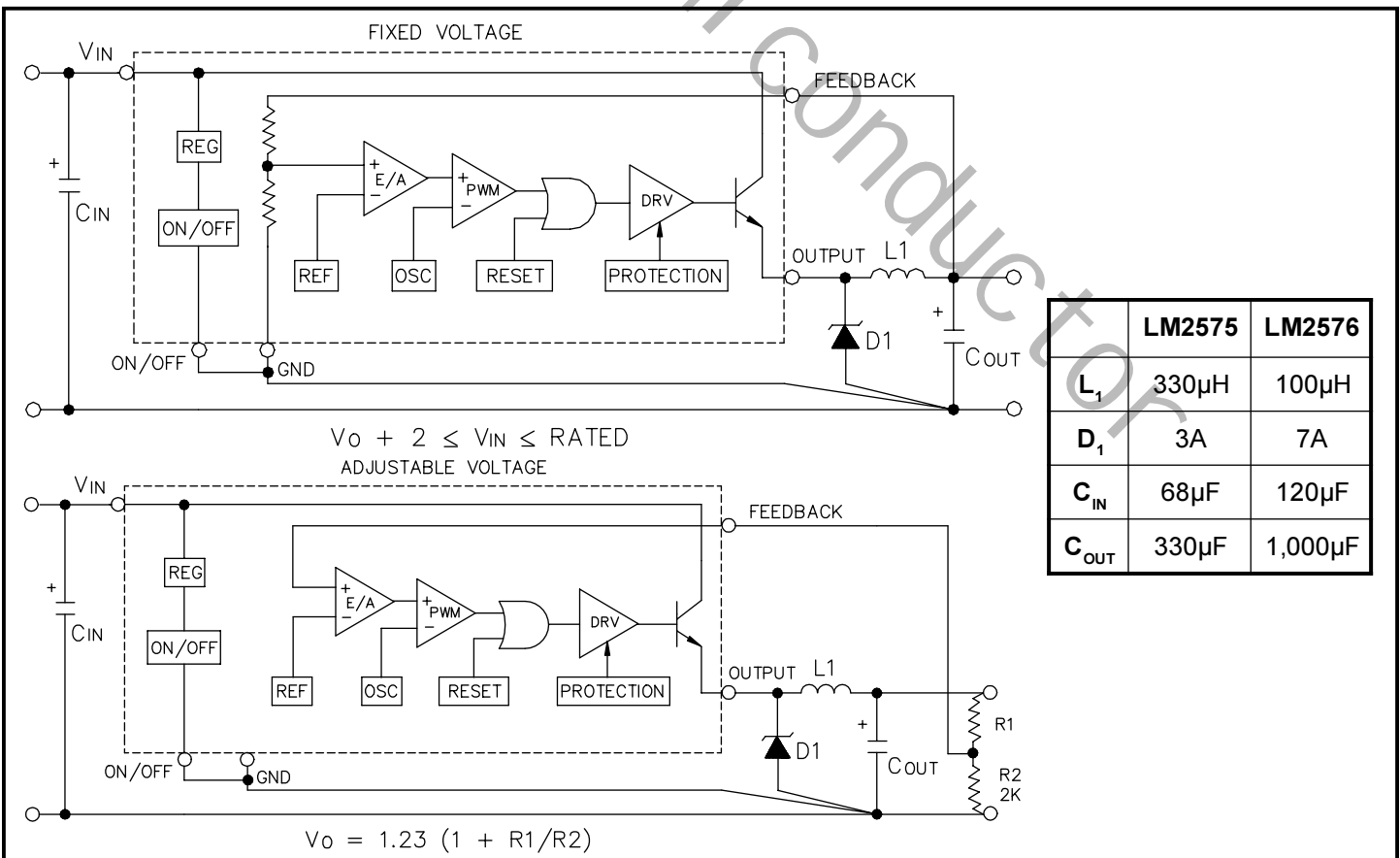

### Absolute Maximum Ratings

Parameter	Symbol	Maximum	Units
Input Voltage	$V_{IN}$	45	V
On/Off Pin Input Voltage	$V_{ON/OFF}$	$-0.3 \leq V_{ON/OFF} \leq V_{IN}$	V
Output Voltage to Common (Steady State)		-1	V
Power Dissipation	$P_D$	Internally Limited	W
Thermal Resistance Junction to Ambient TO-220 TO-263	$\theta_{JA}$	55 60	$^{\circ}\text{C/W}$
Thermal Resistance Junction to Case TO-220 TO-263	$\theta_{JC}$	2.0 2.0	$^{\circ}\text{C/W}$
Operating Junction Temperature Range	$T_J$	-40 to +125	$^{\circ}\text{C}$
Storage Temperature Range	$T_{STG}$	-65 to +150	$^{\circ}\text{C}$
Lead Temperature (Soldering) 10 Sec.	$T_{LEAD}$	300	$^{\circ}\text{C}$
ESD Rating (Human Body Model)	$V_{ESD}$	2	kV

### Electrical Characteristics

Unless otherwise specified:  $V_{IN} = 12\text{V}$  for 3.3V, 5V and ADJ options and 25V for 12V option;  $V_{OUT} = 5\text{V}$  for ADJ option;  $T_A = 25^{\circ}\text{C}$ ;  $V_{IN}$  rated = 40V;  $I_O = 0.5$  to 3A (LM2576), 0.2 to 1A (LM2575). Values in **bold** apply over full operating temperature range.

Parameter	Symbol	Test Conditions	Min	Typ	Max	Units
Output Voltage LM2576S-3.3	$V_O$	$I_O = 0.5\text{A}$	3.23	3.30	3.37	V
		8V to $V_{IN}$ Rated	3.20		3.40	
			<b>3.14</b>		<b>3.47</b>	
Output Voltage LM2576S-5.0	$V_O$	$I_O = 0.5\text{A}$	4.90	5.00	5.10	V
		8V to $V_{IN}$ Rated	4.85		5.15	
			<b>4.75</b>		<b>5.25</b>	
Output Voltage LM2576-12	$V_O$	$I_O = 0.5\text{A}$	11.76	12.00	12.24	V
		15V to $V_{IN}$ Rated	11.52		12.48	
			<b>11.40</b>		<b>12.60</b>	
Feedback Voltage LM2576S-ADJ, $V_O = 5\text{V}$	$V_{FB}$	$I_O = 0.5\text{A}$	1.217	1.230	1.243	V
		8V to $V_{IN}$ Rated	1.193		1.267	
			<b>1.180</b>		<b>1.280</b>	
Feedback Bias Current LM2576S-ADJ	$I_B$	$V_{IN} = 12\text{V}, I_O = 0.5\text{A}$		50	100	nA
					<b>500</b>	

**Electrical Characteristics (Cont.)**

Unless otherwise specified:  $V_{IN} = 12V$  for 3.3V, 5V and ADJ options and 25V for 12V option;  $V_{OUT} = 5V$  for ADJ option;  $T_A = 25^\circ C$ ;  $V_{IN}$  rated = 40V;  $I_o = 0.5$  to 3A (LM2576), 0.2 to 1A (LM2575). Values in **bold** apply over full operating temperature range.

Parameter	Symbol	Test Conditions	Min	Typ	Max	Units
Output Voltage LM2575S-3.3	$V_o$	$I_o = 0.2A$	3.23	3.30	3.37	V
		8V to $V_{IN}$ Rated	3.20		3.40	
			<b>3.14</b>		<b>3.47</b>	
Output Voltage LM2575S-5.0	$V_o$	$I_o = 0.2A$	4.90	5.00	5.10	V
		8V to $V_{IN}$ Rated	4.85		5.15	
			<b>4.75</b>		<b>5.25</b>	
Output Voltage LM2575-12	$V_o$	$I_o = 0.2A$	11.76	12.00	12.24	V
		15V to $V_{IN}$ Rated	11.52		12.48	
			<b>11.40</b>		<b>12.60</b>	
Feedback Voltage LM2575S-ADJ, $V_o = 5V$	$V_{FB}$	$I_o = 0.2A$	1.217	1.230	1.243	V
		8V to $V_{IN}$ Rated	1.193		1.267	
			<b>1.180</b>		<b>1.280</b>	
Feedback Bias Current LM2575S-ADJ	$I_b$	$V_{IN} = 12V, I_o = 0.2A$		50	100	nA
					<b>500</b>	
Efficiency/Option 3.3V	$\eta$	$V_{IN} = 12V, I_o = 1A$ (LM2575, 3A for LM2576)		77		%
5V				82		
12V				88		
ADJ, $V_o = 5V$				82		
Switching Frequency	$f_{SX}$		47	52	58	kHz
			<b>43</b>		<b>62</b>	
Saturation Voltage <sup>(1)</sup>	$V_{SAT}$	LM2575, $I_o = 1A$		<b>0.9</b>	<b>1.2</b>	V
		LM2576, $I_o = 3A$		<b>0.9</b>	<b>1.4</b>	
Max. Duty Cycle (On) <sup>(3)</sup>	DC		93	98		%
Peak Current LM2575 <sup>(1)</sup>	$I_{CL}$		1.7	2.2	3.0	A
				<b>1.3</b>		
Peak Current LM2576 <sup>(1)</sup>	$I_{CL}$		4.2	5.8	6.9	A
				<b>3.5</b>		

**Electrical Characteristics (Cont.)**

Unless otherwise specified:  $V_{IN} = 12V$  for 3.3V, 5V and ADJ options and 25V for 12V option;  $V_{OUT} = 5V$  for ADJ option;  $T_A = 25^\circ C$ ;  $V_{IN\ rated} = 40V$ ;  $I_o = 0.5$  to 3A (LM2576), 0.2 to 1A (LM2575). Values in **bold** apply over full operating temperature range.

Parameter	Symbol	Test Conditions	Min	Typ	Max	Units
Output Leakage Current <sup>(2)</sup>						
Output = 0V	$I_L$	$V_{IN} = V_{IN\ Rated}$			2	mA
Output = -1V				7.5	30	
Quiescent Current <sup>(2)</sup>	$I_Q$			5	10	mA
					<b>12</b>	
Standby Quiescent Current (On/Off Pin = 5V)	$I_{STBY}$			50		$\mu A$
On/Off Pin Logic Input Level	$V_{IH}$		2.2	1.4		V
			<b>2.4</b>			
	$V_{IL}$			1.2	1.0	V
					<b>0.8</b>	
On/Off Pin Input Current	$I_{IH}$	$V_{ON/OFF} = 5V$ (Off)		12	30	$\mu A$
	$I_{IL}$	$V_{ON/OFF} = 0V$ (On)		0	10	

**Notes:**

- (1) Output sourcing current, resistive load, no inductor or capacitor.
- (2) Feedback =  $V_o + 1.0V$ .
- (3) Feedback = 0V.

### Pin Configurations

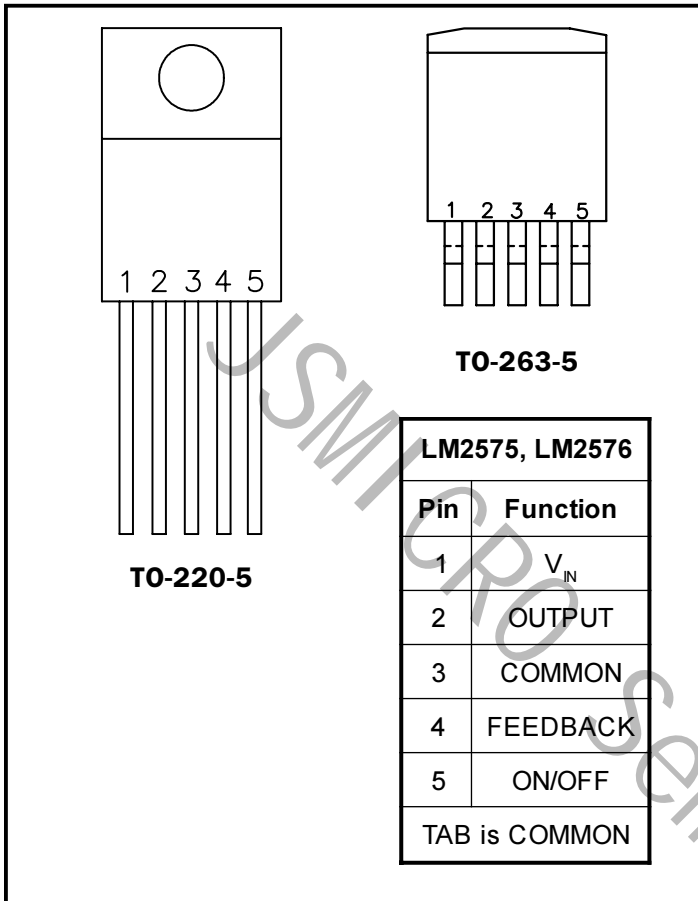

### Ordering Information

(1) -XX = Voltage Option. Available voltages are 3.3V (-3.3), 5V (-5.0), 12V (-12), and ADJ (-ADJ), which is adjustable between 1.23V and 35V.

### Block Diagram

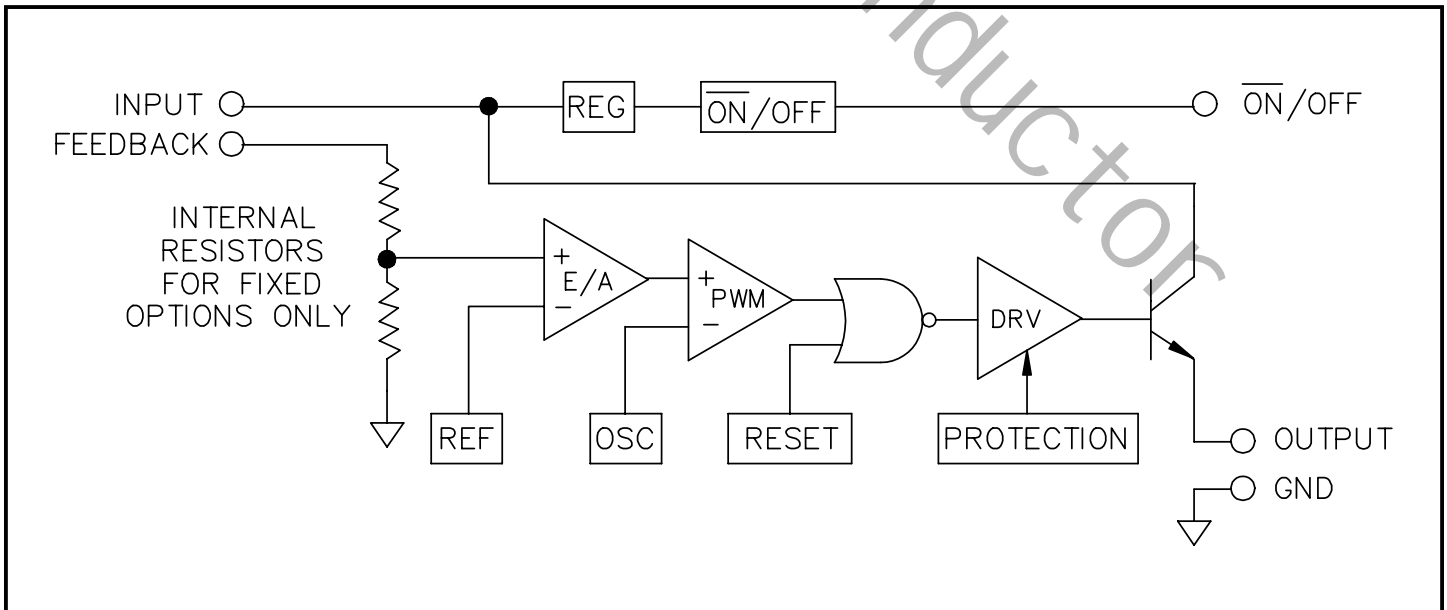

## Typical Characteristics - LM2575

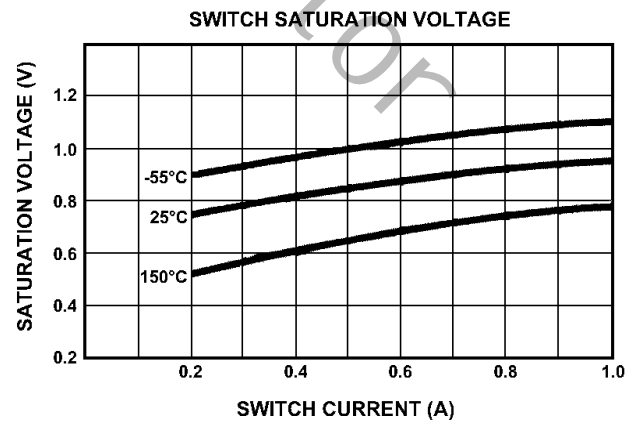
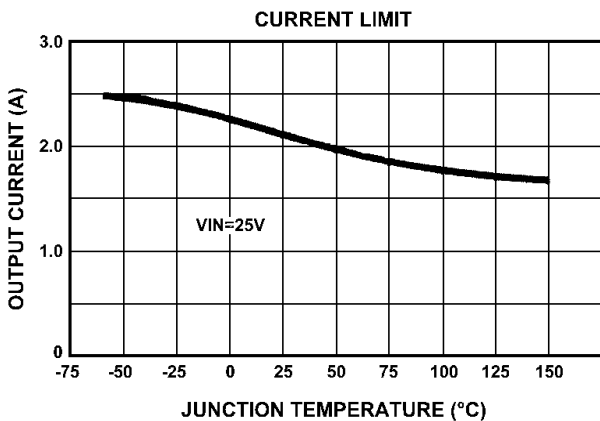
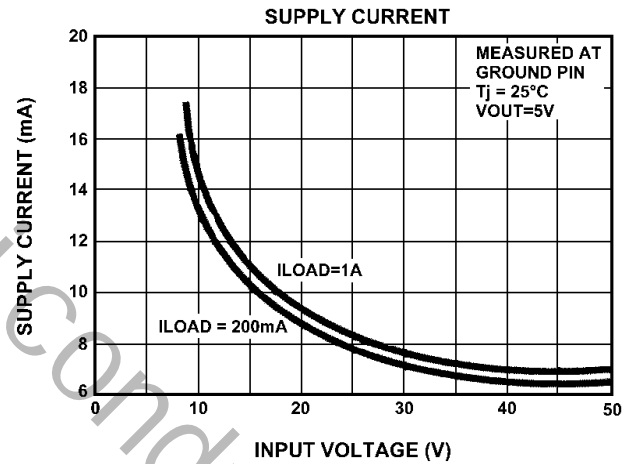
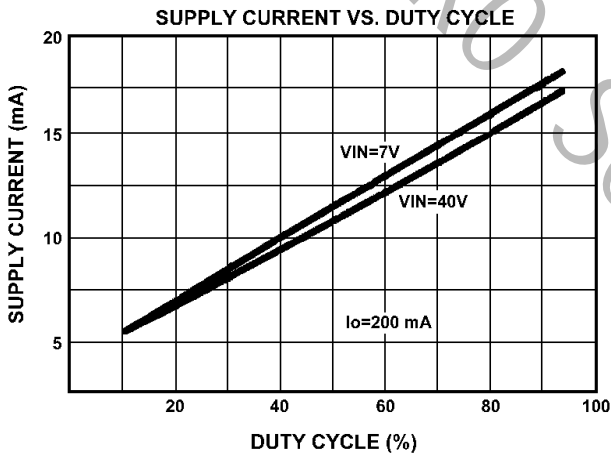
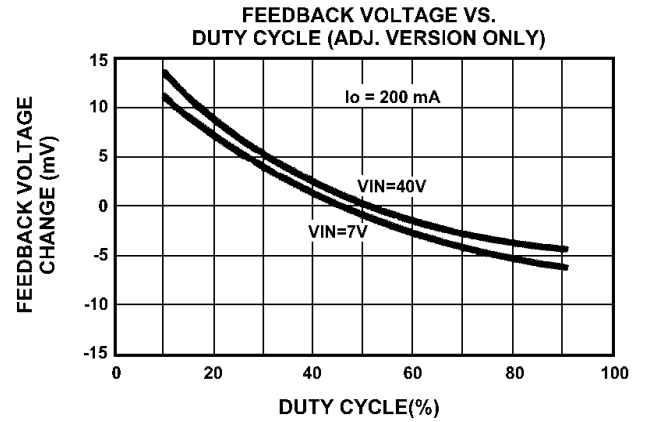
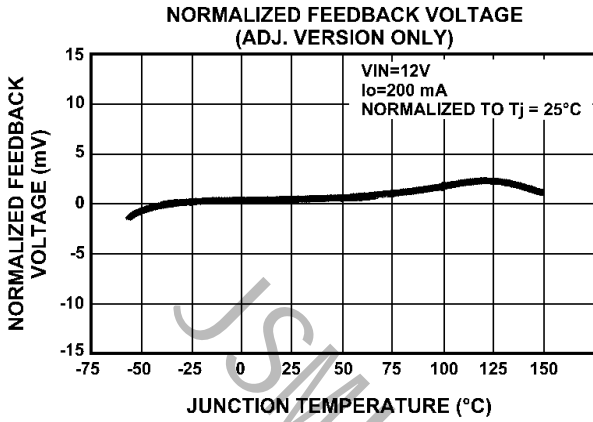

## Typical Characteristics - LM2575 (Cont.)

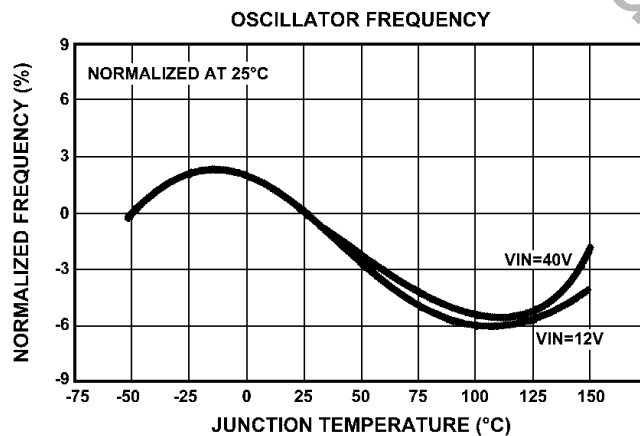
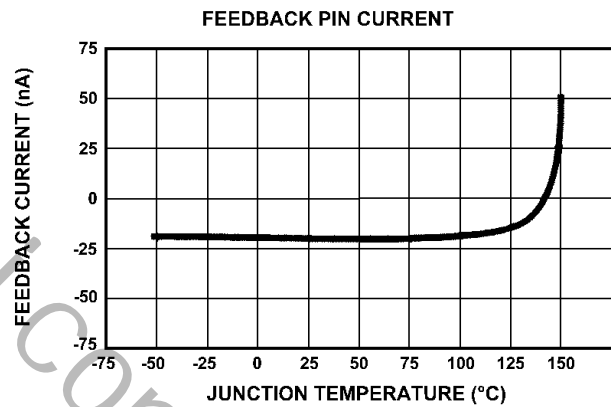
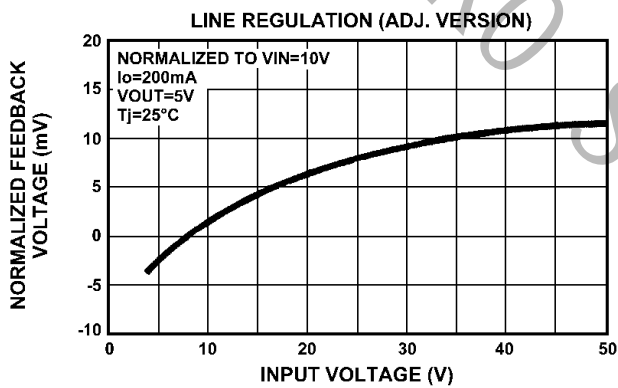
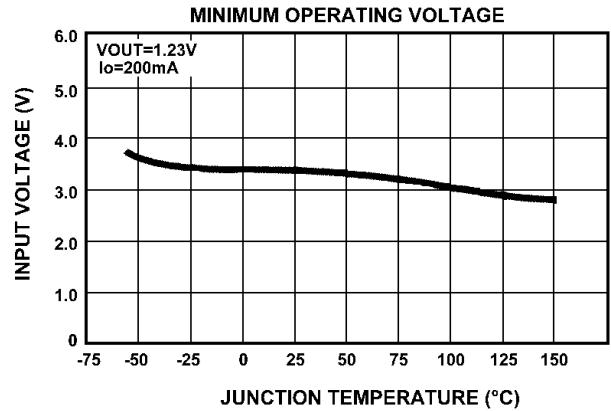
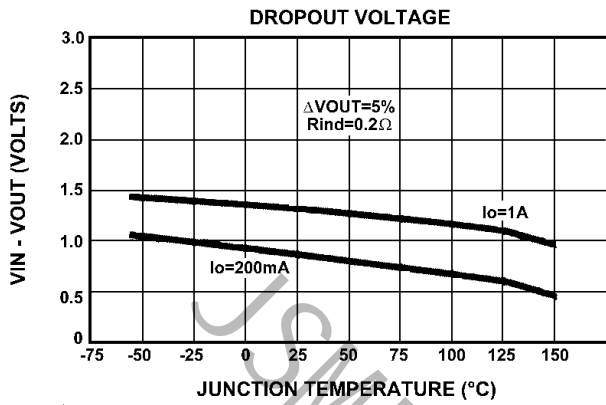

## Typical Characteristics - LM2575 (Cont.)

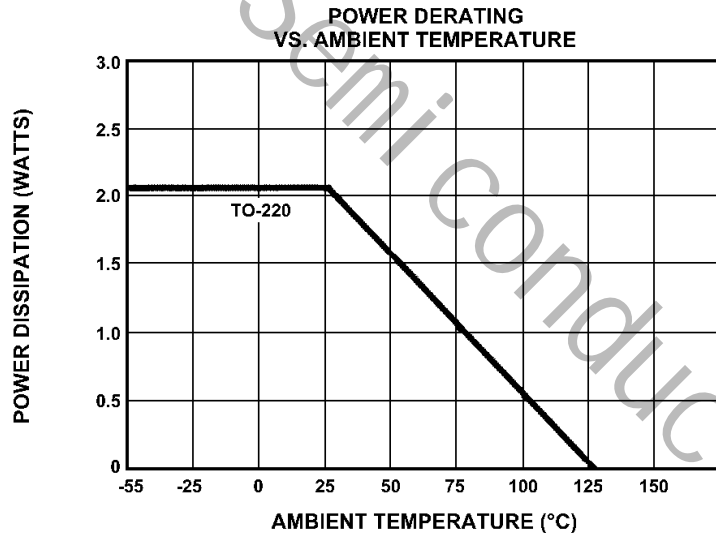
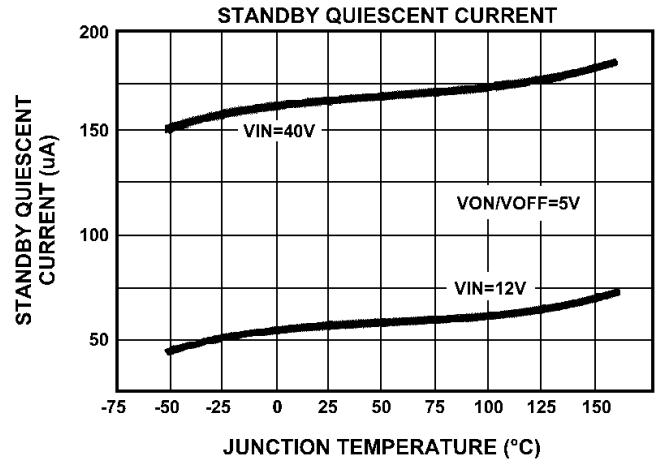
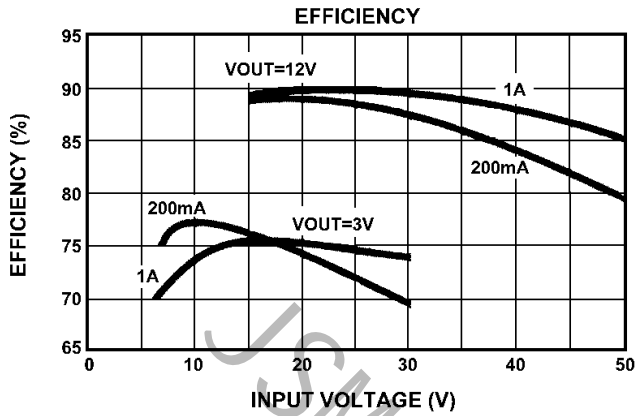



## Typical Characteristics - LM2576

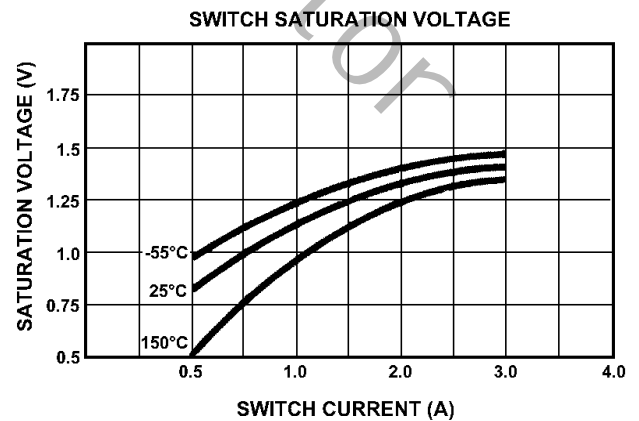
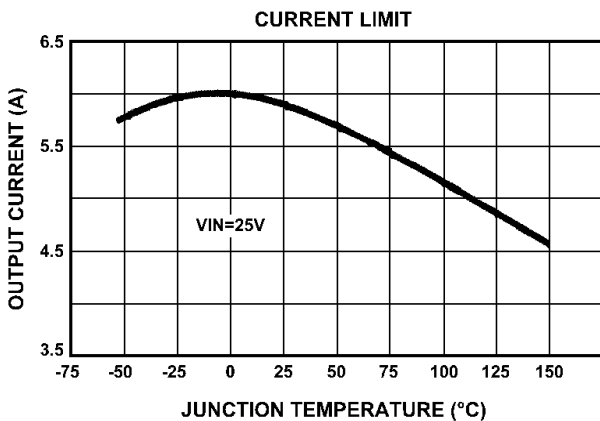
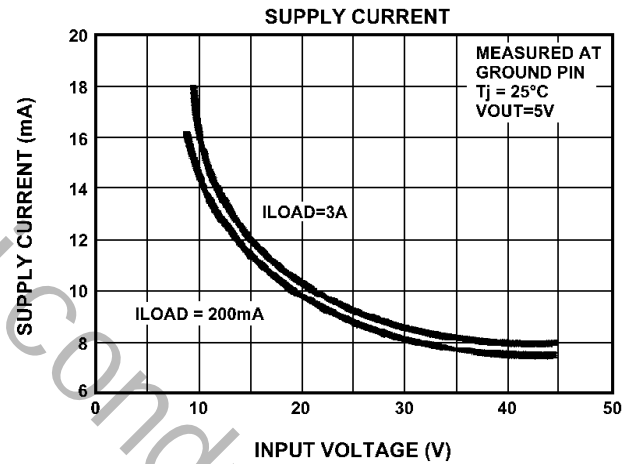
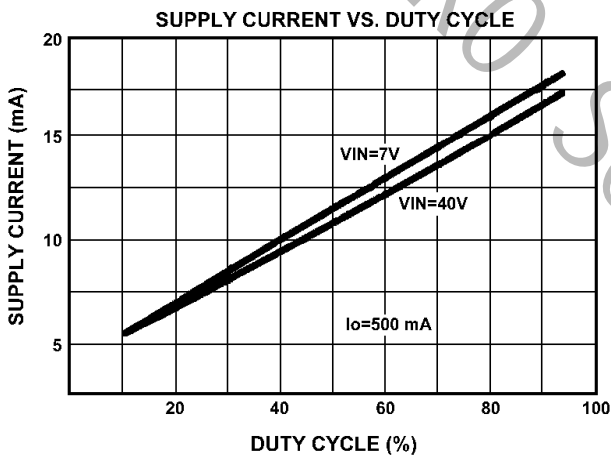
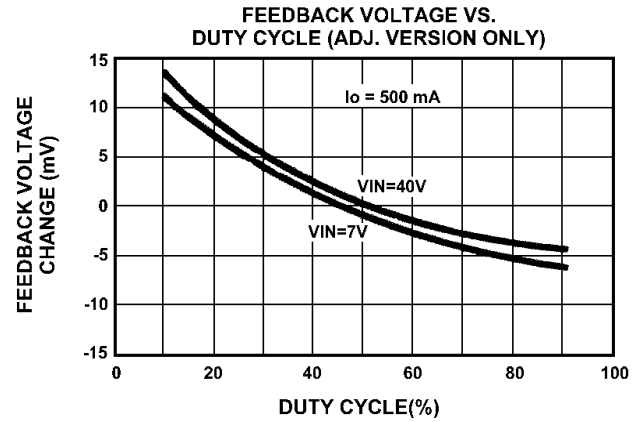
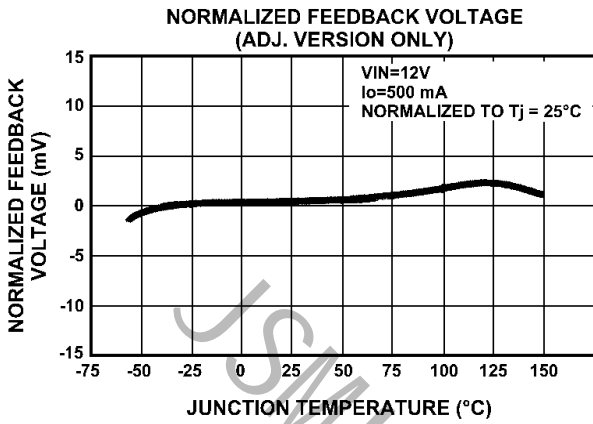

## Typical Characteristics - LM2576 (Cont.)

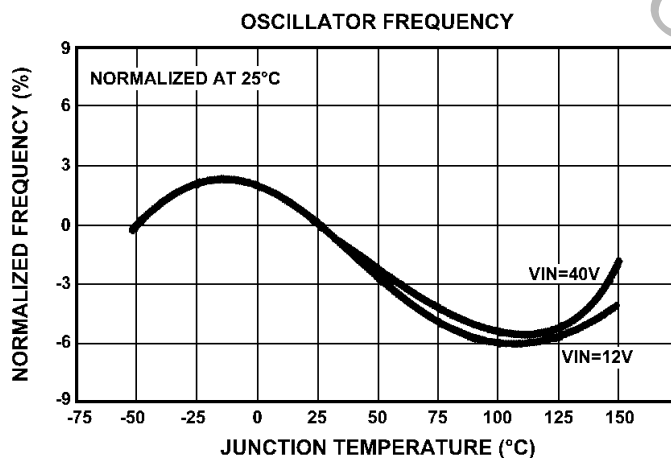
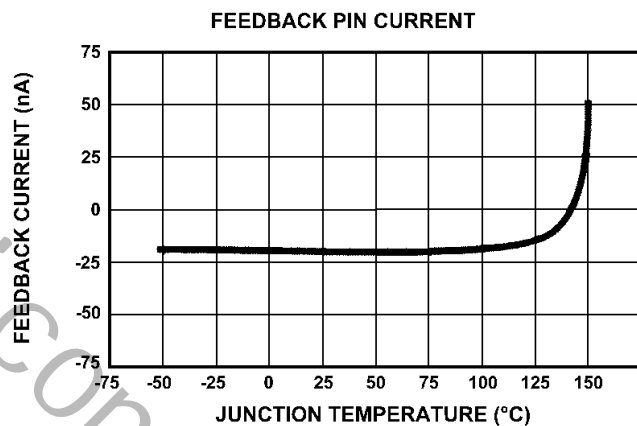
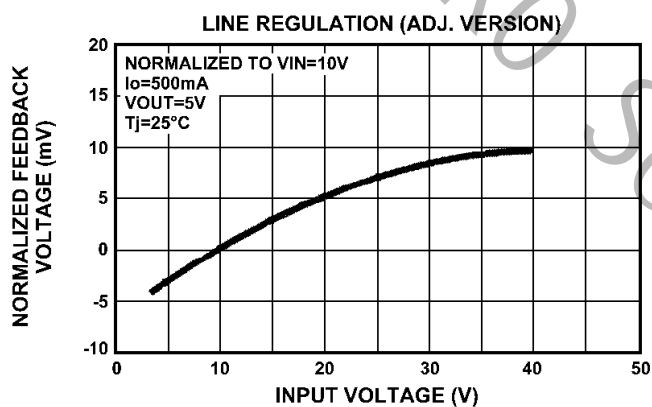
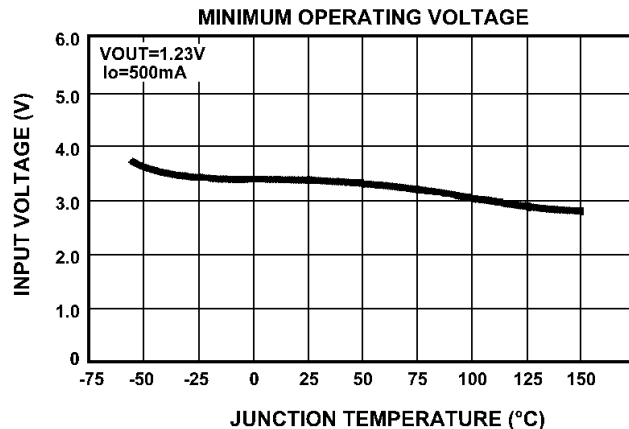
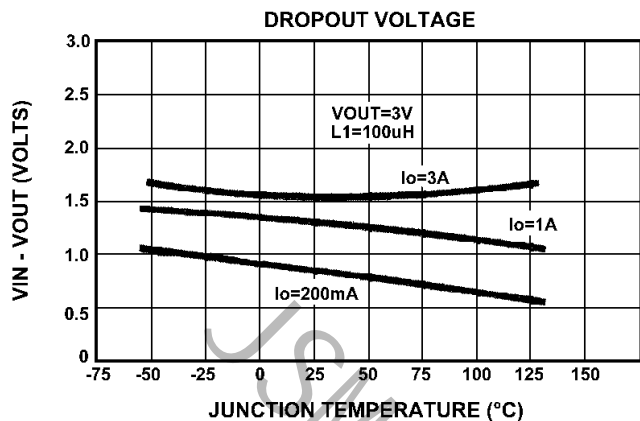

## Typical Characteristics - LM2576 (Cont.)

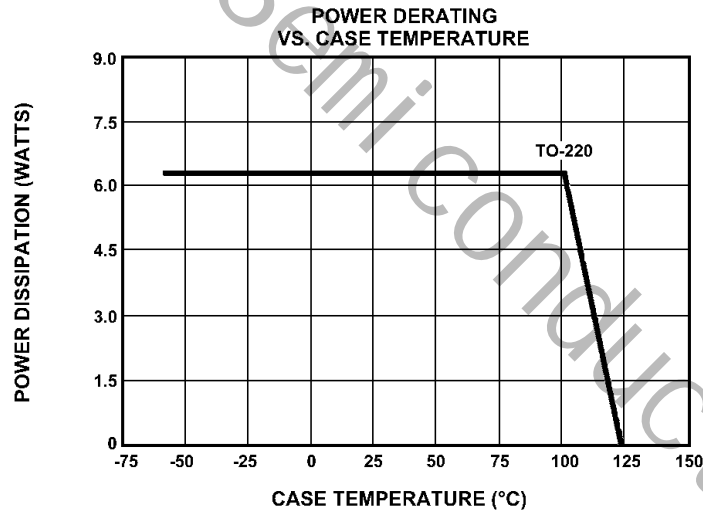
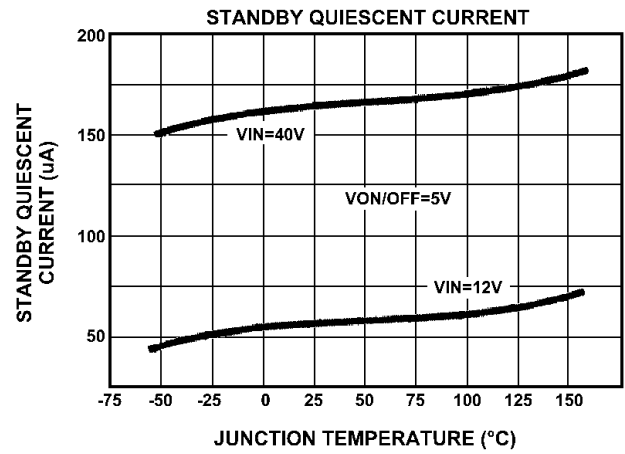
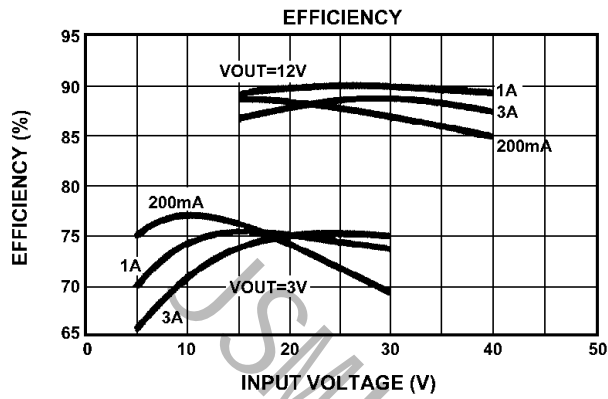

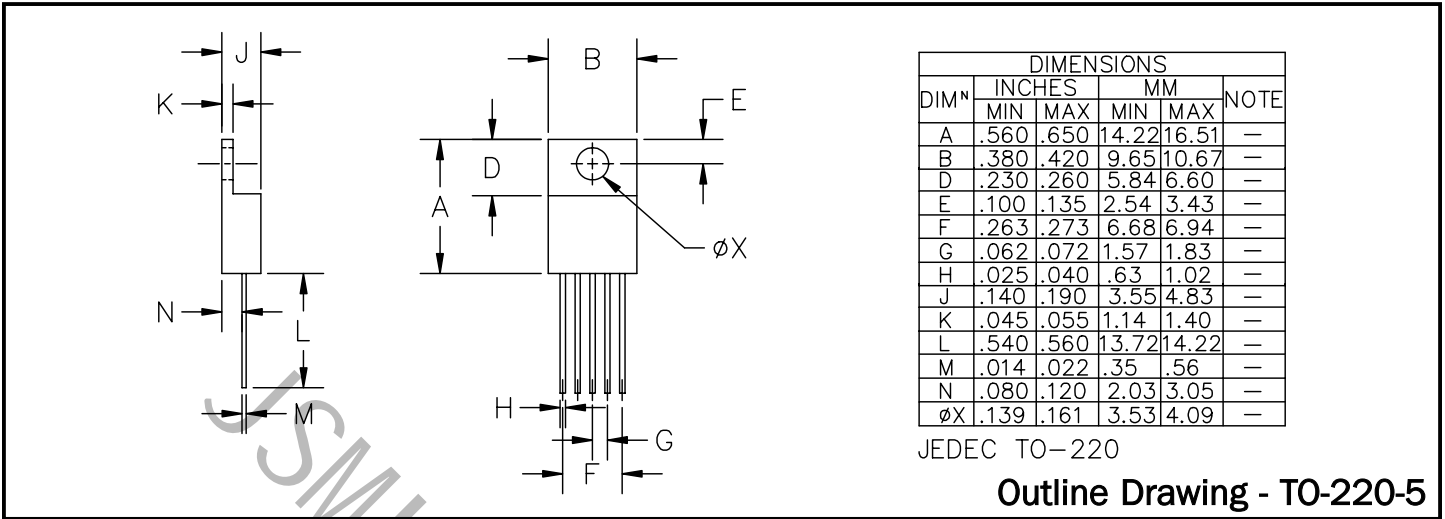

**Outline Drawing - TO-263-5**

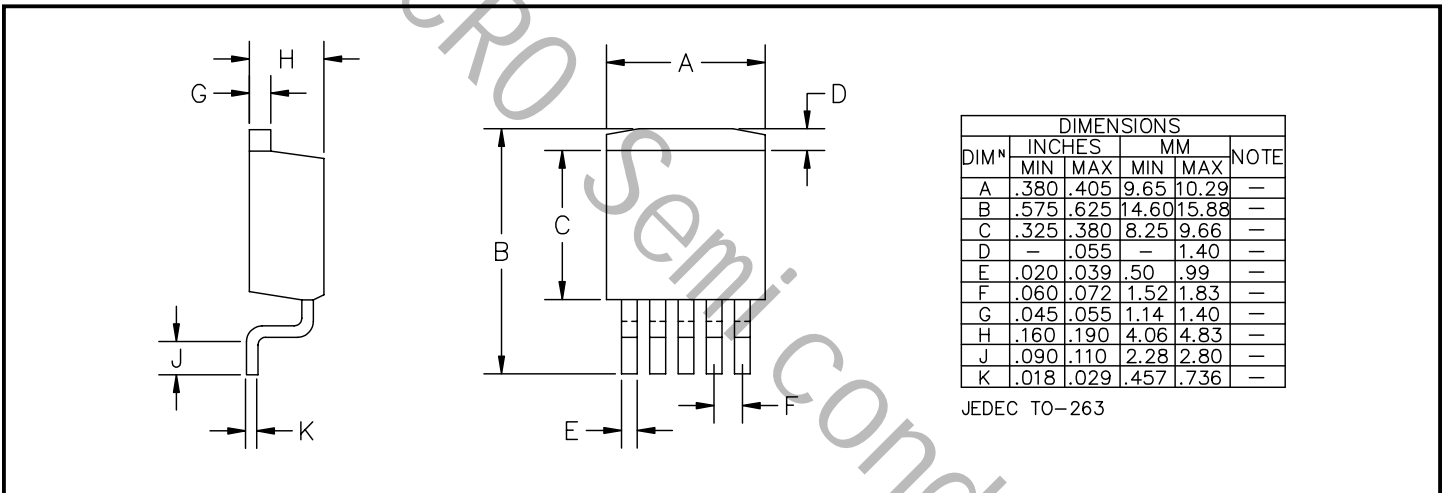

**Minimum Land Pattern - TO-263-5**

