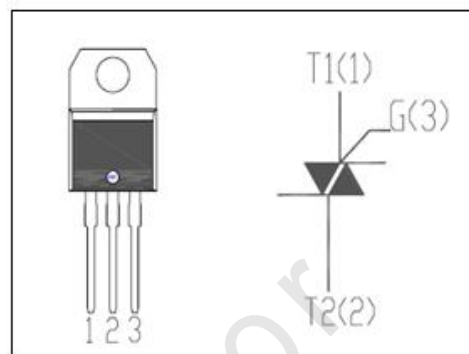

FEATURES

- With TO-220AB non insulated package
- Suitable for general purpose AC switching. Which can be used as an ON/OFF function in applications such as static relays, heating regulation, induction motor starting circuits. Or for phase control operation in light dimmers, motor speed controllers etc.

ABSOLUTE MAXIMUM RATINGS (Ta=25°C)

SYMBOL	PARAMETER	MIN	UNIT
V _{DRM}	Repetitive peak off-state voltage	800	V
V _{RRM}	Repetitive peak off-state voltage	800	V
I _{T(RMS)}	RMS on-state current (full sine wave)	8	A
I _{TSM}	Non-repetitive peak on-state current t _p =20ms	80	A
T _j	Operating junction temperature	125	°C
T _{stg}	Storage temperature	-40~150	°C
R _{th(j-c)}	Thermal resistance, junction to case	2.4	°C/W
R _{th(j-a)}	Thermal resistance, junction to ambient	60	°C/W

ELECTRICAL CHARACTERISTICS (T_c=25°C unless otherwise specified)

SYMBOL	PARAMETER	CONDITIONS	B	C	UNIT	
I _{RRM}	Repetitive peak reverse current	V _R =V _{RRM} , V _R =V _{RRM} , T _j =110°C	0.01 0.5	0.01 0.5	mA	
I _{DRM}	Repetitive peak off-state current	V _D =V _{DRM} , V _D =V _{DRM} , T _j =110°C	0.01 0.5	0.01 0.5	mA	
I _{GT}	Gate trigger current	V _D =12V; R _L = 30 Ω	I	50	25	mA
			II	50	25	
			III	50	25	
			IV	100	50	
I _H	Holding current	I _{GT} = 0.5A, Gate Open	50	25	mA	
V _{GT}	Gate trigger voltage all quadrant	V _D =12V; R _L = 30 Ω	1.3		V	
V _{TM}	On-state voltage	I _T = 11A; t _p = 380 μs	1.55		V	

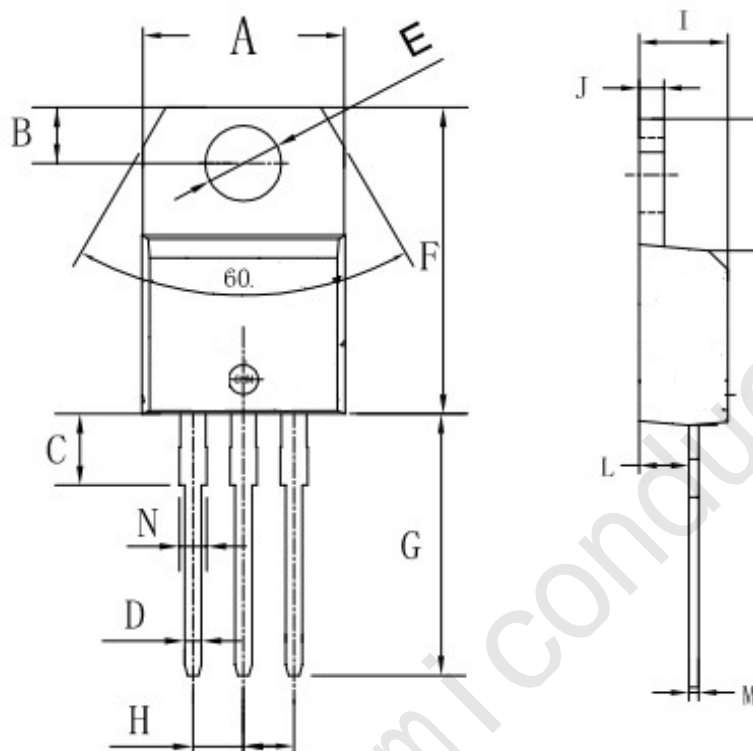
TO-220AB PACKAGE OUTLINE DIMENSIONS

Symbol	Dimensions In Millimeters		Dimensions In Inches	
	Min	Max	Min	Max
A	9.8	10.4	0.385	0.409
B	2.65	3.1	0.104	0.122
C	2.8	4.2	0.110	0.165
D	0.7	0.92	0.027	0.036
E	3.75	3.95	0.147	0.155
F	14.8	16.1	0.582	0.633
G	13.05	13.6	0.513	0.535
H	2.4	2.7	0.094	0.106
I	4.38	4.61	0.172	0.181
J	1.15	1.36	0.045	0.053
K	5.85	6.82	0.230	0.268
L	2.35	2.75	0.092	0.108
M	0.35	0.65	0.013	0.025
N	1.18	1.42	0.046	0.055