

修订 REV	标记 MARK	修改摘要 REVISION DESCRIPTION	签名 SIGNATURE	日期 DATE
AO		NEW DWG		2017-11-11

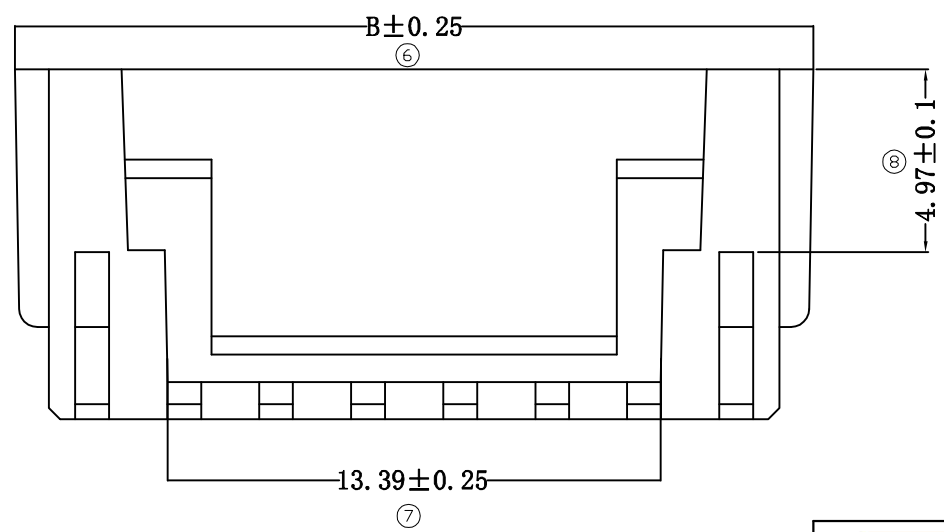
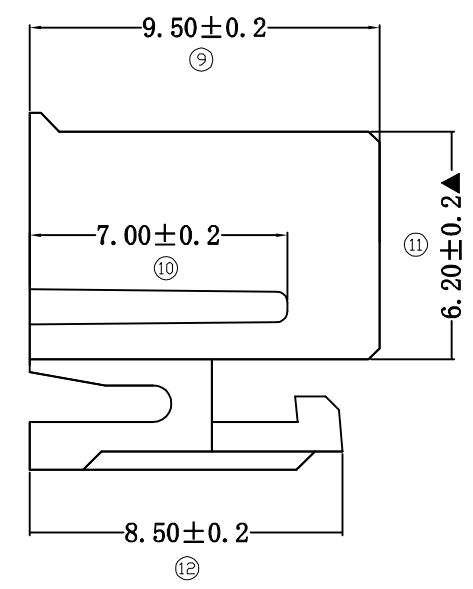
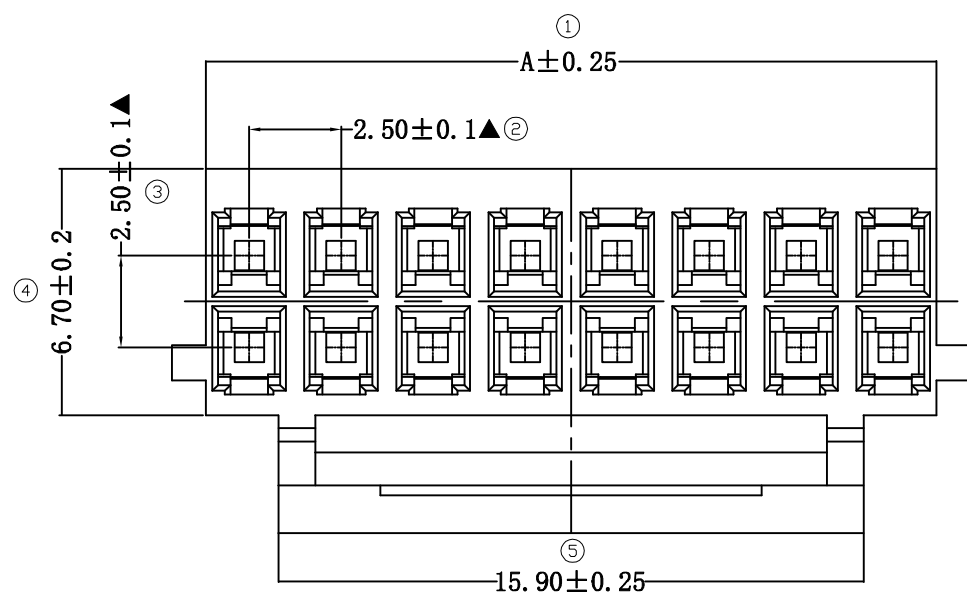

3	2X10P	24.85	26.70
2	2X9P	22.35	24.20
1	2X8P	19.85	21.70
序号	品名	A	B
		尺寸(mm)	

产品要求:

- 1、材质: PA66 黑色
UL94-V0;
- 2、尺寸: 所有尺寸均符合检测标准, ▲为重点尺寸;
- 3、包装: 最小包装量 1 K/包。

 深圳市华德共创科技有限公司 Shenzhen Huade co-create Technology Co.,LTD 电话: 0755-27129737 传真: 0755-29940187		TITLE: HXB2.5胶壳 产品名称:							
		PART NO: HDGC2522H-2xXP 产品编号:							
-TOLERANCES- UNLESS OTHERWISE SPECIFIED 公差参数表				DATE	SCALE	UNIT	CODE NUMBER		
X.X	±0.30			X.X'	±3'	DATE	SCALE	UNIT	CODE NUMBER
X.XX	±0.30			X.XX'	±2'	DATE	SCALE	UNIT	CODE NUMBER
X.XXX	±0.10	X.XXX'	±1'	DATE	SCALE	UNIT	CODE NUMBER		
APPD: 核准: 谢亮		DRAW: 绘图: 黄艳兰		2017-11-11	1:1	mm	A001		

修订 REV	标记 MARK	修改摘要 REVISION DESCRIPTION	签名 SIGNATURE	日期 DATE
AO		NEW DWG		2017-11-11

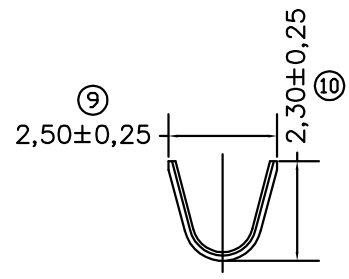
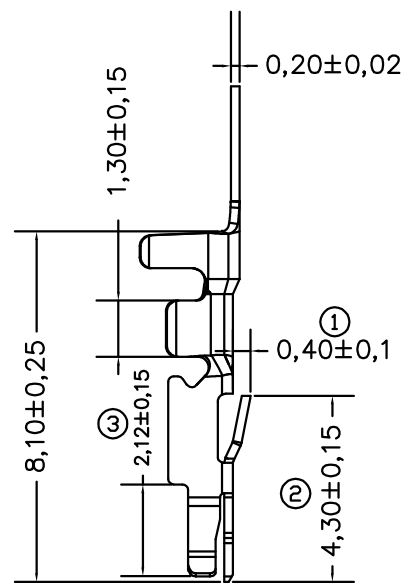
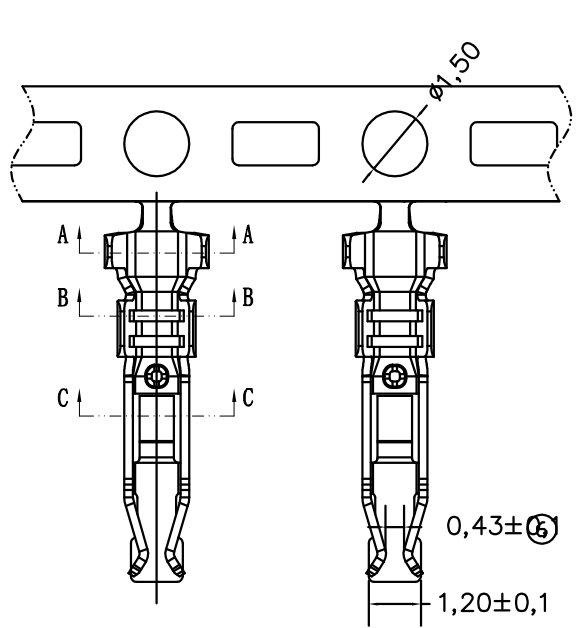

SECTION A-A

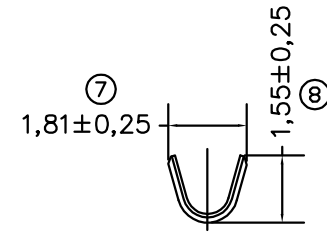

SECTION B-B

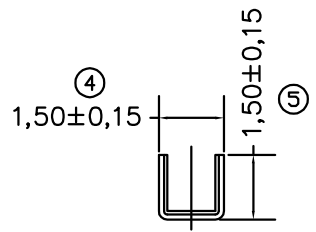

SECTION C-C

产品要求:

1. 材质要求: 磷铜C5191, 材厚: $T=0.20\pm0.02\text{MM}$;
2. 包装要求: 每盘10K, 接头数不能超过2个;
3. 电镀要求: 先冲后镀, 镀全锡 $50\sim 80\mu$, Ni底 $20\sim 40\mu$; 盐雾实验为最少达到12小时以上。



深圳市华德共创科技有限公司
Shenzhen Huade co-create Technology Co.,LTD
电话: 0755-27129737 传真: 0755-29940187

-TOLERANCES- UNLESS OTHERWISE SPECIFIED 公差参数表				TITLE: 产品名称: HXB2.5-TER				
X.X	±0.30	X.X*	±3*	APPD: 核准: 谢亮	PART NO: 产品编号: HDGC2522-T			
X.XX	±0.30	X.XX*	±2*	CHECK: 校对: 王建业	DATE	SCALE	UNIT	CODE NUMBER
X.XXX	±0.10	X.XXX*	±1*	DRAW: 绘图: 黄艳兰	2017-11-11	1:1	mm	A001