

修 改	记号	内 容	修改者	日期

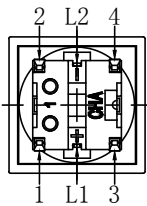

### CIRCUIT

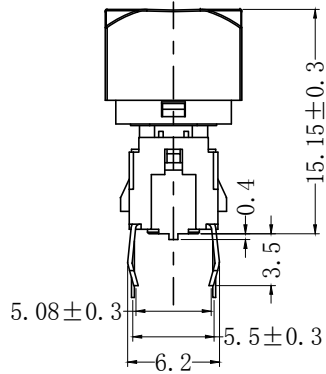
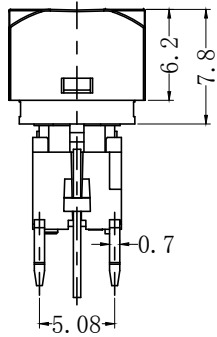
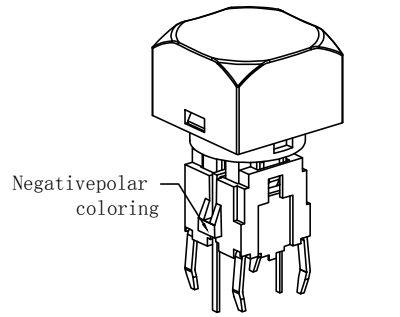
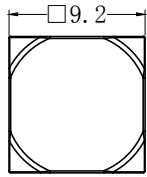
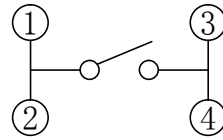

### P. C. B. LAYOUT

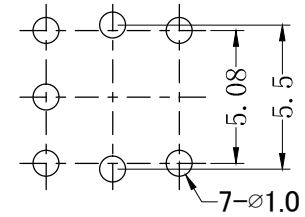

C360 0	T	R	N1	N
Shapesize	CapColor	FlatheadLEDcolor	Operatingforce	Pattern
0 9.2×9.2	T Transparent	0 Without	N1 160gf	N Without
1 11×11	R Red	1 Red	N2 250gf	X Attachmentlist
2 12×12	G Green	2 Yellow		
3 ∅13 Round	Y Yellow	3 Green		
4 15×15*		4 Blue		
		5 White		
		6 PureGreen		
		7 Amber		
		12 RedYellow		
		13 RedGreen		
		23 YellowGreen		

If you have any other requirements, please ask the sales representative for details.

- 1.RATING:12VDC50mA.
- 2.INSULATION RESISTANCE :100MΩ Min(250VDC).
- 3.DIELECTRICSTRENGTH:250VAC5060Hzfor1min.
- 4.CONTACT RESISTANCE :100mΩ Max.
- 5.ELECTRICALLYLIFE:100,000cycles.
- 6.OPERATING TEMPERATURE RANGE :-20°C~+70°C.
- 7.OPERATING FORCE :160±50g / 250±50g.
- 8.TRAVEL :0.25±0.1 mm
- 9.ITISRECOMMENDEDTHATTHENUMBEROFTIMESTO PULLOUTTHECAPSHOULDNOTEXCEED3

序号	零件名称	材质	数量	备注	Color	VR	IF	Recommended Operating Current	VF		
									Nom.	Max	
1	透明盖	PC	1	透明	Red	DC 5V	20mA	20mA	2.0 V	2.4 V	
2	散光片	PC	1	白色	Yellow	DC 5V	20mA	20mA	2.3 V	2.5 V	
3	上 盖	PC	1	白色	Green	DC 5V	20mA	20mA	2.4 V	2.7 V	
4	推 柄	尼龙	1	白色	Blue	DC 5V	20mA	20mA	3.3 V	3.6 V	
5	底座	塑胶	尼龙	1	黑色	White	DC 5V	20mA	20mA	3.0 V	3.6 V
		端子	黄铜	1	镀银	Full Green	DC 5V	20mA	20mA	3.0 V	3.6 V
6	弹 片	不锈钢	1		Amber	DC 5V	20mA	20mA	2.3 V	2.5 V	
7	LED灯		1								

本公司智慧财产，未经同意不得复制  
Without permission, copying is strictly prohibited. Chau-hua

ALLDIMENSIONS AREIN MILLIMETERS, GENERAL TOLERANCESMAX. ± 0.20mm.

制图	HH	比例		日期	
设计	HH	单位	MM	材质	
校对	LZY	全周倒角		数量	
审核	MW	视图		处理	

昭华集团(香港)有限公司  
CHAU-HUA GROUP (HONGKONG) CO., LIMITED

名称	C3600
型号	C3600-T-1-N2-N