

### Description

The TP8009S6 is a high-efficiency, DC-to-DC step-down switching regulators, capable of delivering up to 2A of output current. The device operates from an input voltage range of 2.5V to 6.0V and provides an output voltage from 0.6V to VIN, making the TP8009S6 ideal for low voltage power conversions. Running at a fixed frequency of 1.3MHz allows the use of small external components, such as ceramic input and output caps, as well as small inductors, while still providing low output ripples. This low noise output along with its excellent efficiency achieved by the internal synchronous rectifier, making TP8009S6 an ideal green replacement for large power consuming linear regulators. Internal soft-start control circuitry reduces inrush current. Short-circuit and thermal-overload protection improves design reliability. The TP8009S6 is available in a SOT23-6 Package

### Features

- High Efficiency: Up to 97%
- Capable of Delivering 2A
- 1.3MHz Switching Frequency
- No External Schottky Diode Needed
- Light-load Mode
- Internal Compensation and Soft-Start
- Current Mode control
- 0.6V Reference for Low Output voltages
- Logic Control Shutdown (IQ<1uA)
- Thermal shutdown and UVLO
- Available in SOT23-6

### Application

- Digital Cameras
- MP3 and MP4 players
- Set top boxes
- Wireless and DSL Modems
- USB supplied Devices in Notebooks
- Portable Devices.

### Packaging Type

SOT-23-6

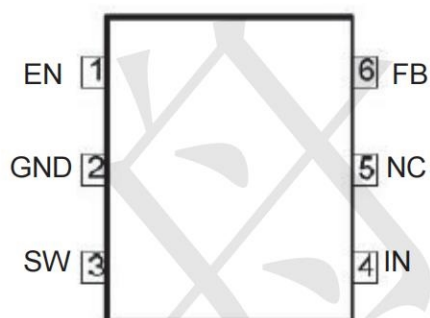

### Marking: Bxyy

“ B ” is part number ,fixed  
“ xyy ” is internal code

SOT-23-6	Description	Function
1	EN	Enable pin
2	GND	Ground
3	SW	Power Switch Output
4	IN	Power Supply Input
5	NC	Not Connected
6	FB	Feedback input pin

### Absolute Maximum Rating

Parameter		Value
Max Input Voltage		6V
Max Operating Junction Temperature(Tj)		125°C
Ambient Temperature(Ta)		-40°C~+85°C
Maximum Power Dissipation	SOT-23-6	400mW
Storage Temperature(Ts)		-40°C~150°C
Lead Temperature & Time		260°C 10S
TAPE & REEL		3000/REEL

Note1: Absolute Maximum Ratings indicate limits beyond which damage to the device may occur. Recommended Operating Range indicates conditions for which the device is functional, but do not guarantee specific performance limits. Electrical Characteristics state DC and AC electrical specifications under particular test conditions which guarantee specific performance limits. This assumes that the device is within the Operating Range. Specifications are not guaranteed for parameters where no limit is given, however, the typical value is a good indication of device performance.

**Typical Application**

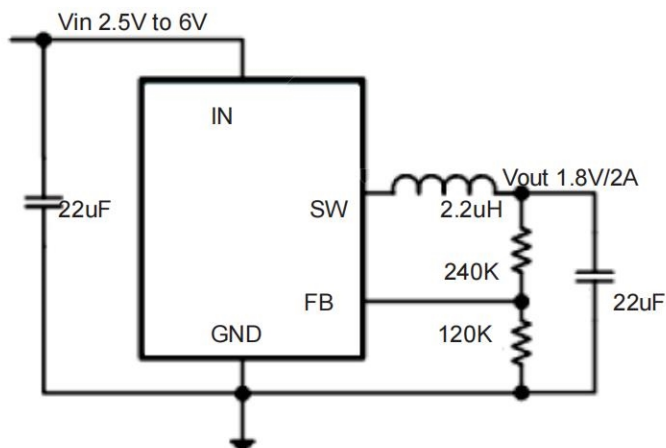

SYMBOL	DESCRIPTION	Value	Unit
VIN	VIN Supply Voltage	2.5 to 6	V
TOPT	Operating Temperature	-40 to +85	°C

**SIMPLIFIED BLOCK DIAGRAM**

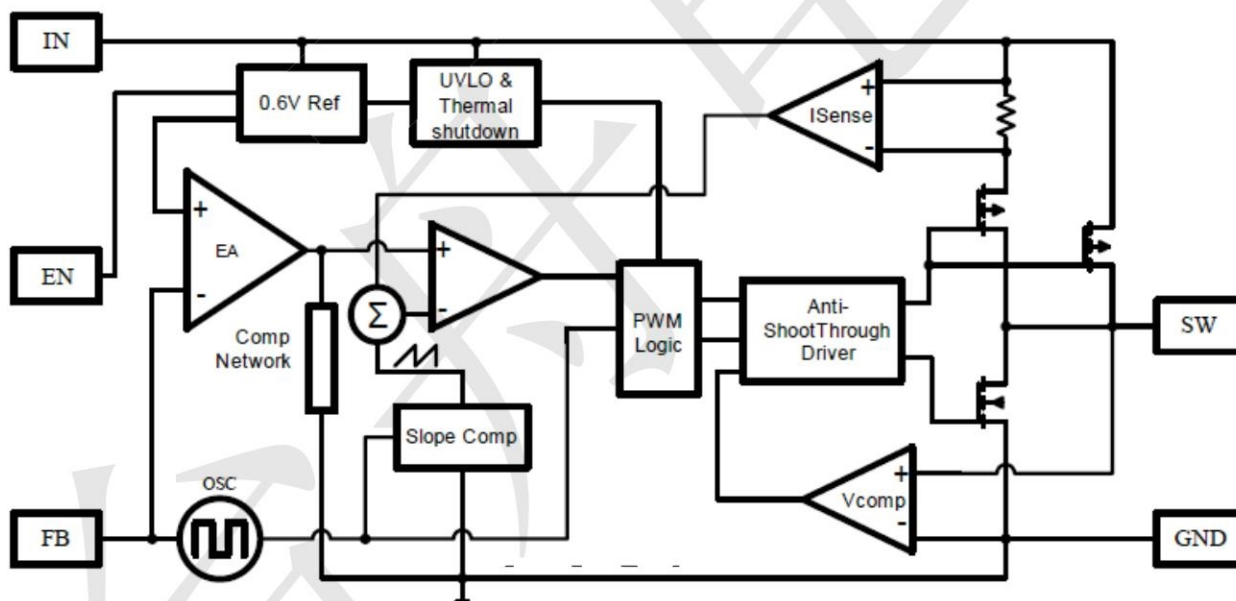

### Electrical Characteristics

$V_{DD}=5V, T_A=25^{\circ}C$

Symbol	Parameter	Conditions	Min	Typ	Max	Unit
$V_{IN}$	Input Voltage Range		2.5		6.0	V
$V_{FB}$	Feedback Voltage		0.585	0.6	0.615	V
$I_{FB}$	Feedback Leakage current			0.1	0.4	$\mu A$
$I_Q$	Quiescent Current	Active, $V_{FB}=0.65V$		50		$\mu A$
$I_{SD}$	Shutdown Current	Shutdown			1	$\mu A$
$F_{SW}$	Switching Frequency			1.3		MHz
$R_{ONP}$	PMOSFET $R_{DS(ON)}$			120		$m\Omega$
$R_{ONN}$	NMOSFET $R_{DS(ON)}$			80		$m\Omega$
$I_{LIMIT}$	Peak Current Limit		2.5			A
$I_{SW}$	SW Leakage Current	$V_{IN}=6.0V, V_{SW}=0$ or $6.0V, V_{EN}=0V$			10	$\mu A$
$I_{EN}$	EN Leakage Current				1	$\mu A$
$V_{ENH}$	EN Input High Voltage		1.5			V
$V_{ENL}$	EN Input Low Voltage				0.4	V
TSD	Thermal Shutdown			150		$^{\circ}C$
HYSTSD	Thermal Shutdown Hysteresis			15		$^{\circ}C$

## Typical Characteristics

(Typical values are at TA=25°C unless otherwise specified)

### 1. Efficiency

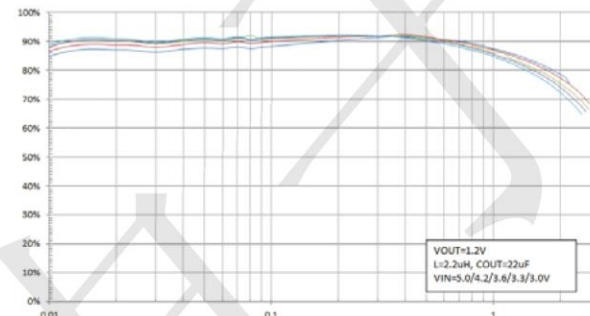
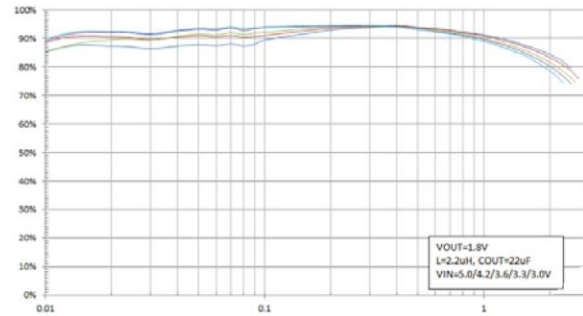
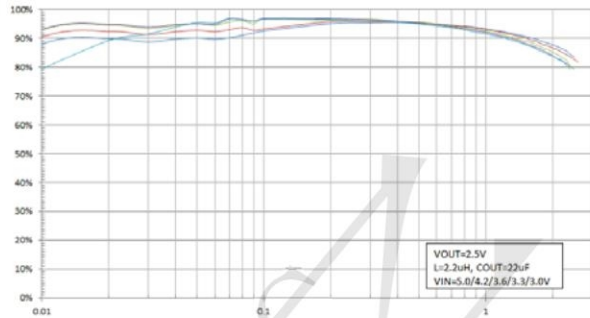
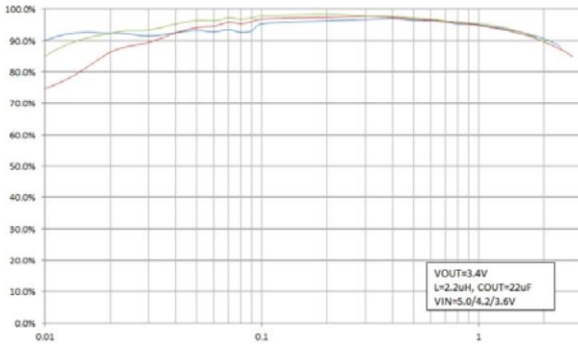

### 2. Load Regulation

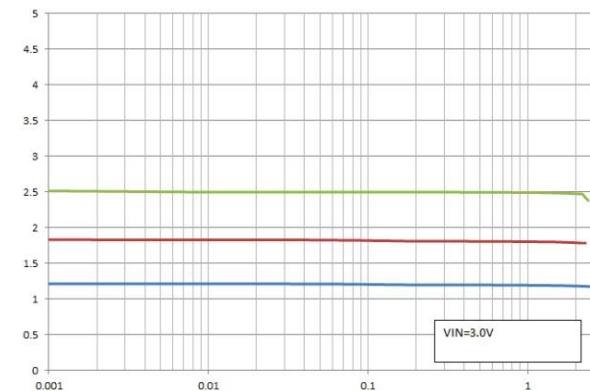
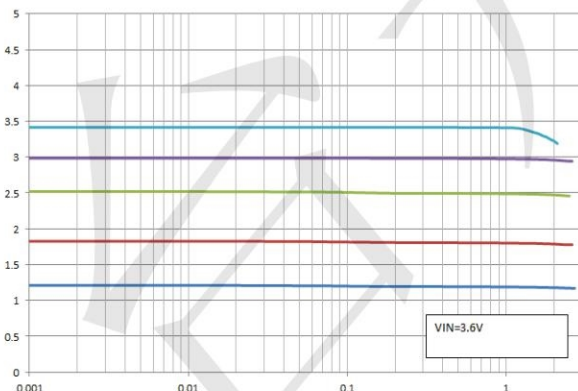
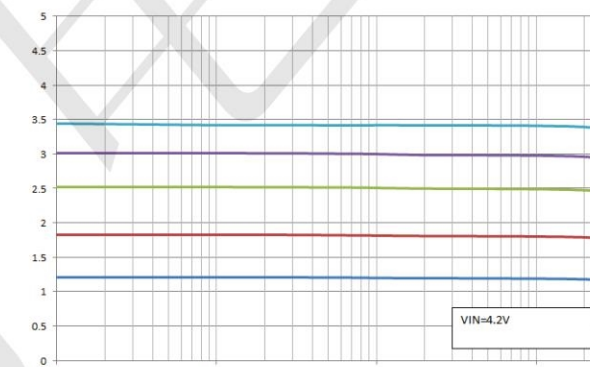
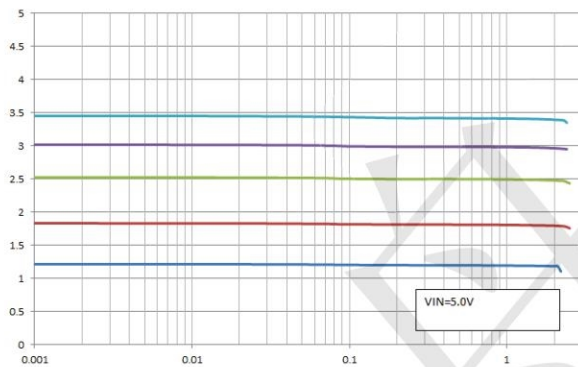

### Typical Characteristics

(Typical values are at TA=25°C unless otherwise specified)

#### 3. Line Regulation

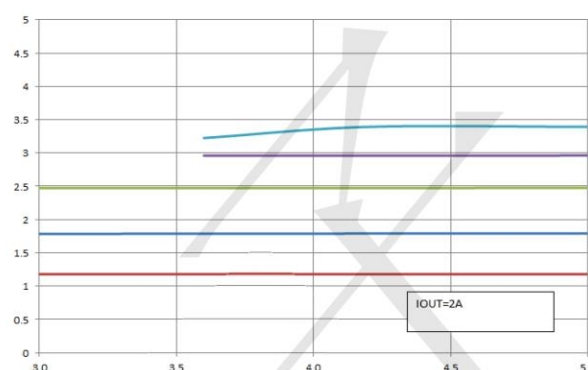
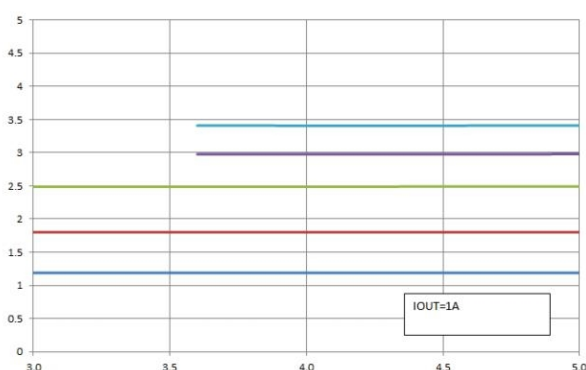

#### 4. Ripple for light-load and normal load

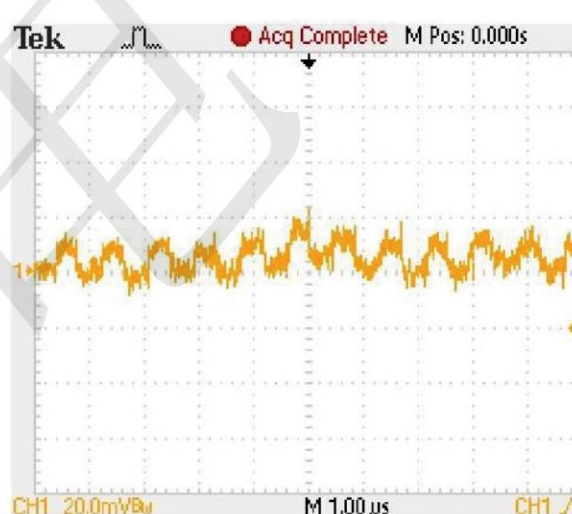
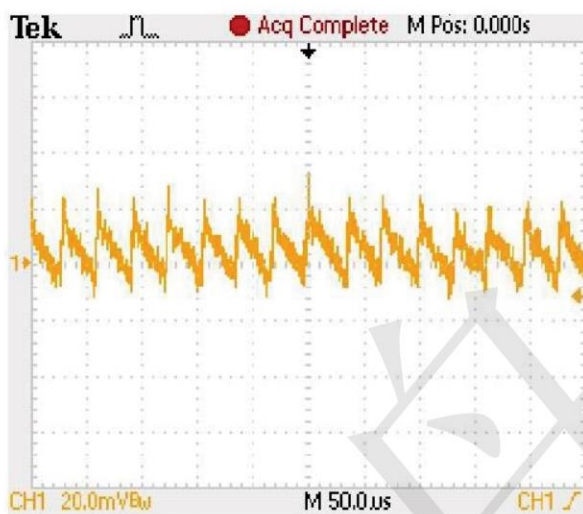

**Typical Characteristics**

(Typical values are at TA=25°C unless otherwise specified)

5. SW and VOUT for light-load and normal load

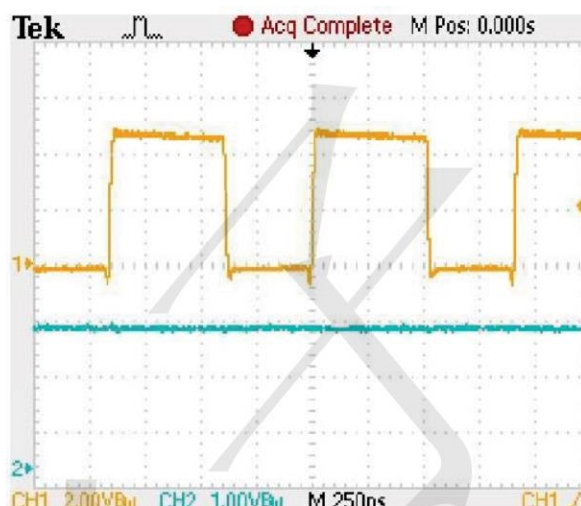
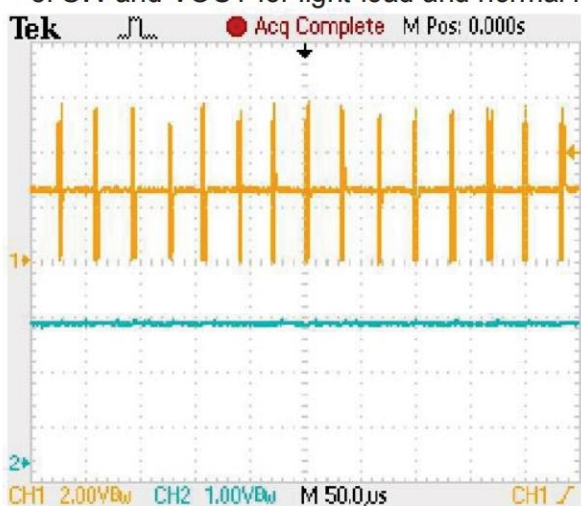

6. Transient for 0 to 2A and 0.5A to 2A

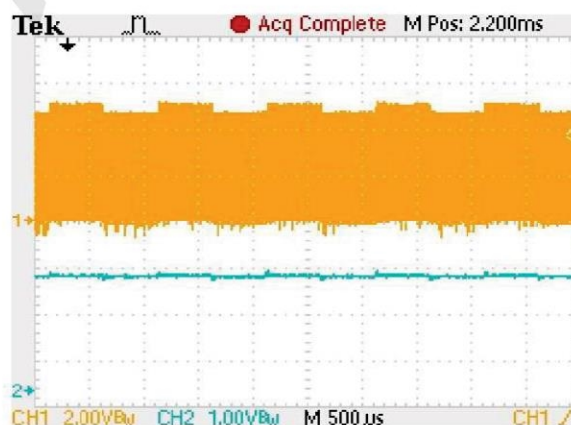

### Typical Characteristics

(Typical values are at TA=25°C unless otherwise specified)

#### 7. Soft Start for VOUT and SW

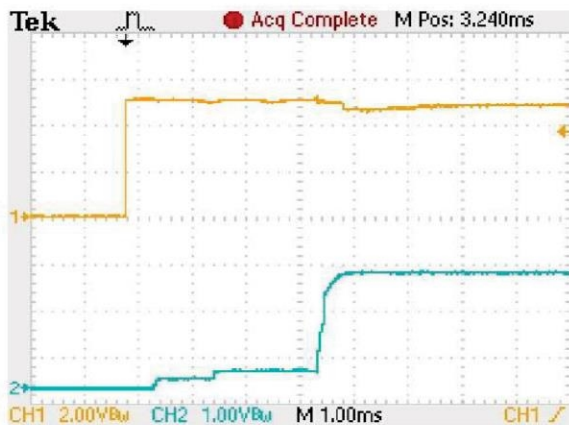

#### 8. Short Circuit Protection

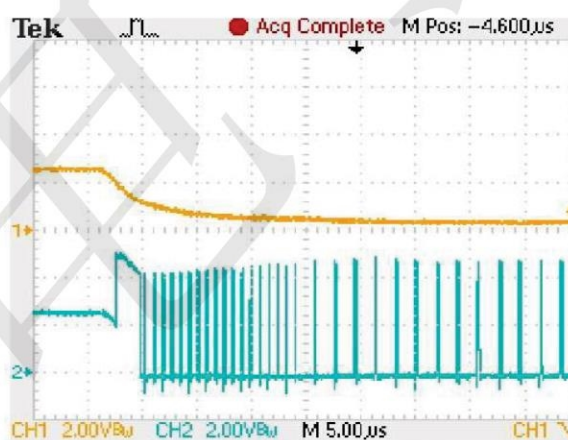
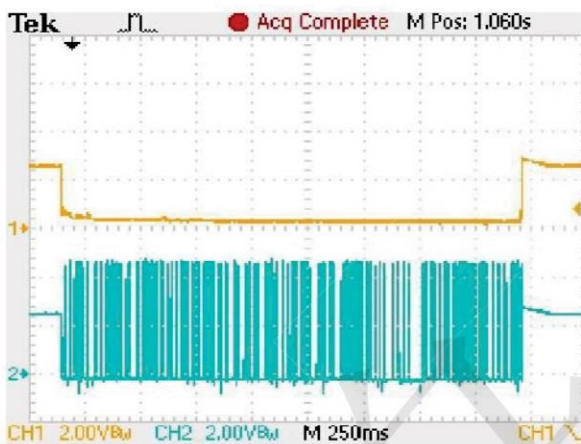

#### 9. Over-Thermal Protection and Recovery





## OPERATION DESCRIPTION

The TP8009S6 high-efficiency switching regulator is a small, simple, DC-to-DC step-down converter capable of delivering up to 2A of output current. The device operates in pulse-width modulation (PWM) at 1.3MHz from a 2.5V to 6.0V input voltage and provides an output voltage from 0.6V on, making the TP8009S6 ideal for on-board post-regulation applications. An internal synchronous rectifier improves efficiency and eliminates the typical Schottky free-wheeling diode. Using the on resistance of the internal high-side MOSFET to sense switching currents eliminates current-sense resistors, further improving efficiency and cost.

### Loop Operation

TP8009S6 uses a PWM current-mode control scheme. An open-loop comparator compares the integrated voltage-feedback signal against the sum of the amplified current-sense signal and the slope compensation ramp. At each rising edge of the internal clock, the internal high-side MOSFET turns on until the PWM comparator terminates the on cycle. During this on-time, current ramps up through the inductor, sourcing current to the output and storing energy in the inductor. The current mode feedback system regulates the peak inductor current as a function of the output voltage error signal. During the off cycle, the internal high-side P-channel MOSFET turns off, and the internal low-side N-channel MOSFET turns on. The inductor releases the stored energy as its current ramps down while still providing current to the output.

### Current Sense

An internal current-sense amplifier senses the current through the high-side MOSFET during on time and produces a proportional current signal, which is used to sum with the slope compensation signal. The summed signal then is compared with the error amplifier output by the PWM comparator to terminate the on cycle

### Current Limit

There is a cycle-by-cycle current limit on the high-side MOSFET of 2.5A. When the current flowing out of SW exceeds this limit, the high-side MOSFET turns off and the synchronous rectifier turns on. TP8009S6 utilizes a frequency fold-back mode to prevent overheating during short-circuit output conditions. The device enters frequency fold-back mode when the FB voltage drops below 200mV, limiting the current to 2.5A and reducing power dissipation. Normal operation resumes upon removal of the short-circuit condition.

## Soft-start

TP8009S6 has a internal soft-start circuitry to reduce supply inrush current during startup conditions. When the device exits under-voltage lockout (UVLO), shutdown mode, or restarts following a thermal-overload event, the I soft-start circuitry slowly ramps up current available at SW.

## UVLO and Thermal Shutdown

If IN drops below 2.5V, the UVLO circuit inhibits switching. Once IN rises above 2.5V, the UVLO clears, and the soft-start sequence activates. Thermal-overload protection limits total power dissipation in the device. When the junction temperature exceeds  $T_J = +150^{\circ}\text{C}$ , a thermal sensor forces the device into shutdown, allowing the die to cool. The thermal sensor turns the device on again after the junction temperature cools by  $15^{\circ}\text{C}$ , resulting in a pulsed output during continuous overload conditions. Following a thermal-shutdown condition, the soft-start sequence begins.

## APPLICATION INFORMATION

### Setting Output Voltages

Output voltages are set by external resistors. The FB\_ threshold is 0.6V.

$$R_{\text{TOP}} = R_{\text{BOT}} [(V_{\text{OUT}} / 0.6) - 1]$$

### Input Capacitor Selection

The input capacitor in a DC-to-DC converter reduces current peaks drawn from the battery or other input power source and reduces switching noise in the controller. The impedance of the input capacitor at the switching frequency should be less than that of the input source so high-frequency switching currents do not pass through the input source. The output capacitor keeps output ripple small and ensures control-loop stability. The output capacitor must also have low impedance at the switching frequency. Ceramic, polymer, and tantalum capacitors are suitable, with ceramic exhibiting the lowest ESR and high-frequency impedance. Output ripple with a ceramic output capacitor is approximately as follows:

$$V_{\text{RIPPLE}} = I_{\text{L(PEAK)}} [1 / (2\pi \times f_{\text{OSC}} \times C_{\text{OUT}})]$$

If the capacitor has significant ESR, the output ripple component due to capacitor ESR is as follows:

$$V_{\text{RIPPLE(ESR)}} = I_{\text{L(PEAK)}} \times \text{ESR}$$

### Output Capacitor and Inductor Selection

Follow the below table for Inductor and Output cap selection:

$V_{OUT}$	1.2V	1.5V	1.8V	2.5V	3.3V
$C_{OUT}$	33 F	33 F	22 F	22 F	10 F
L	1.5 H	1.5 H	2.2 H	3.3 H	4.7 H

If much smaller values are used, inductor current rises, and a larger output capacitance may be required to suppress output ripple. Larger values than LIDEAL can be used to obtain higher output current, but typically with larger inductor size.

### Application Information

Layout is critical to achieve clean and stable operation. The switching power stage requires particular attention. Follow these guidelines for good PC board layout:

- (1) Place decoupling capacitors as close to the IC as possible
- (2) Connect input and output capacitors to the same power ground node with a star ground configuration then to IC ground.
- (3) Keep the high-current paths as short and wide as possible. Keep the path of switching current (C1 to IN and C1 to GND) short. Avoid vias in the switching paths.
- (4) If possible, connect IN, SW, and GND separately to a large copper area to help cool the IC to further improve efficiency and long-term reliability.
- (5) Ensure all feedback connections are short and direct. Place the feedback resistors as close to the IC as possible.
- (6) Route high-speed switching nodes away from sensitive analog area.

SOT-23-6

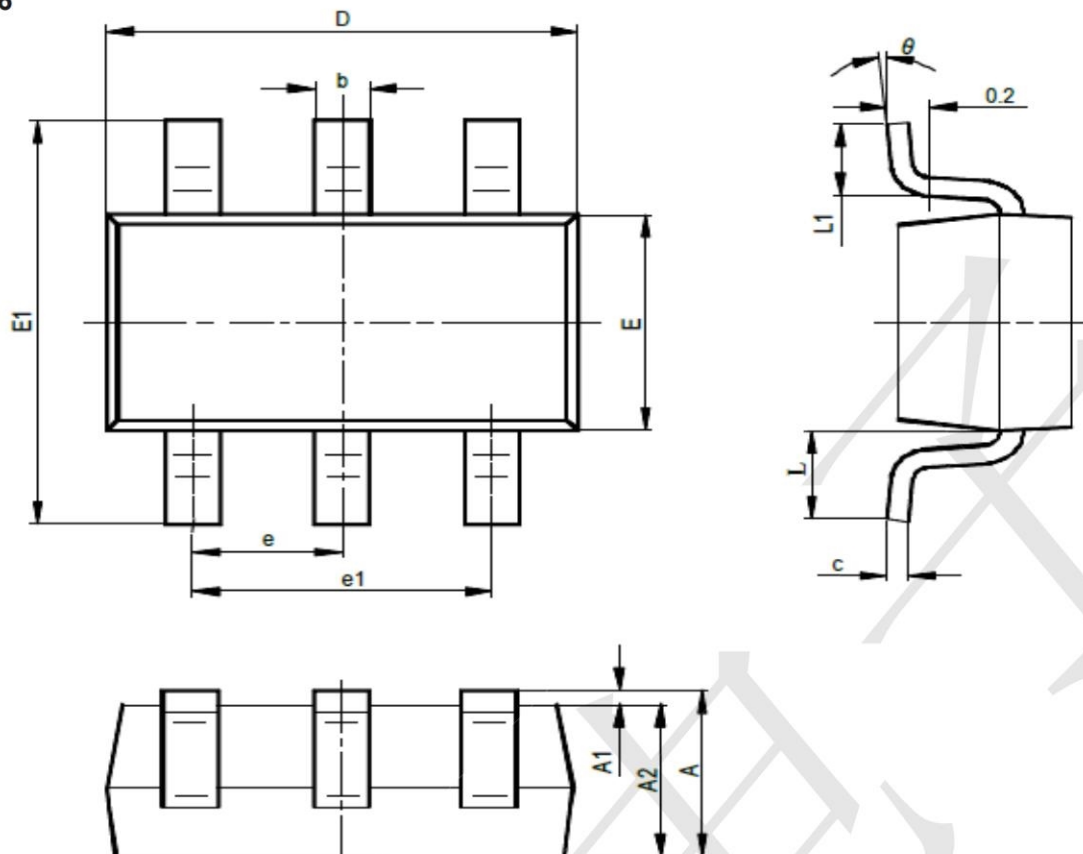

SYMBOL	MILLIMETERS		INCHES	
	MIN	MAX	MIN	MAX
A	1.050	1.250	0.041	0.049
A1	0.000	0.100	0.000	0.004
A2	1.050	1.150	0.041	0.045
b	0.300	0.400	0.012	0.016
c	0.100	0.200	0.004	0.008
D	2.820	3.020	0.111	0.119
E	1.500	1.700	0.059	0.067
E1	2.650	2.950	0.104	0.116
e	0.950TYP		0.037TYP	
e1	1.800	2.000	0.071	0.079
L	0.700REF		0.028REF	
L1	0.300	0.600	0.012	0.024
theta	0°	8°	0°	8°