USB HIGH-SIDE POWER SWITCH / LOAD SWITCH

NO.EA-188-200930

OUTLINE

The R5524x is a CMOS-based high-side MOSFET switch IC which conforms to the universal serial bus (USB) standard. It can also be used as a load switch IC with protection function. By using an Nch MOSFET with low On-resistance (Typ. 100 mΩ) as a switching transistor, the device can provide low dropout voltage. Internally, the device consists of an overcurrent limiting circuit, a thermal shutdown circuit, an undervoltage lockout (UVLO) circuit and a reverse current protection circuit. The device also consists of an internal delay circuit to prevent the output of false flag signals caused by inrush current. To achieve simplification of layout design, the overcurrent detection accuracy has been improved. The R5524x is offered in a 5-pin SOT-23-5 package and a 6-pin DFN(PLP)1820-6 package which achieve the smallest possible footprint solution on boards where area is limited.

FEATURES

- N-channel MOS High-Side Switch IC
- Switch ON Resistance..... Typ. 100 mΩ at 5 V Input
- Current Limit Threshold Min. 650 mA⁽¹⁾, Min. 1.25 A⁽²⁾
- Overcurrent Limit..... Min. 550 mA
- Flag Delay Time..... Typ. 20 ms
- Under-voltage Lockout (UVLO) Circuit
- Thermal Shutdown Circuit
- Reverse Current Protection Circuit
- Package..... SOT-23-5, DFN(PLP)1820-6⁽³⁾

APPLICATIONS

- PCs and PC Peripherals
- Digital Televisions (DTV)
- Set Top Boxes (STB)
- Printers
- PDA
- Game Consoles

⁽¹⁾ Only for R5524x001A/B, R5524x002A/B

⁽²⁾ Only for R5524N004A

⁽³⁾ Only for R5524K001x, R5524K002x

■ SELECTION GUIDE

The overcurrent limit protection type, the current limit threshold and the auto discharge options⁽¹⁾ for the ICs are user-selectable options.

Selection Guide

Product Name	Package	Quantity per Reel	Pb Free	Halogen Free
R5524N00x*-TR-FE	SOT-23-5	3,000 pcs	Yes	Yes
R5524K00x*-TR	DFN(PLP)1820-6	5,000 pcs	Yes	Yes

x: Specify the combination of Overcurrent Limit Protection type and Current Limit Threshold.

1: Latch-off Type, Current Limit Threshold: Min. 650 mA

2: Constant Current Type, Current Limit Threshold: Min. 650 mA

4: Constant Current Type, Current Limit Threshold: Min. 1.25 A⁽²⁾

*: Specify auto-discharge options.

A: Auto-discharge included

B: Auto-discharge not included

⁽¹⁾ Auto-discharge function quickly lowers the output voltage to 0 V, when the chip enable signal is switched from the active mode to the standby mode, by releasing the electrical charge accumulated in the external capacitor.

⁽²⁾ Only for R5524N004A

BLOCK DIAGRAMS

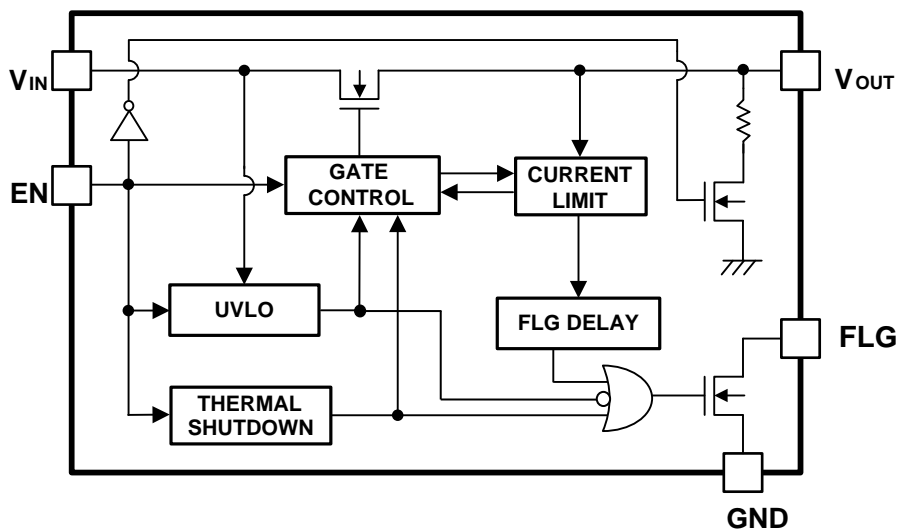

R5524xxxxA Block Diagram

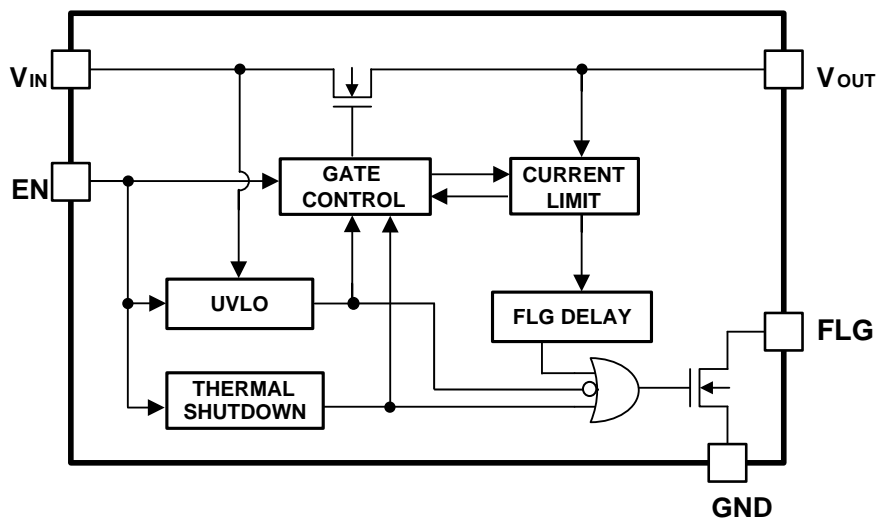

R5524xxxxB Block Diagram

PIN DESCRIPTIONS

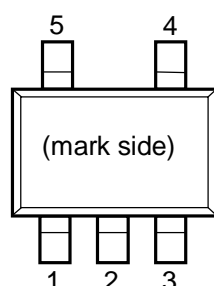

R5524N (SOT-23-5) Pin Configuration

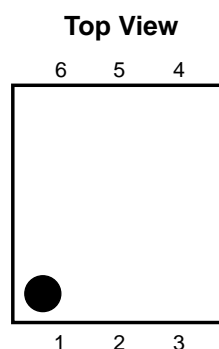

R5524K (DFN(PLP)1820-6) Pin Configuration

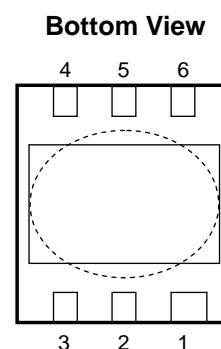

R5524N Pin Description

Pin No.	Symbol	Description
1	VIN	Input Pin
2	GND	Ground Pin
3	EN	Chip Enable Pin, Active-high
4	FLG	Flag Pin, Open Drain Output
5	VOUT	Output Pin

R5524K Pin Description

Pin No.	Symbol	Description
1	VOUT	Output Pin
2	NC	No Connection
3	FLG	Flag Pin, Open Drain Output
4	EN	Enable Pin, Active-high
5	GND	Ground Pin
6	VIN	Input Pin

The exposed tab is substrate level (GND). It is recommended that the exposed tab be connected to the ground plane on the board or otherwise be left open.

ABSOLUTE MAXIMUM RATINGS

Absolute Maximum Ratings

Symbol	Item	Rating	Unit
V _{IN}	Input Voltage	6.0	V
V _{EN}	Enable Pin Input Voltage	-0.3 to 6.0	V
V _{FLG}	Flag Pin Voltage	-0.3 to 6.0	V
I _{FLG}	Flag Pin Current	14	mA
V _{OUT}	Output Pin Voltage	-0.3 to 6.0	V
I _{OUT}	Output Current	Internally Controlled	
P _D	Power Dissipation ⁽¹⁾	SOT-23-5, JEDEC STD.51-7	660 mW
		DFN(PLP)1820-6, JEDEC STD.51-7	2200 mW
T _j	Junction Temperature Range	-40 to 125	°C
T _{stg}	Storage Temperature Range	-55 to 125	°C

ABSOLUTE MAXIMUM RATINGS

Electronic and mechanical stress momentarily exceeded absolute maximum ratings may cause permanent damage and may degrade the lifetime and safety for both device and system using the device in the field. The functional operation at or over these absolute maximum ratings is not assured.

■ RECOMMENDED OPERATING CONDITIONS

Symbol	Parameter	Rating	Unit
V _{IN}	Operating Input Voltage	2.7 to 5.5	V
T _a	Operating Temperature Range	-40 to 85	°C

RECOMMENDED OPERATING CONDITIONS

All of electronic equipment should be designed that the mounted semiconductor devices operate within the recommended operating conditions. The semiconductor devices cannot operate normally over the recommended operating conditions, even if they are used over such conditions by momentary electronic noise or surge. And the semiconductor devices may receive serious damage when they continue to operate over the recommended operating conditions.

⁽²⁾ Refer to *POWER DISSIPATION* for detailed information.

ELECTRICAL CHARACTERISTICS

The specifications surrounded by are guaranteed by design engineering at $-40^{\circ}\text{C} \leq T_a \leq 85^{\circ}\text{C}$.

R5524xxxxA/B Electrical Characteristics

($T_a = 25^{\circ}\text{C}$)

Symbol	Item	Conditions	Min.	Typ.	Max.	Unit	
V_{IN}	Input Voltage		2.7		5.5	V	
I_{DD1}	Supply Current (Active Mode)	$V_{OUT} = \text{OPEN}$, $EN = \text{"H"}$, $V_{IN} = 5\text{ V}$		110	180	μA	
I_{DD2}	Supply Current (Standby Mode)	$V_{OUT} = \text{OPEN}$, $EN = \text{"L"}$, $V_{IN} = 5\text{ V}$		0.1	1.0	μA	
R_{ON}	Switch On Resistance	$V_{IN} = 5\text{ V}$, $I_{OUT} = 500\text{ mA}$		100	150	$\text{m}\Omega$	
t_{on}	Output Turn-on Delay	$V_{IN} = 5\text{ V}$, $R_L = 60\ \Omega$		400		μs	
t_{off}	Output Turn-off Delay	$V_{IN} = 5\text{ V}$, $R_L = 60\ \Omega$		50		μs	
V_{UVLO}	UVLO Release Voltage	V_{IN} Rising	2.3	2.5	2.7	V	
V_{HYS}	UVLO Hysteresis Range	V_{IN} Falling		0.1		V	
I_{TH}	Current Limit Threshold	R5524x001A/B R5524x002A/B	$V_{IN} = 5\text{ V}$	650	800	980	mA
		R5524N004A	$V_{IN} = 5\text{ V}$	1.25	1.55	1.85	A
			$V_{IN} = 5\text{ V}$, $0^{\circ}\text{C} \leq T_a \leq 70^{\circ}\text{C}$	1.2	1.55	1.9	
I_{LIM}	Overcurrent Limit	$V_{IN} = 5\text{ V}$, After 5 ms from when $V_{OUT} = 0\text{ V}^{(1)}$	550	650	800	mA	
t_{FD}	Flag Delay Time ⁽²⁾	$V_{IN} = 5\text{ V}$, From when overcurrent detection until when $FLG = \text{"L"}$	7	20	30	ms	
T_{TSD}	Thermal Shutdown Temperature	Junction Temperature		135		$^{\circ}\text{C}$	
T_{TSR}	Thermal Shutdown Released Temperature	Junction Temperature		120		$^{\circ}\text{C}$	
I_{EN}	Enable Pin Input Current			0.01	1.0	μA	
V_{EN1}	Enable Pin Input Voltage 1	V_{EN} Rising	2.0		6.0	V	
V_{EN2}	Enable Pin Input Voltage 2	V_{EN} Falling	-0.3		0.8	V	
I_{LO}	Output Leakage Current			0.1	1.0	μA	
V_{LF}	Flag "L" Output Voltage	$I_{SINK} = 1\text{ mA}$			0.4	V	
I_{FOF}	Flag Off Current	$V_{FLG} = 5.5\text{ V}$		0.01	1.0	μA	
I_{REV}	Reverse Leakage Current	$V_{IN} = 0\text{ V}$, $V_{OUT} = 5.5\text{ V}$			50	μA	
R_{LOW}	Nch. On-resistance for Auto Discharge (R5524x00xA only)			450		Ω	

All test items listed under Electrical Characteristics are done under the pulse load condition ($T_j \approx T_a = 25^{\circ}\text{C}$) except Thermal Shutdown Temperature and Thermal Shutdown Released Temperature.

⁽¹⁾ Refer to "Overcurrent limit Function" in THEORY OF OPERATION for details.

⁽²⁾ Flag Delay Time is dependent on Input Voltage.

THEORY OF OPERATION

Overcurrent Limit Function

The R5524x001A/001B has the built-in latch-off type over-current limit circuit. When the over-current is detected, the protection circuit becomes active and the switch-transistor is turned OFF. The latch function is released if the input voltage value is exceeded in the release threshold of the UVLO circuit value after when it became lower than the detection threshold of the UVLO circuit value; or the EN pin set to the enabling condition again after set to the disabling condition.

If the over current condition occurred when the input voltage value was close to the minimum operating input voltage value. Under this condition, the voltage descends by the parasitic impedance on the power supply side, and it might fall below the detection threshold of the UVLO circuit. In this case, the switch-transistor is turned OFF and because of that the voltage drop of power line's parasitic impedance stops; the latch function is released with the UVLO and it becomes the over current condition again. The switch transistor keeps continual ON and OFF until one of the following is done; increasing the input voltage value; the setting of EN pin is disabling; or reducing the value of load current.

Moreover, the supply-voltage changed by the load-current dramatically changed depends upon the parasitic impedance of the wiring on the load side or the power supply side. Due to this, decreasing the parasitic impedance by the wiring on board is recommended.

The switch transistor of the R5524x001A/001B is turned OFF when the latch-off-function operates under the condition of the load of the constant current as the load device, such as the electronic load and so on, connecting with the V_{OUT} pin of the R5524x001A/001B. Because the load device keeps the constant current, the V_{OUT} pin voltage may become negative potential. If the V_{OUT} pin is exceed the absolute maximum rating may cause the permanent damages to the device, please avoid using in this situation.

The R5524x002A/002B and R5524N004A have the built-in over current protection circuit as the constant current type. It detects as the over-current condition, if the current flows as the I_{TH} defined. Then operating the switch transistor to limit the output current to be the constant current defined by the I_{LIM} .

If the condition of the over-current limit caused by the V_{OUT} pin clamped to the GND were continued the temperature of the ICs would increase drastically. The switch-transistor is turned OFF if the temperature of the ICs becomes over 135°C (Typ.). And after this, the switch-transistor is turned ON again when the temperature of ICs decreased approximately 15°C. The switch-transistor keeps continual ON and OFF until either the switch is turned OFF or the V_{OUT} pin is removed from GND.

Timing Chart

R5524xxxxA/B

Output On-time and Output Off-time

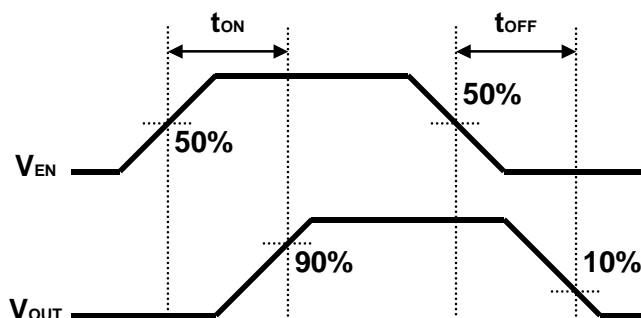

R5524x Timing Chart

R5524x001A/B (Latch-off Type)

Flag Delay Time

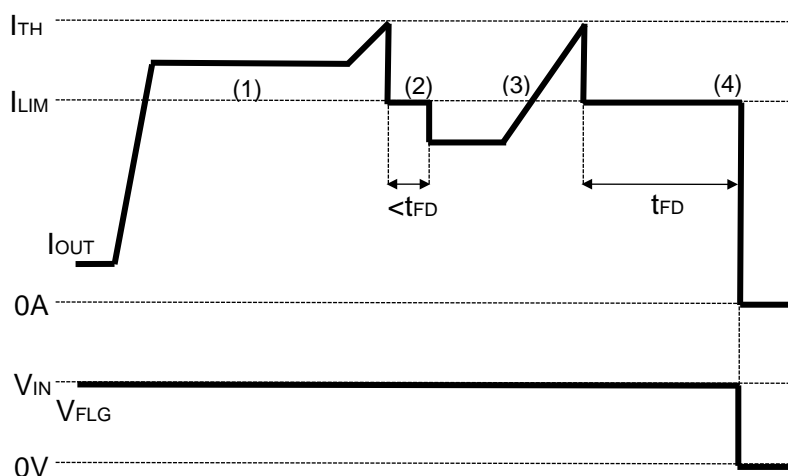

R5524x001A/001B (Latch-off Type) Timing Chart

- (1) When the I_{OUT} is I_{TH} or less, the current is not limited.
- (2) Once the I_{OUT} reaches to I_{TH} , the I_{OUT} is limited by I_{LIM} .
- (3) When the I_{OUT} drops to I_{LIM} or less within the t_{FD} time, the current limit is released. The current is not limited until the I_{OUT} exceeds I_{TH} again.
- (4) When the I_{OUT} reaches to I_{TH} and it is limited by I_{LIM} for t_{FD} or more, the switch transistor turns off and V_{FLG} becomes "Low".

R5524x002A/B, R5524N0004A (Constant Current Protection Type)

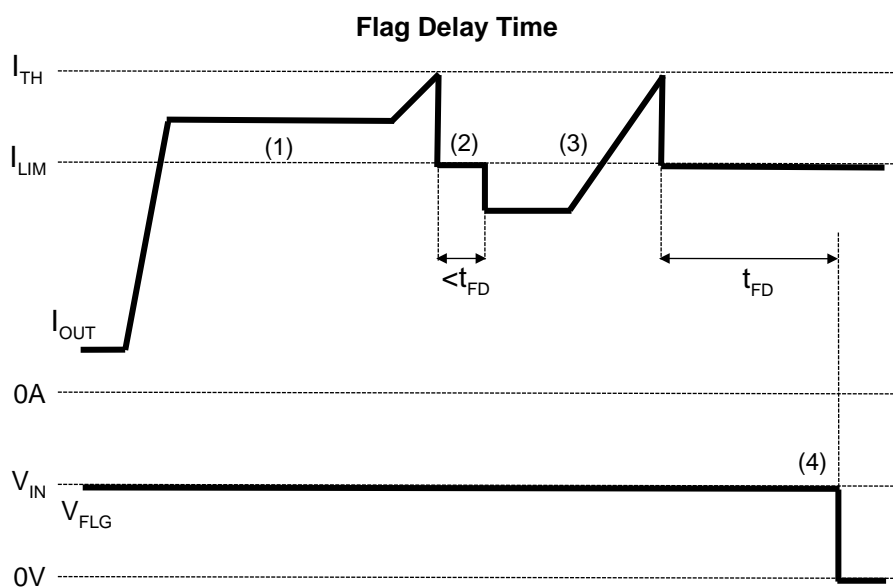

R5524x002A/002B and R5524N004A (Constant Current Type) Timing Chart

- (1) When I_{OUT} is I_{TH} or less, the current is not limited.
- (2) Once the I_{OUT} reaches to I_{TH} , the I_{OUT} is limited by I_{LIM} .
- (3) When the I_{OUT} drops to I_{LIM} or less within the t_{FD} time, the current limit is released. The current is not limited until the I_{OUT} exceeds I_{TH} again.
- (4) When the I_{OUT} reaches to I_{TH} and it is limited by I_{LIM} for t_{FD} or more, the V_{FLG} becomes "Low".

APPLICATION INFORMATION

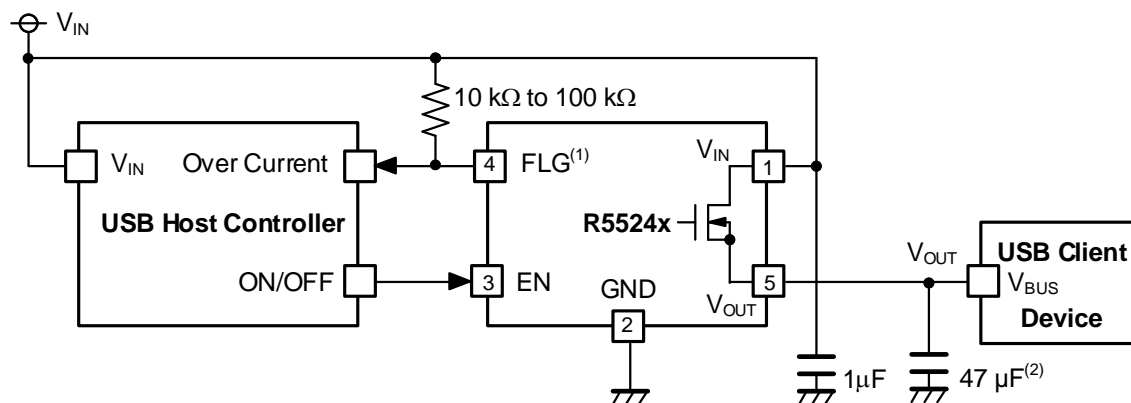

R5524x Typical Reference Circuit

Precautions for Selecting External Components

Bypass Capacitor

A 0.1 μF to 1 μF bypass capacitor between the V_{IN} pin and the GND pin, close to the device, is recommended. This precaution reduces power supply transients that may cause ringing on the input.

Pull-up Resistor of FLG Pin

A 10 kΩ to 100 kΩ pull-up resistor is recommended for the FLG pin.

R5524x001A/001B

The R5524x001A/001B is equipped with a latch-off function which requires initialization before start-up.

Case 1: Start-up by EN Pin Control

EN pin must be enabled with the delay of 10 μs or more against 90% of V_{IN} voltage rising edge.

Case 2: Start-up by EN Pin Tied to V_{IN} Pin

Slew rate of V_{IN} must be 40 μs/V or slower.

⁽¹⁾ FLG pin is Nch. Open Drain Output.

⁽²⁾ A 47 μF or more output capacitor is recommended. According to a USB standard, a 120 μF or more output capacitor is required.

TYPICAL CHARACTERISTICS

Note: Typical Characteristics are intended to be used as reference data; they are not guaranteed.

1) Supply Current vs. Temperature

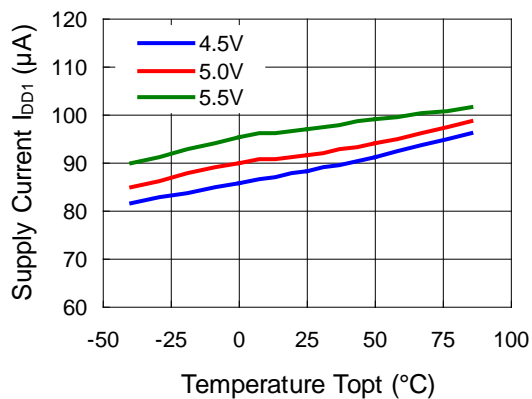

2) Supply Current vs. Input Voltage

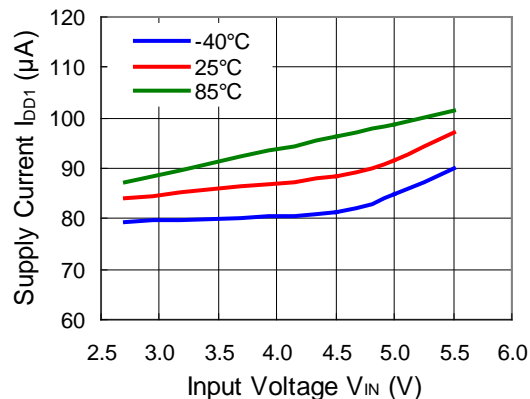

3) Switch ON Resistance vs. Temperature

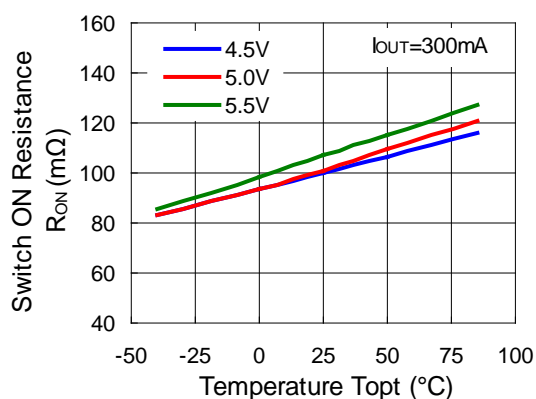

4) Switch ON Resistance vs. Input Voltage

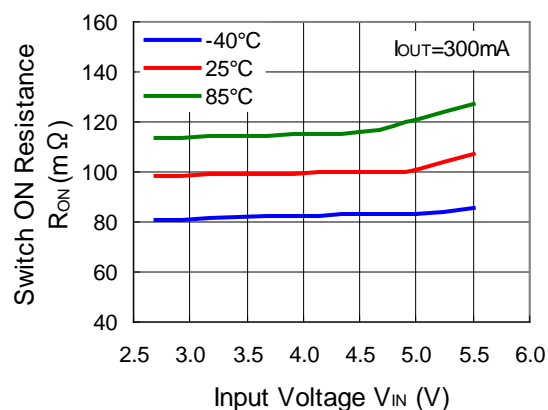

5) Output ON Time vs. Temperature ($R_L = 56 \Omega$)

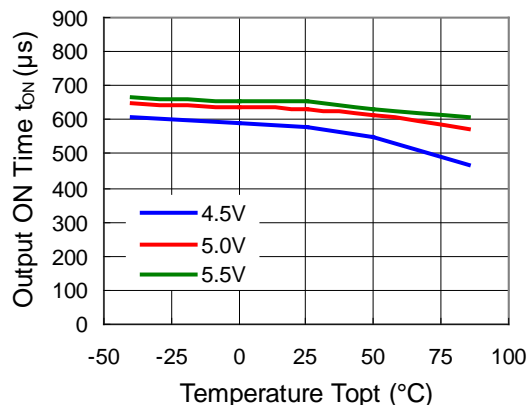

6) Output ON Time vs. Input Voltage ($R_L = 56 \Omega$)

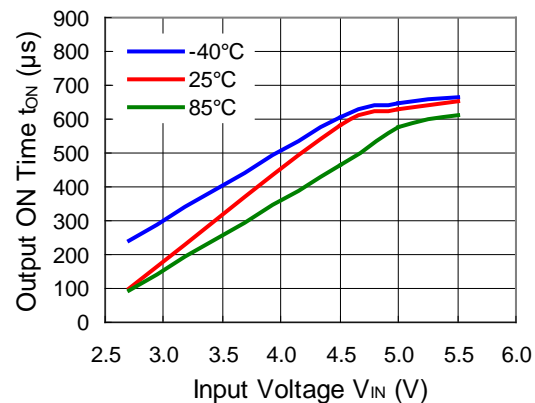

7) UVLO Voltage vs. Temperature

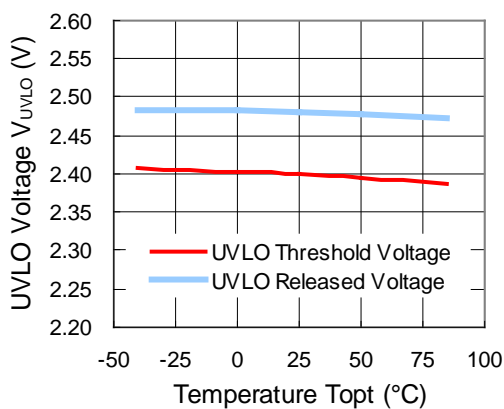

8) Output Voltage vs. Input Voltage

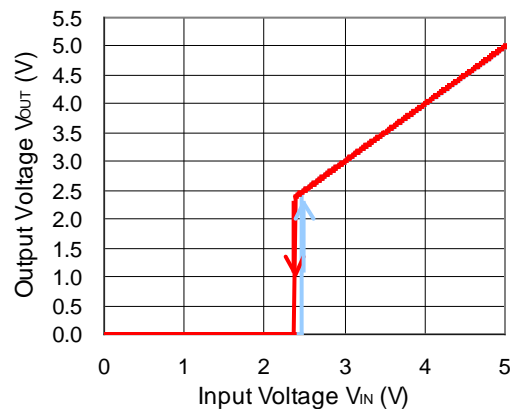

9) Current Limit Threshold vs. Temperature (001x/ 002x)

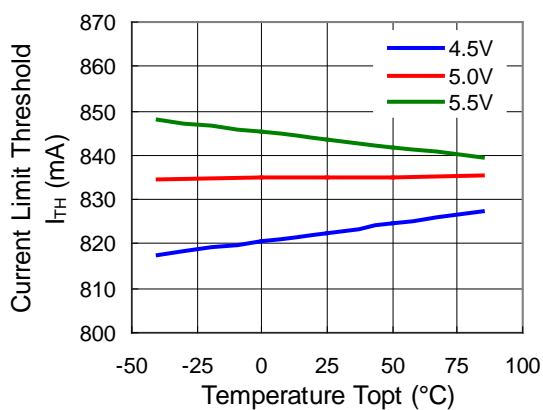

10) Current Limit Threshold vs. Temperature (004A)

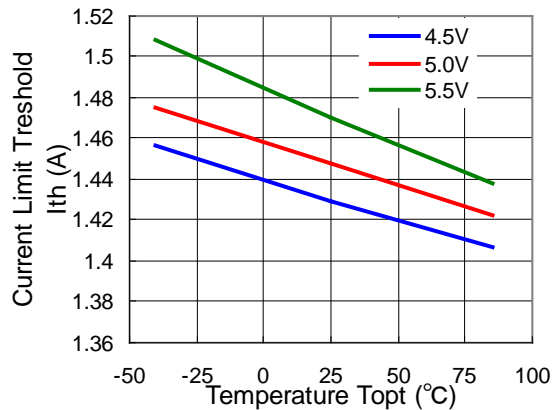

11) Current Limit Threshold vs. Input Voltage (001x/ 002x)

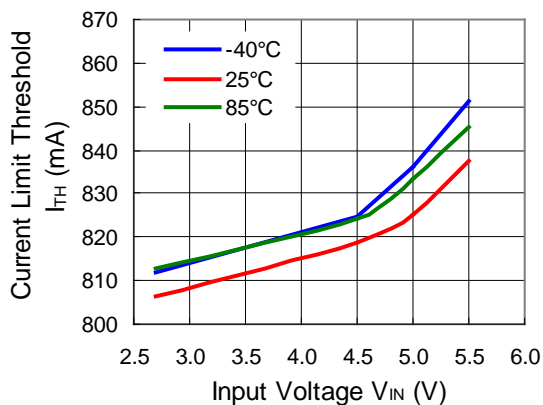

12) Current Limit Threshold vs. Input Voltage (004A)

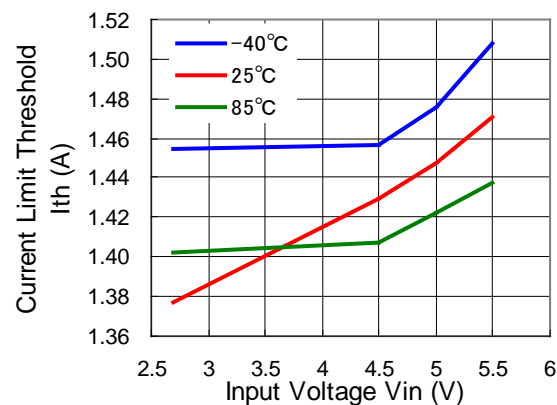

13) Overcurrent Limit vs. Temperature

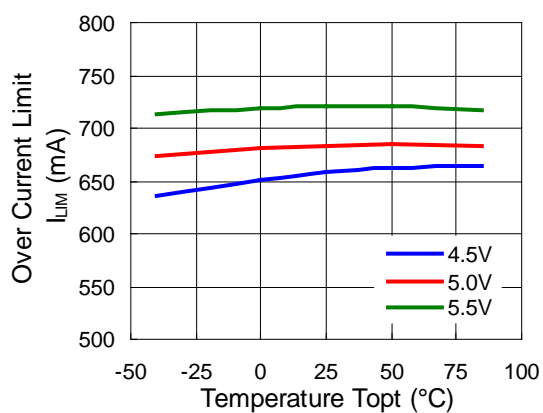

14) Overcurrent Limit vs. Input Voltage

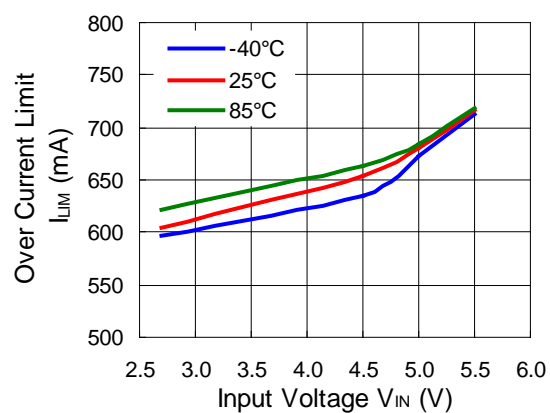

15) Flag Delay Time vs. Temperature

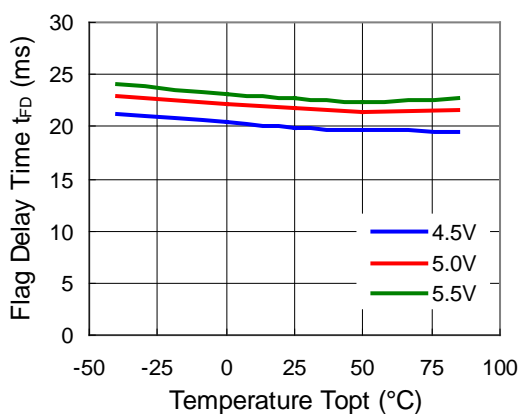

16) Flag Delay Time vs. Input Voltage

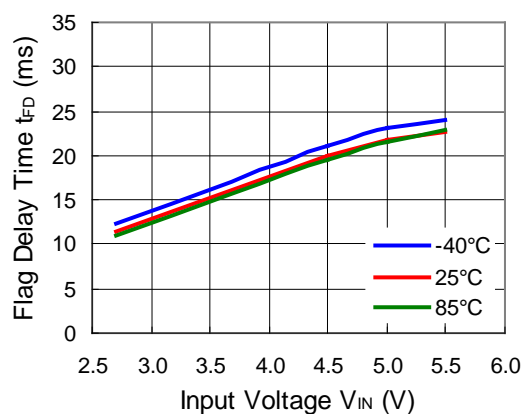

17) Enable Input Voltage vs. Temperature

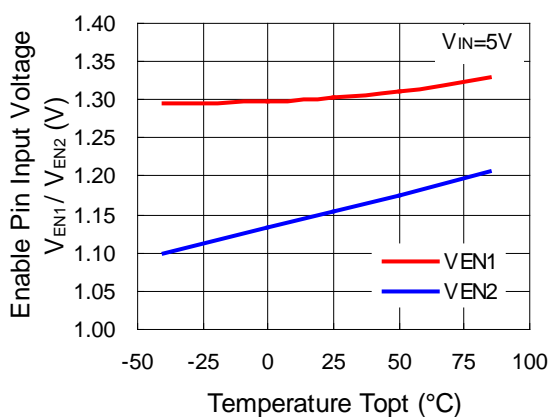

18) Enable Input Voltage vs. Input Voltage

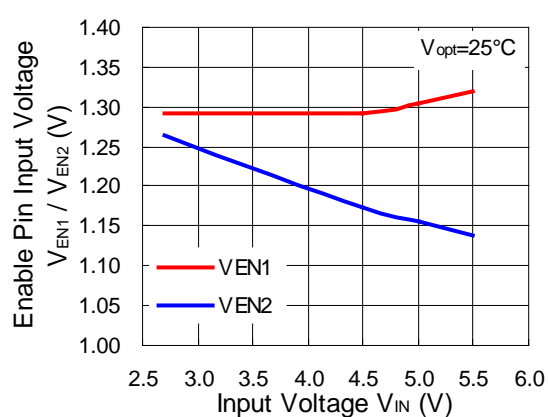

19) Overcurrent Response with Ramped Load 20) Overcurrent Response with Ramped Load

(R5524x001x)

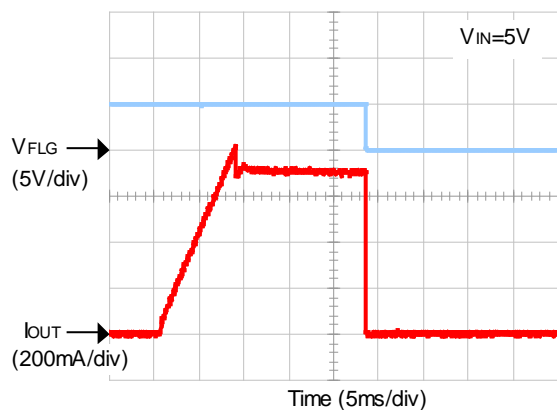

(R5524x002x)

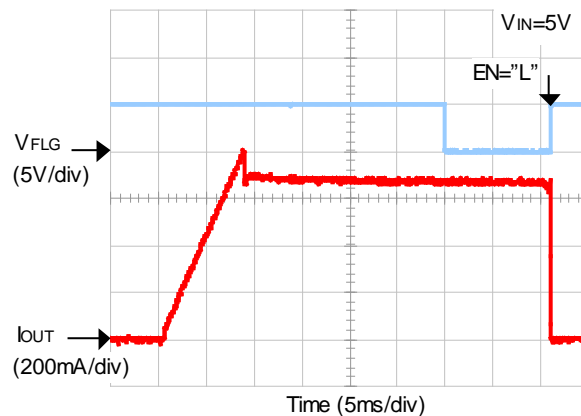

21) Overcurrent Response with Ramped Load (R5524x004A)

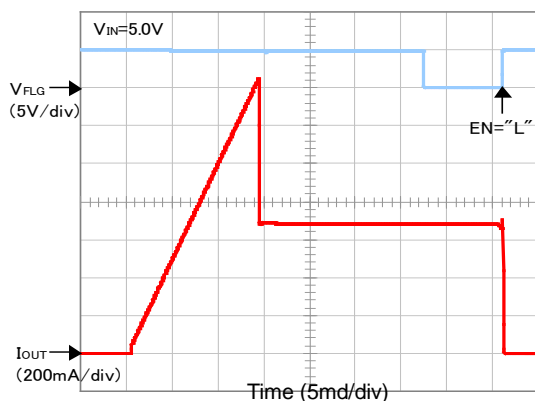

22) Overcurrent Limit Transient Response (Output short during enable "H")

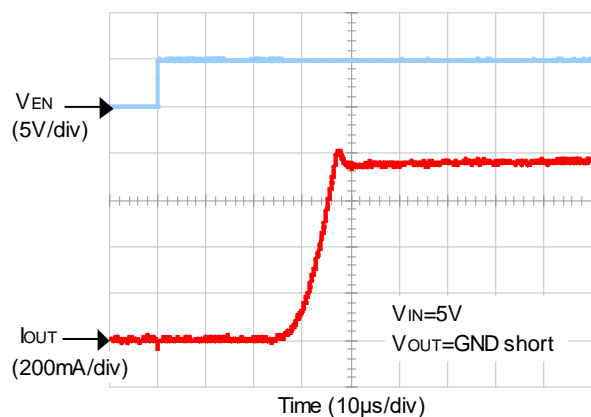

(Enable "H" during Output Short)

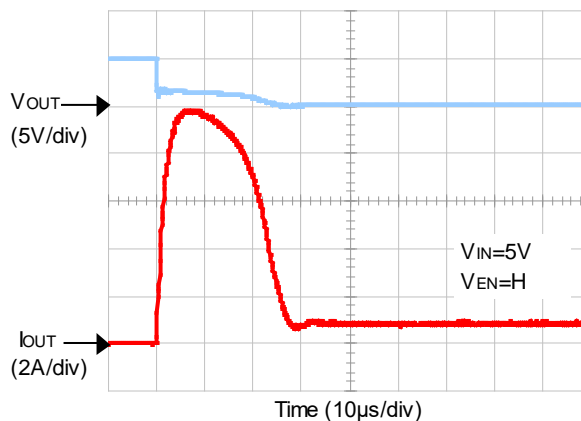

23) Thermal Shutdown Operation

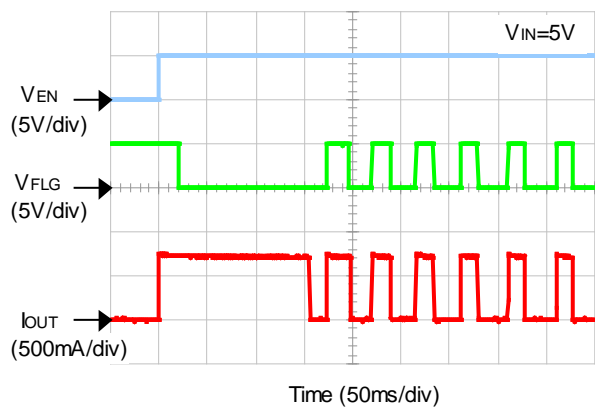

24) Output Voltage vs. Output Current

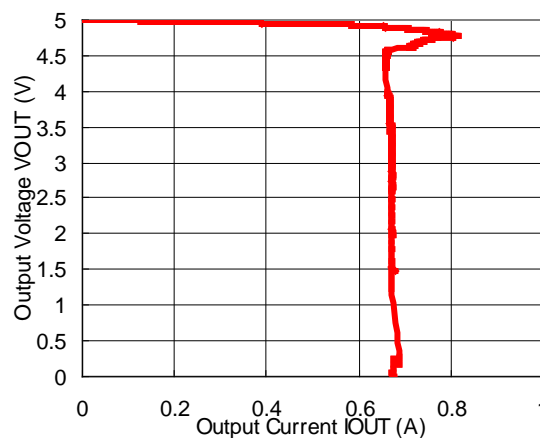

25) Output ON Time Response

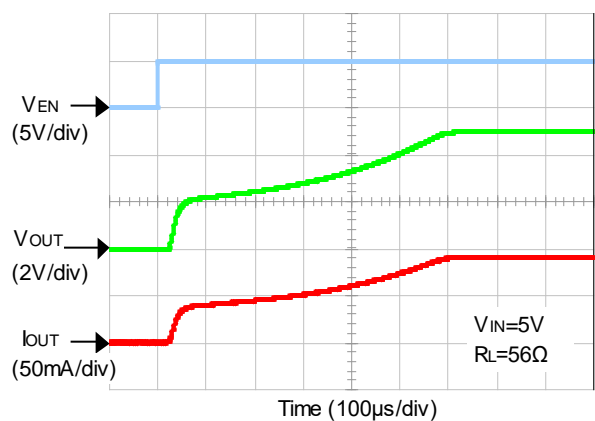

26) Output OFF Time Response

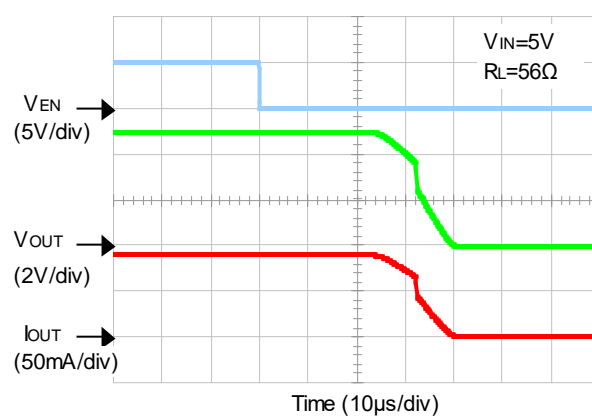

27) Inrush current Characteristic

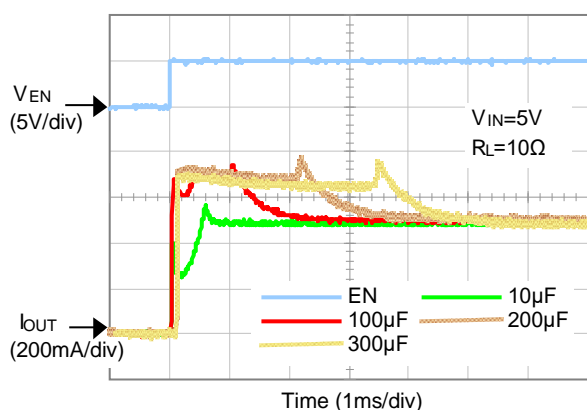

The power dissipation of the package is dependent on PCB material, layout, and environmental conditions. The following measurement conditions are based on JEDEC STD. 51-7.

Measurement Conditions

Item	Measurement Conditions
Environment	Mounting on Board (Wind Velocity = 0 m/s)
Board Material	Glass Cloth Epoxy Plastic (Four-Layer Board)
Board Dimensions	76.2 mm × 114.3 mm × 0.8 mm
Copper Ratio	Outer Layer (First Layer): Less than 95% of 50 mm Square Inner Layers (Second and Third Layers): Approx. 100% of 50 mm Square Outer Layer (Fourth Layer): Approx. 100% of 50 mm Square
Through-holes	φ 0.3 mm × 7 pcs

Measurement Result

(Ta = 25°C, Tjmax = 125°C)

Item	Measurement Result
Power Dissipation	660 mW
Thermal Resistance (θja)	θja = 150°C/W
Thermal Characterization Parameter (ψjt)	ψjt = 51°C/W

θja: Junction-to-Ambient Thermal Resistance

ψjt: Junction-to-Top Thermal Characterization Parameter

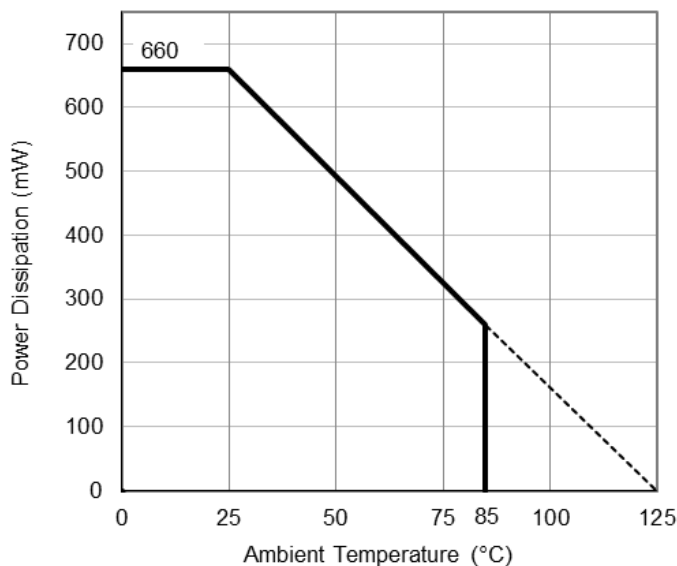

Power Dissipation vs. Ambient Temperature

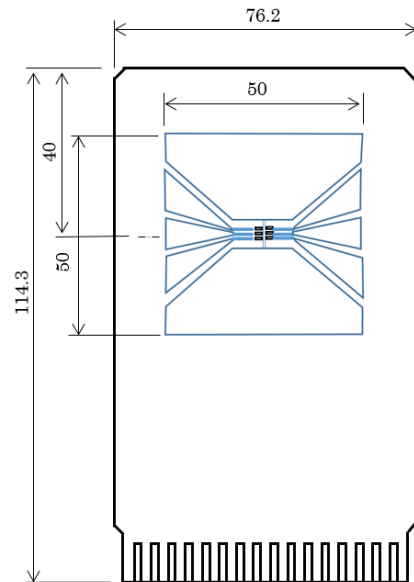

Measurement Board Pattern

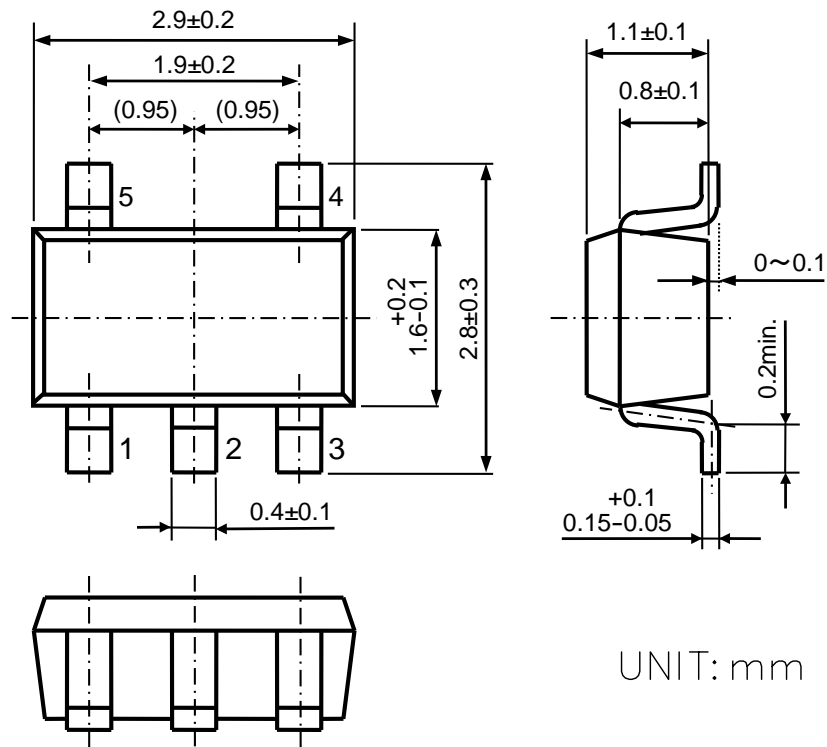

UNIT: mm

SOT-23-5 Package Dimensions

The power dissipation of the package is dependent on PCB material, layout, and environmental conditions. The following measurement conditions are based on JEDEC STD. 51-7.

Measurement Conditions

Item	Measurement Conditions
Environment	Mounting on Board (Wind Velocity = 0 m/s)
Board Material	Glass Cloth Epoxy Plastic (Four-Layer Board)
Board Dimensions	76.2 mm × 114.3 mm × 0.8 mm
Copper Ratio	Outer Layer (First Layer): Less than 95% of 50 mm Square Inner Layers (Second and Third Layers): Approx. 100% of 50 mm Square Outer Layer (Fourth Layer): Approx. 100% of 50 mm Square
Through-holes	φ 0.2 mm × 34 pcs

Measurement Result

(Ta = 25°C, Tjmax = 125°C)

Item	Measurement Result
Power Dissipation	2200 mW
Thermal Resistance (θja)	θja = 45°C/W
Thermal Characterization Parameter (ψjt)	ψjt = 18°C/W

θja: Junction-to-Ambient Thermal Resistance

ψjt: Junction-to-Top Thermal Characterization Parameter

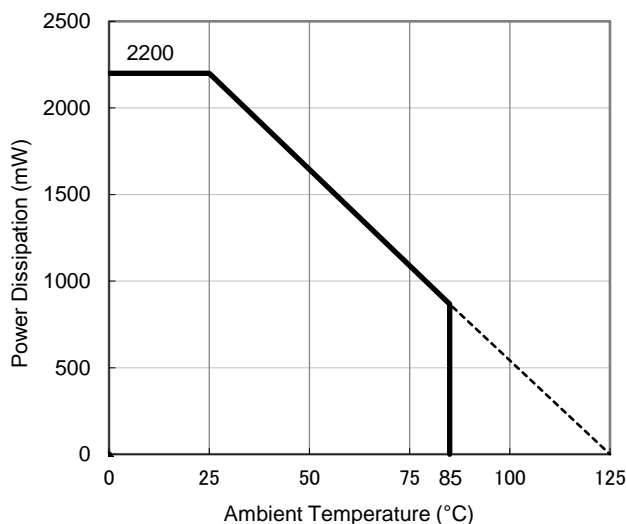

Power Dissipation vs. Ambient Temperature

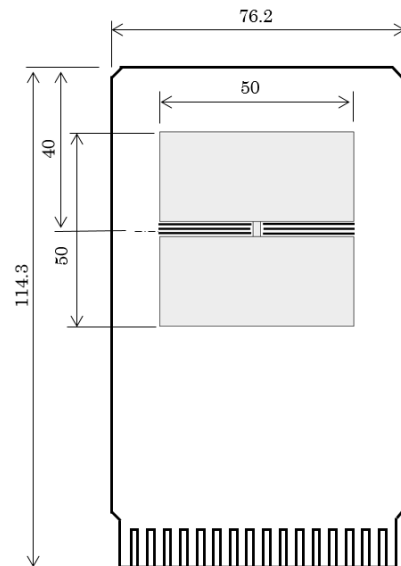

Measurement Board Pattern

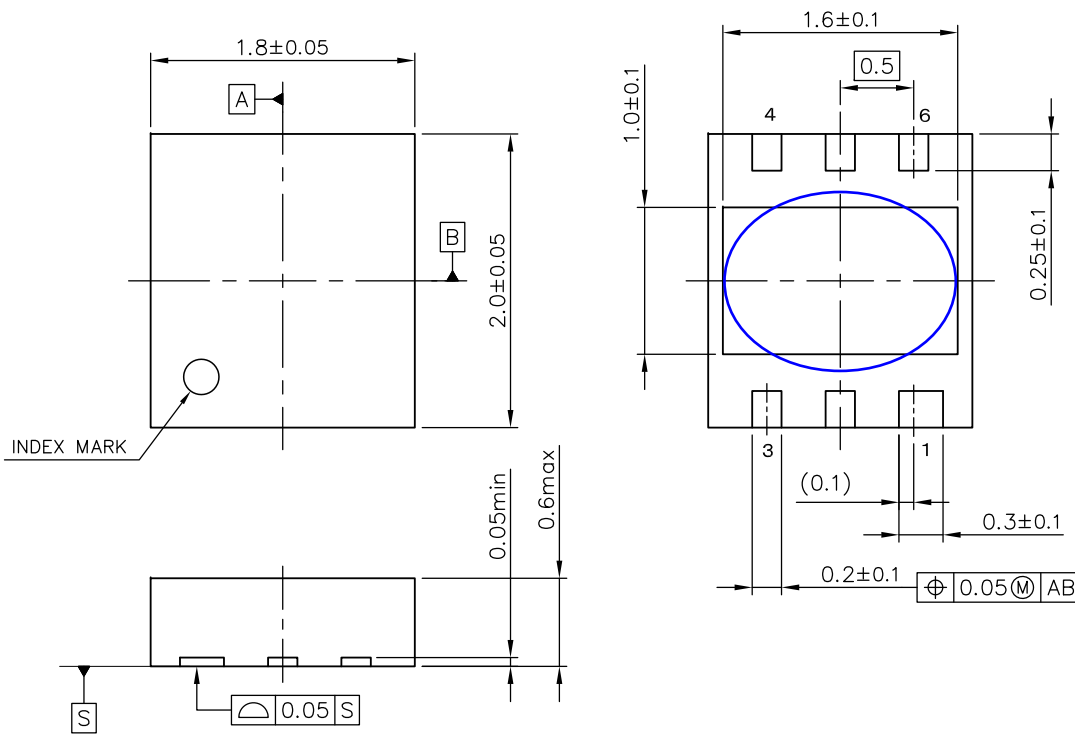

UNIT: mm

DFN(PLP)1820-6 Package Dimensions

* The tab on the bottom of the package is substrate level (GND). It is recommended that the tab be connected to the ground plane on the board, or otherwise be left floating.



1. The products and the product specifications described in this document are subject to change or discontinuation of production without notice for reasons such as improvement. Therefore, before deciding to use the products, please refer to Ricoh sales representatives for the latest information thereon.
2. The materials in this document may not be copied or otherwise reproduced in whole or in part without prior written consent of Ricoh.
3. Please be sure to take any necessary formalities under relevant laws or regulations before exporting or otherwise taking out of your country the products or the technical information described herein.
4. The technical information described in this document shows typical characteristics of and example application circuits for the products. The release of such information is not to be construed as a warranty of or a grant of license under Ricoh's or any third party's intellectual property rights or any other rights.
5. The products listed in this document are intended and designed for use as general electronic components in standard applications (office equipment, telecommunication equipment, measuring instruments, consumer electronic products, amusement equipment etc.). Those customers intending to use a product in an application requiring extreme quality and reliability, for example, in a highly specific application where the failure or misoperation of the product could result in human injury or death (aircraft, spacevehicle, nuclear reactor control system, traffic control system, automotive and transportation equipment, combustion equipment, safety devices, life support system etc.) should first contact us.
6. We are making our continuous effort to improve the quality and reliability of our products, but semiconductor products are likely to fail with certain probability. In order to prevent any injury to persons or damages to property resulting from such failure, customers should be careful enough to incorporate safety measures in their design, such as redundancy feature, fire containment feature and fail-safe feature. We do not assume any liability or responsibility for any loss or damage arising from misuse or inappropriate use of the products.
7. Anti-radiation design is not implemented in the products described in this document.
8. The X-ray exposure can influence functions and characteristics of the products. Confirm the product functions and characteristics in the evaluation stage.
9. WLCSP products should be used in light shielded environments. The light exposure can influence functions and characteristics of the products under operation or storage.
10. There can be variation in the marking when different AOI (Automated Optical Inspection) equipment is used. In the case of recognizing the marking characteristic with AOI, please contact Ricoh sales or our distributor before attempting to use AOI.
11. Please contact Ricoh sales representatives should you have any questions or comments concerning the products or the technical information.



Ricoh is committed to reducing the environmental loading materials in electrical devices with a view to contributing to the protection of human health and the environment.

Ricoh has been providing RoHS compliant products since April 1, 2006 and Halogen-free products since April 1, 2012.

RICOH RICOH ELECTRONIC DEVICES CO., LTD.

Official website

<https://www.n-redc.co.jp/en/>

Contact us

<https://www.n-redc.co.jp/en/buy/>

