

LEFT SIDE VIEW

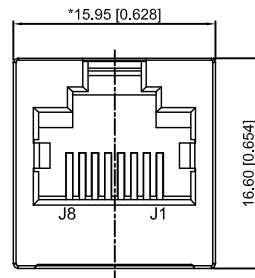

FRONT VIEW

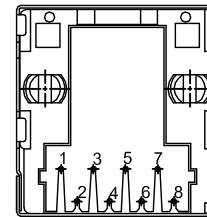

BACK VIEW

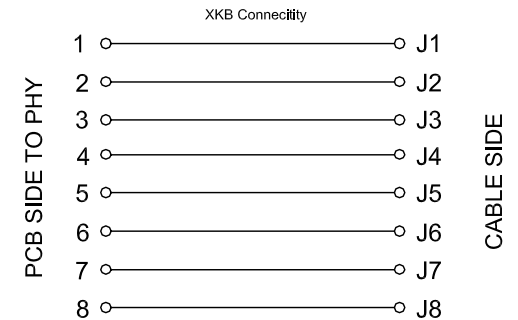

CABLE SIDE

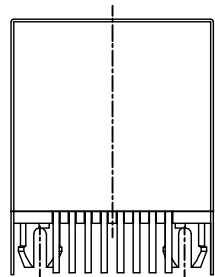

BOTTOM VIEW

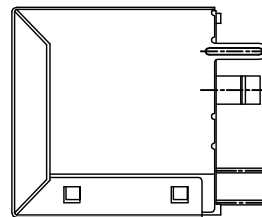

RIGHT SIDE VIEW

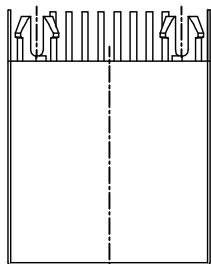

TOP VIEW

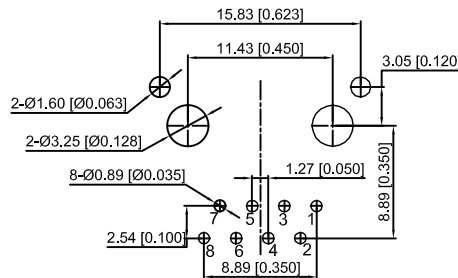

RECOMMENDED PCB LAYOUT  
VIEWED FROM COMPONENT SIDE

XKB Connectivity

XKB Connectivity

**MATERIAL 材料:**

HOUSING 外壳: PBT,UL94V-0,BLACK.

TERMINAL 端子: PHOSPHOR BRONZE ,Ø=0.46MM,  
GOLD PLATING ON CONTACT AREA.

SHIELD 保护物:C2680,T=0.20MM,20 MIN NICKEL PLATING  
ON ALL AREA.

**MECHANICAL 机械:**

DURABILITY 耐用性: 750 CYCLES MIN.12.5MM/MINUTE

INSERTION FORCE 插入力: 2.2KG.F MAX

RETENTION STRENGTH 固位力:7.7KG.F BETWEEN JACK AND PLUG

OPERATING TEMPERATURE 工作温度: -40°C~+85°C.

STORAGE TEMPERATURE 储存温度: -40°C~+85°C.

ALL CRITICAL DIMENSIONS WITH "\*"

**ELECTRICAL 电动:**

VOLTAGE 电压:125 VOL TS AC

CURRENT RATING 额定电流:1.5AMP

DIELECTRIC STRENGTH 介电强度:1000 VAC RMS 50HZ OR 60HZ,1MIN

INSULATION RESISTANCE 绝缘电阻:500 MEGA OHMS MIN.INITIAL  
AFTER 500V DC FOR 1 MINUTE

CONTACT RESISTANCE 接触电阻:SINGLE TERMINAL 30 MILLIOHMS MAX  
INITIAL 50 MILLIOHMS MAX.AFTER  
DURABILITY TEST

					DSND		DATE		SCALE: N/A	MODEL TYPE: RJ JACK		
					DWN		DATE		VIEW:	PART NO.:		
					CHKD		DATE		UNIT: mm/in	DWG NO.:		
					APPD		DATE		SIZE: A4	X05ADGWA3DY1027		
REVISIONS					UNSPECIFIED TOLERANCES					WEIGHT	SHEET	REVISION
www.xk-dg.cn www.helloxkb.com www.helloxkb.cn					XKB INDUSTRIAL PRECISION CO.,LIMITED					1.0g	1/1	A0

MARK	DESCRIPTION	DATE	REVISED	APPROVED
ΔX				
ΔX				
ΔX				

ANGLAR	±5°
L ≤ 4	±0.2
4 < L ≤ 16	±0.3
16 < L ≤ 63	±0.4
L > 63	±0.5