

### Features

- Input Voltage Range : 1.4V to 5.5V
- 15  $\mu$ A Ground Current ( $I_Q$ ) at no Load
- PSRR = 70dB at 1kHz
- $\pm 1.5\%$  Output Accuracy
- Low (0.1 $\mu$ A) Shutdown Current
- Dropout Voltage : 0.15V at 300mA when  $V_{OUT} \geq 3V$
- Support Fixed Output Voltage 0.8V, 1.0V, 1.05V, 1.1V, 1.2V, 1.25V, 1.3V, 1.5V, 1.8V, 1.85V, 2V, 2.5V, 2.8V, 2.85V, 3V, 3.1V, 3.3V, 3.45V
- Current Limit Protection
- Over Temperature Protection
- Output Active Discharge Function
- DFN-4L 1x1 Packages

### Applications

- CDM/GSM mobile phone
- PDAs /MP3
- Audio/Video equipment

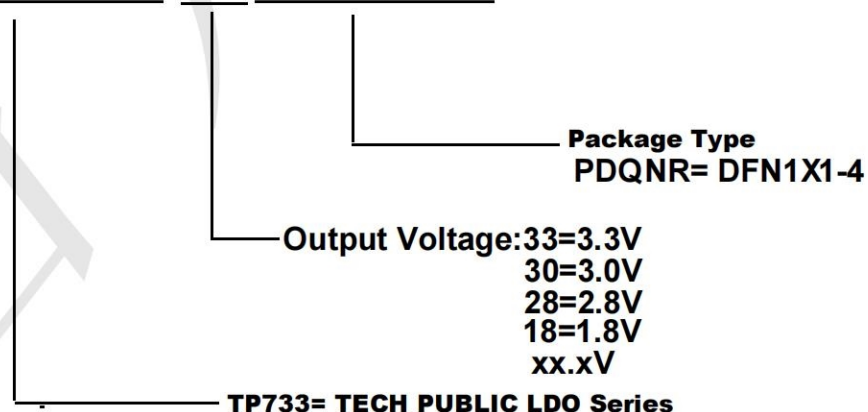
### General Description

The is a low-dropout (LDO) voltage regulator with enable function that operates from a 1.4V to 5.5V supply. It provides up to 300mA of output current in miniaturized packaging.

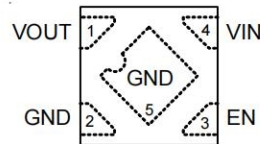
The feature of 15  $\mu$ A low quiescent current and 0.5 $\mu$ A shutdown current are ideal for the battery application with long service life. The other features include current limit function, over temperature protection and output discharge function.

### Ordering Information

## TP73318PDQNR

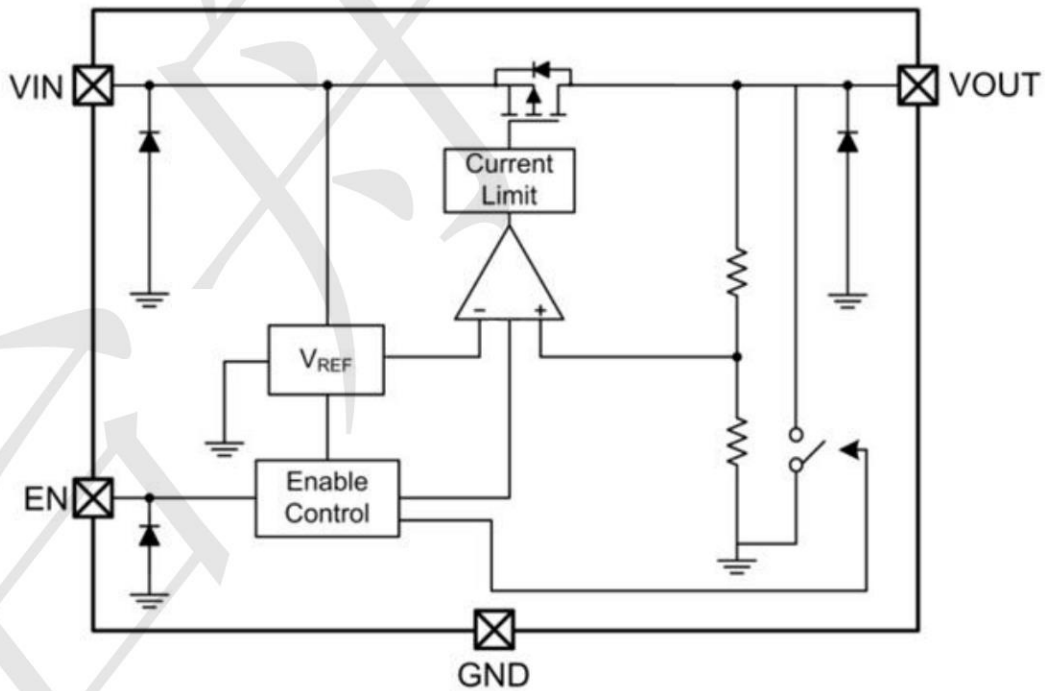


## Pin Configuration



PIN	Symbol	Description
1	VOUT	Output
2	GND	Ground
3	EN	Enable (Active high, not floating)
4	VIN	Input

## BLOCK DIAGRAM



**Absolute Maximum Rating** ( $T_A=25^{\circ}\text{C}$  unless otherwise noted)

- $V_{IN}$ ,  $V_{OUT}$ ,  $\text{EN}$  to GND ----- -0.3V to 6.5V
- $V_{OUT}$  to  $V_{IN}$  ----- -6.5V to 0.3V
- DFN-4L 1x1 ----- 0.44W
- Package Thermal Resistance (Note 2)
- DFN-4L 1x1  $\theta_{JA}$  -----  $226^{\circ}\text{C/W}$
- DFN-4L 1x1  $\theta_{JC}$  -----  $43^{\circ}\text{C/W}$
- Lead Temperature (Soldering, 10 sec.) -----  $260^{\circ}\text{C}$
- Junction Temperature -----  $150^{\circ}\text{C}$
- Storage Temperature Range -----  $-65^{\circ}\text{C}$  to  $150^{\circ}\text{C}$
- ESD Susceptibility (Note 3)
- HBM (Human Body Model) ----- 2kV

**Recommended Operating Conditions** (Note 4)

- Input Voltage,  $V_{IN}$  ----- 1.4V to 5.5V
- Junction Temperature Range -----  $-40^{\circ}\text{C}$  to  $125^{\circ}\text{C}$

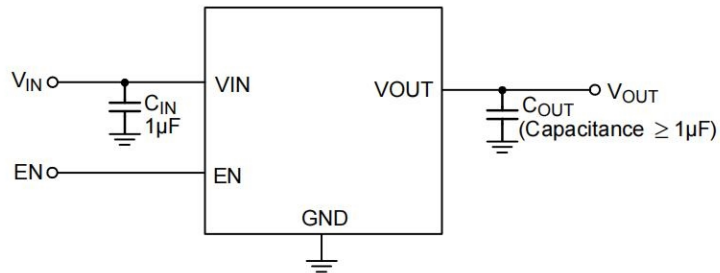
**Electrical Characteristics** ( $T = 25^{\circ}\text{C}$  unless otherwise noted)

( $V_{OUT} + 1 < V_{IN} < 5.5\text{V}$ ,  $T_A = 25^{\circ}\text{C}$ , unless otherwise specified)

Parameter	Symbol	Test Conditions	Min	Typ	Max	Unit
Fixed Output Voltage Range	$V_{OUT}$		0.8	--	3.45	V
DC Output Accuracy		$I_{LOAD} = 1\text{mA}$	-2	--	2	%
Dropout Voltage ( $I_{LOAD} = 300\text{mA}$ ) (Note 5)	$V_{DROP}$	$0.8\text{V} \leq V_{OUT} < 1.05\text{V}$	--	0.7	0.97	V
		$1.05\text{V} \leq V_{OUT} < 1.2\text{V}$	--	0.5	0.92	
		$1.2\text{V} \leq V_{OUT} < 1.5\text{V}$	--	0.4	0.57	
		$1.5\text{V} \leq V_{OUT} < 1.8\text{V}$	--	0.3	0.47	
		$1.8\text{V} \leq V_{OUT} < 2.1\text{V}$	--	0.24	0.33	
		$2.1\text{V} \leq V_{OUT} < 2.5\text{V}$	--	0.21	0.3	
		$2.5\text{V} \leq V_{OUT} < 2.8\text{V}$	--	0.18	0.25	
		$2.8\text{V} \leq V_{OUT} < 3\text{V}$	--	0.16	0.23	
Dropout Voltage ( $I_{LOAD} = 200\text{mA}$ ) (Note 6)	$V_{DROP}$	$1.8\text{V} \leq V_{OUT} < 2.1\text{V}$	--	0.16	0.2	V
$V_{CC}$ Consumption Current	$I_Q$	$I_{LOAD} = 0\text{mA}$ , $V_{OUT} \leq 5.5\text{V}$ $V_{IN} \geq V_{OUT} + V_{DROP}$	--	15	18	$\mu\text{A}$

Parameter	Symbol	Test Conditions	Min	Typ	Max	Unit	
Shutdown GND Current (Note 7)		$V_{EN} = 0V$	--	0.1	0.5	$\mu A$	
Shutdown Leakage Current (Note 7)		$V_{EN} = 0V, V_{OUT} = 0V$	--	0.1	0.5	$\mu A$	
EN Input Current	$I_{EN}$	$V_{EN} = 5.5V$	--	--	0.1	$\mu A$	
Line Regulation	$\Delta LINE$	$I_{LOAD} = 1mA$	$1.2V \leq V_{IN} < 1.5V$	--	0.3	0.6	%
			$1.5V \leq V_{IN} < 1.8V$	--	0.15	0.3	
			$1.8V \leq V_{IN} \leq 5.5V$	--	0.13	0.35	
Load Regulation	$\Delta LOAD$	$1mA < I_{LOAD} < 300mA$	--	0.5	1	%	
Power Supply Rejection Ratio	PSRR	$V_{IN} = 3V, I_{LOAD} = 50mA,$ $C_{OUT} = 1\mu F, V_{OUT} = 2.5V, f = 1kHz$	--	70	--	dB	
Output Voltage Noise		$C_{OUT} = 1\mu F,$ $I_{LOAD} = 150mA,$ $BW = 10Hz \text{ to } 100kHz,$ $V_{IN} = V_{OUT} + 1V$	$V_{OUT} = 0.8V$	--	38	--	$\mu V_{RMS}$
			$V_{OUT} = 1.2V$	--	46	--	
			$V_{OUT} = 1.8V$	--	48	--	
			$V_{OUT} = 3.3V$	--	51	--	
Output Current Limit	$I_{LIM}$	$V_{OUT} = 90\% \text{ of } V_{OUT(NOM)}$	300	600	--	mA	
Enable Threshold Voltage	H-Level	$V_{ENH}$	$V_{IN} = 5V$	0.5	0.7	0.9	V
	L-Level	$V_{ENL}$	$V_{IN} = 5V$	0.4	0.65	0.85	
Thermal Shutdown Temperature	$T_{SD}$	$I_{LOAD} = 30mA, V_{IN} \geq 1.5V$	--	150	--	$^{\circ}C$	
Thermal Shutdown Hysteresis	$\Delta T_{SD}$		--	20	--	$^{\circ}C$	
Discharge Resistance		$EN = 0V, V_{OUT} = 0.1V$	--	80	--	$\Omega$	

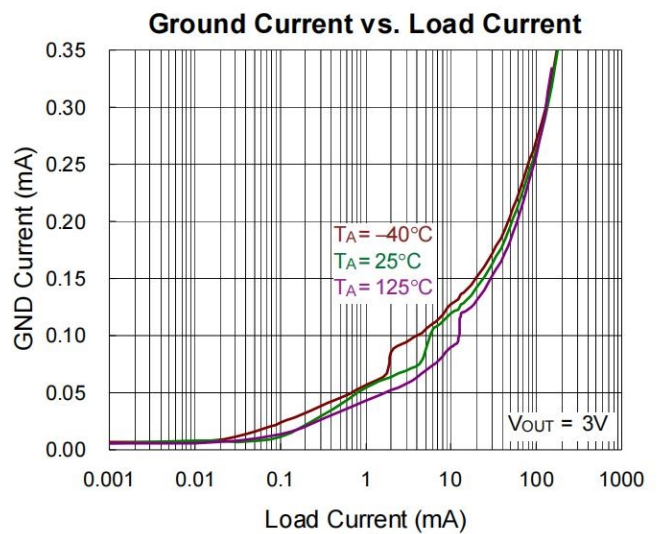
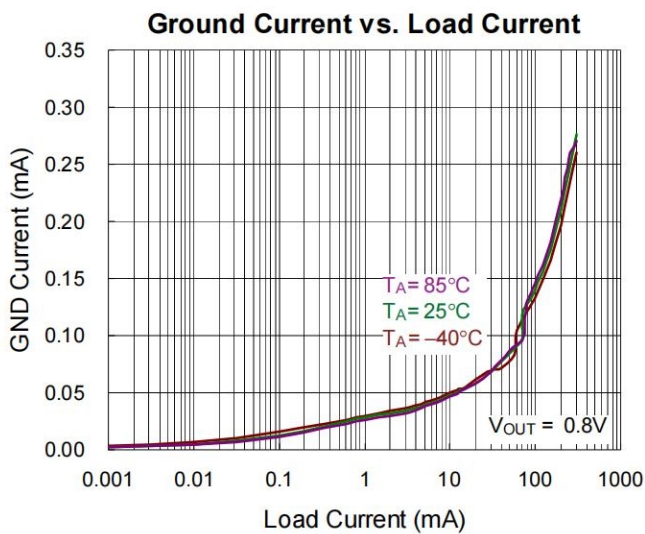
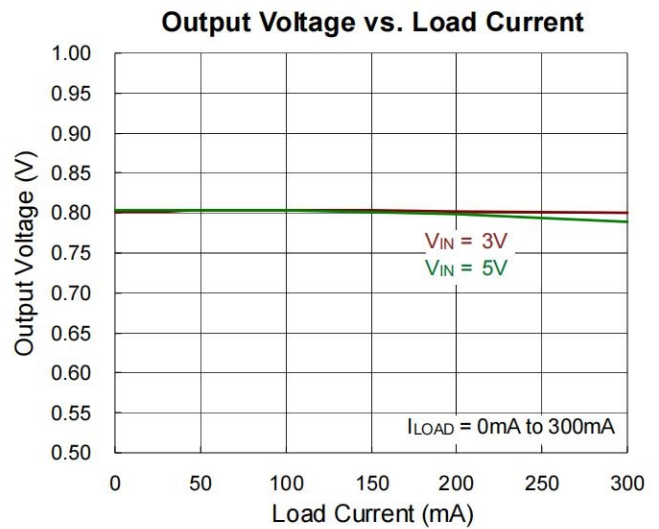
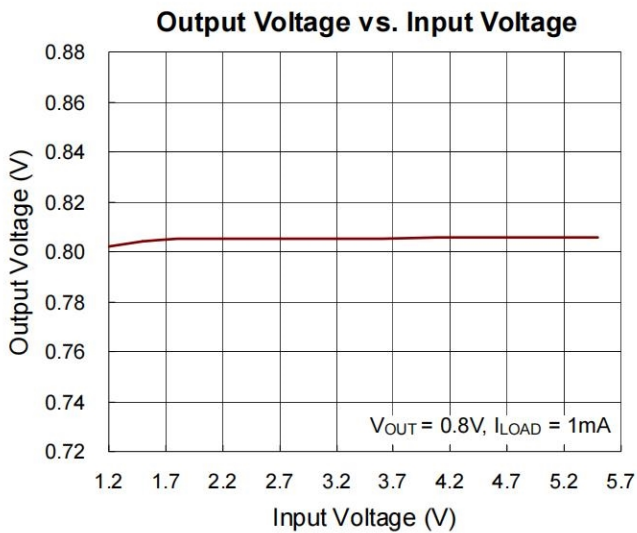
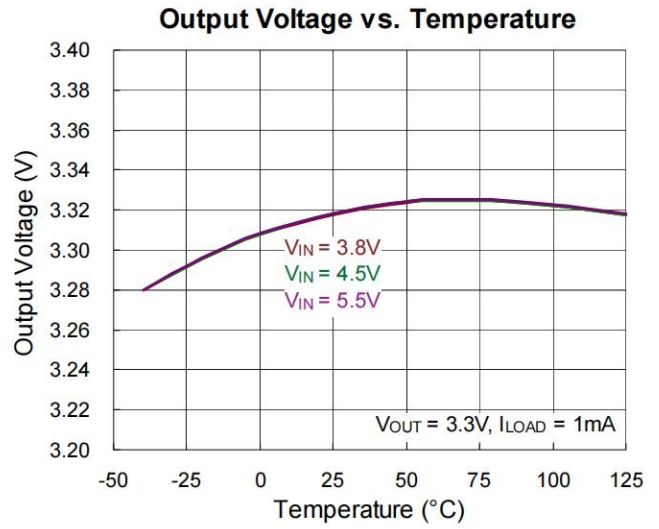
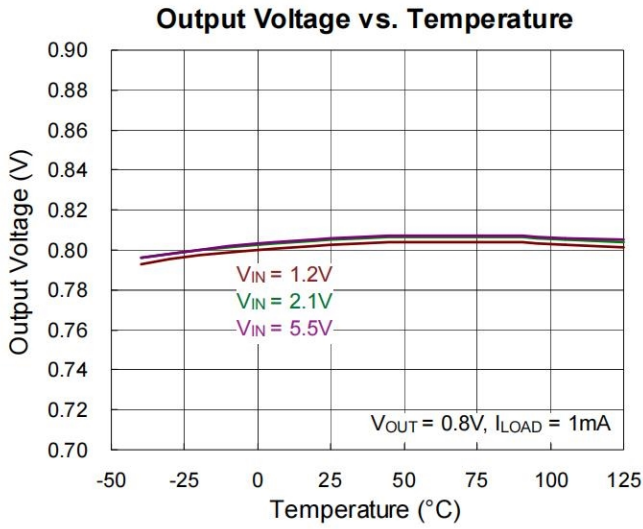
**TYPICAL APPLICATION**

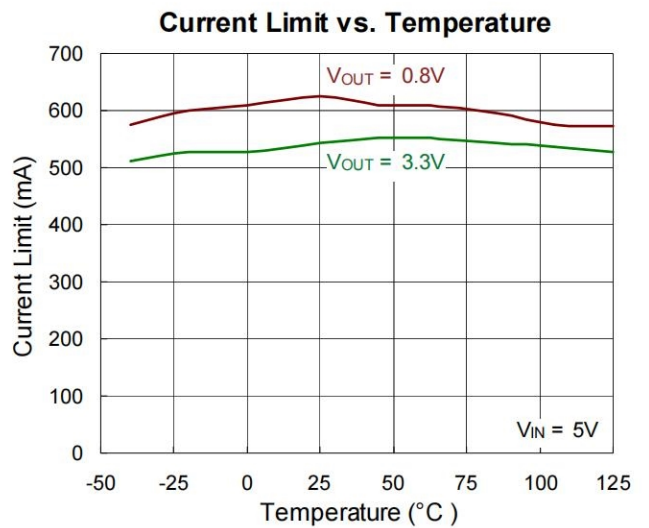
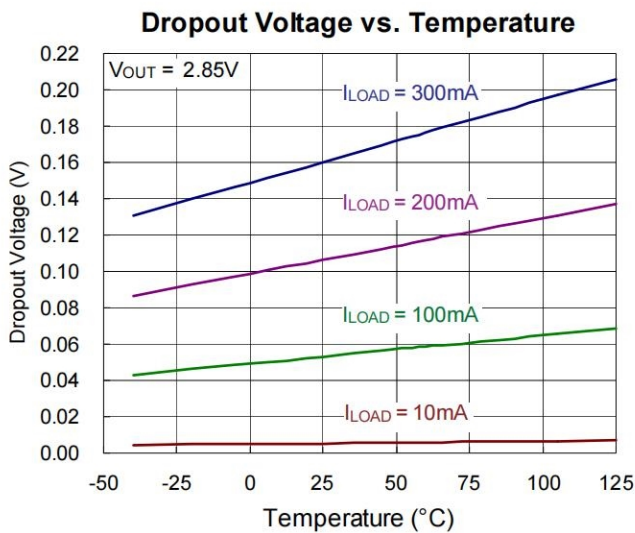
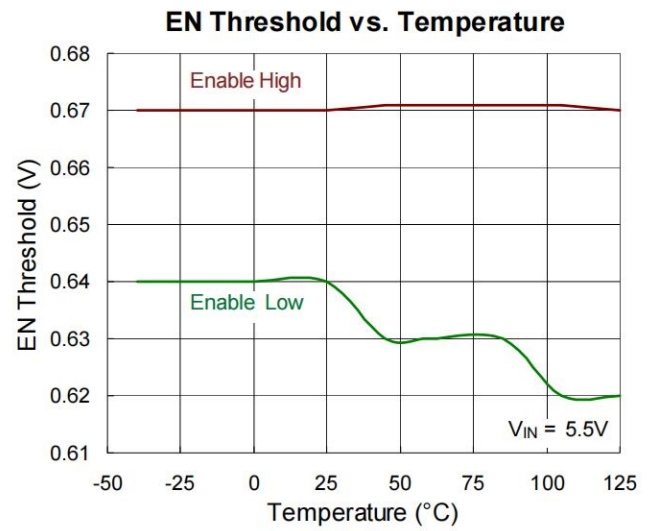
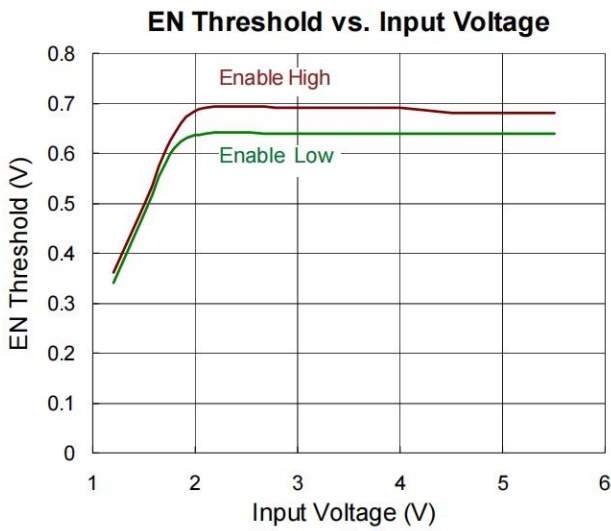
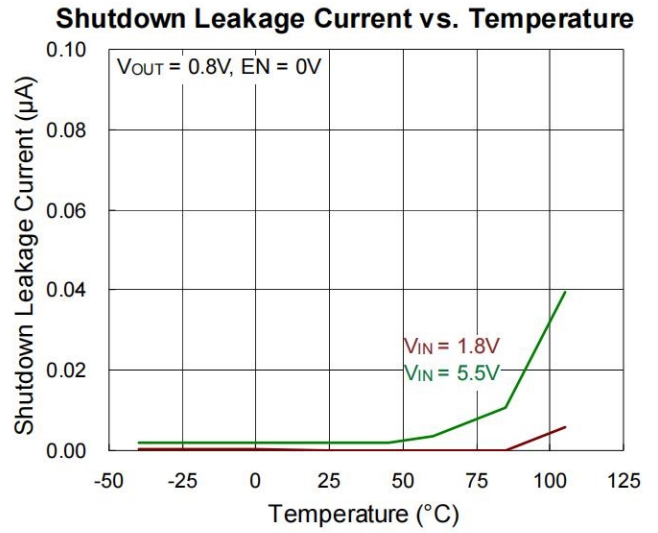
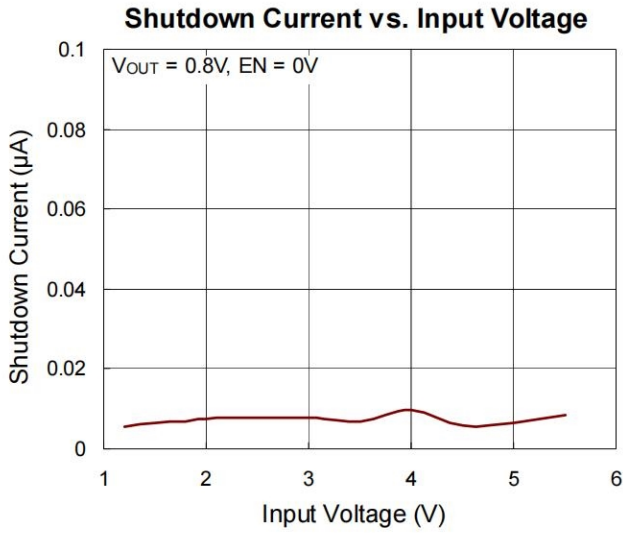


**Table 1. Recommended External Components**

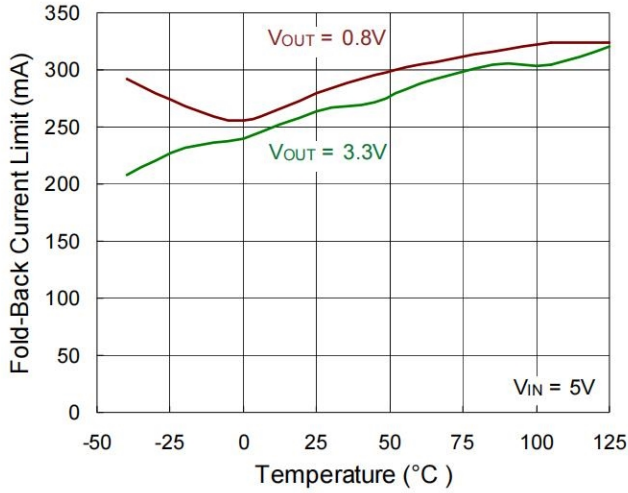
Component	Description	Vendor P/N
C <sub>IN</sub>	1µF, 10V, X5R, 0402	GRM155R61A105KE15 (Murata)
* C <sub>OUT</sub>	1µF, 6.3V, X5R, 0402	GRM153R60J105ME95(Murata) CGB2A3X5R0J105M033BB(TDK)
	2.2µF, 6.3V, X5R, 0402	GRM153R60J225ME95 (Murata) C1005X5R0J225M050BC (TDK)
	4.7µF, 6.3V, X5R, 0402	GRM153R60J475ME15 (Murata) C1005X5R0J475K050BE(TDK)

**Typical Operating Characteristics**

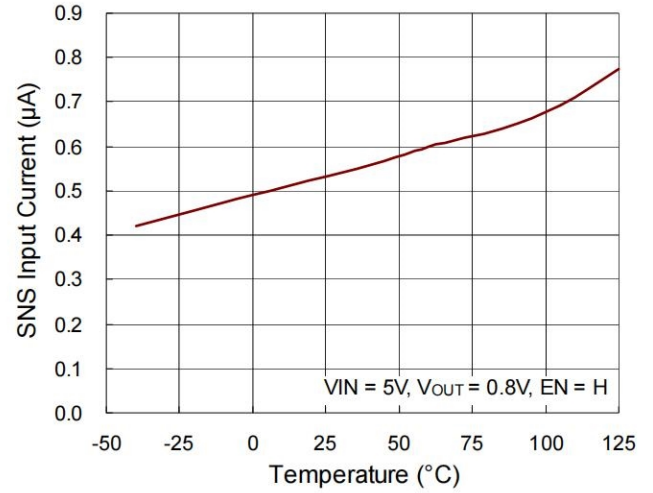




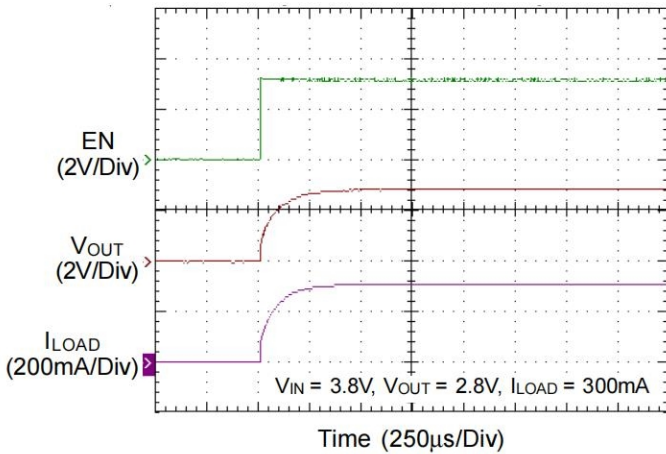
**Fold-Back Current Limit vs. Temperature**



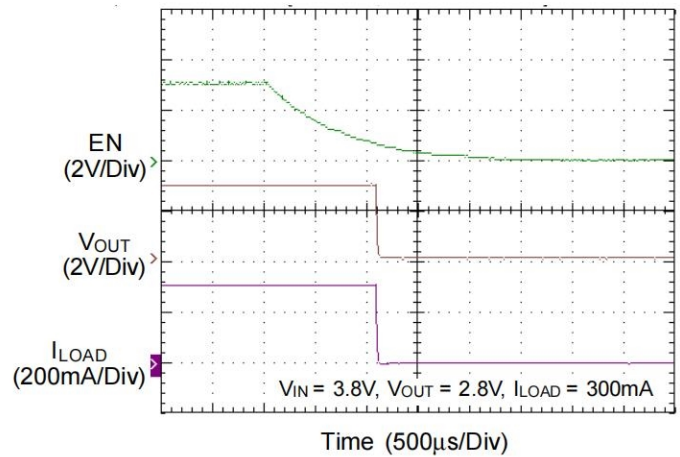
**SNS Input Current vs. Temperature**



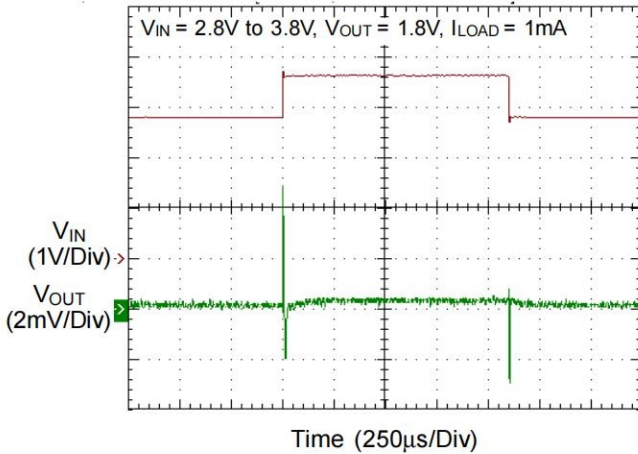
**Power On from EN**



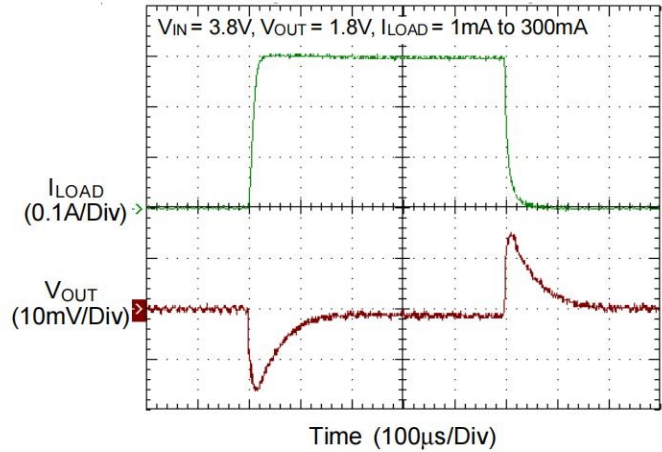
**Power Off from EN**



**Line Transient**

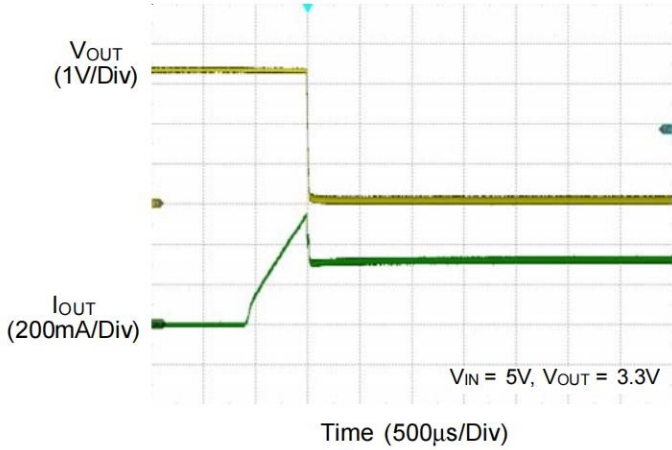


**Load Transient**

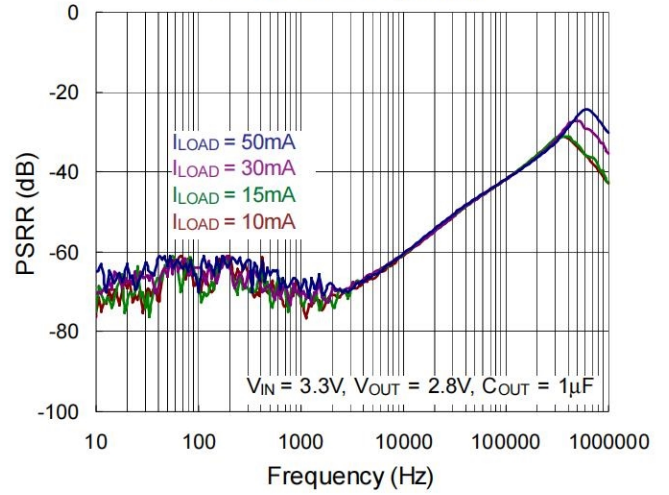




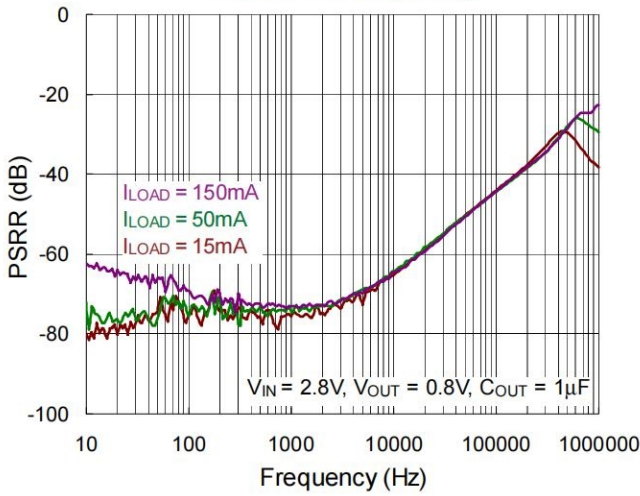
**Output Current Limit Protection**



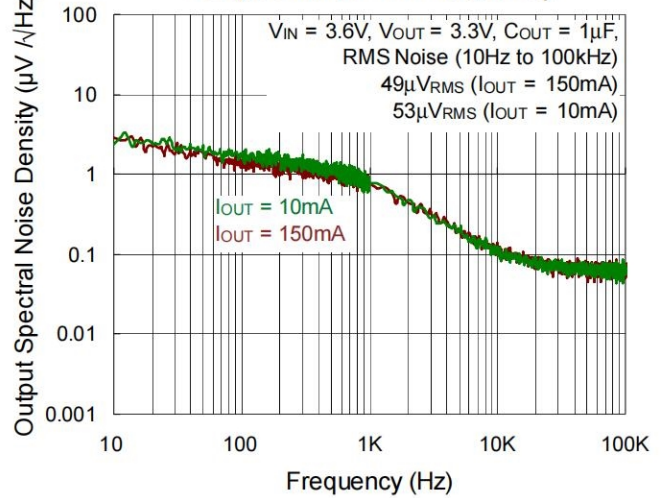
**PSRR vs. Frequency**



**PSRR vs. Frequency**

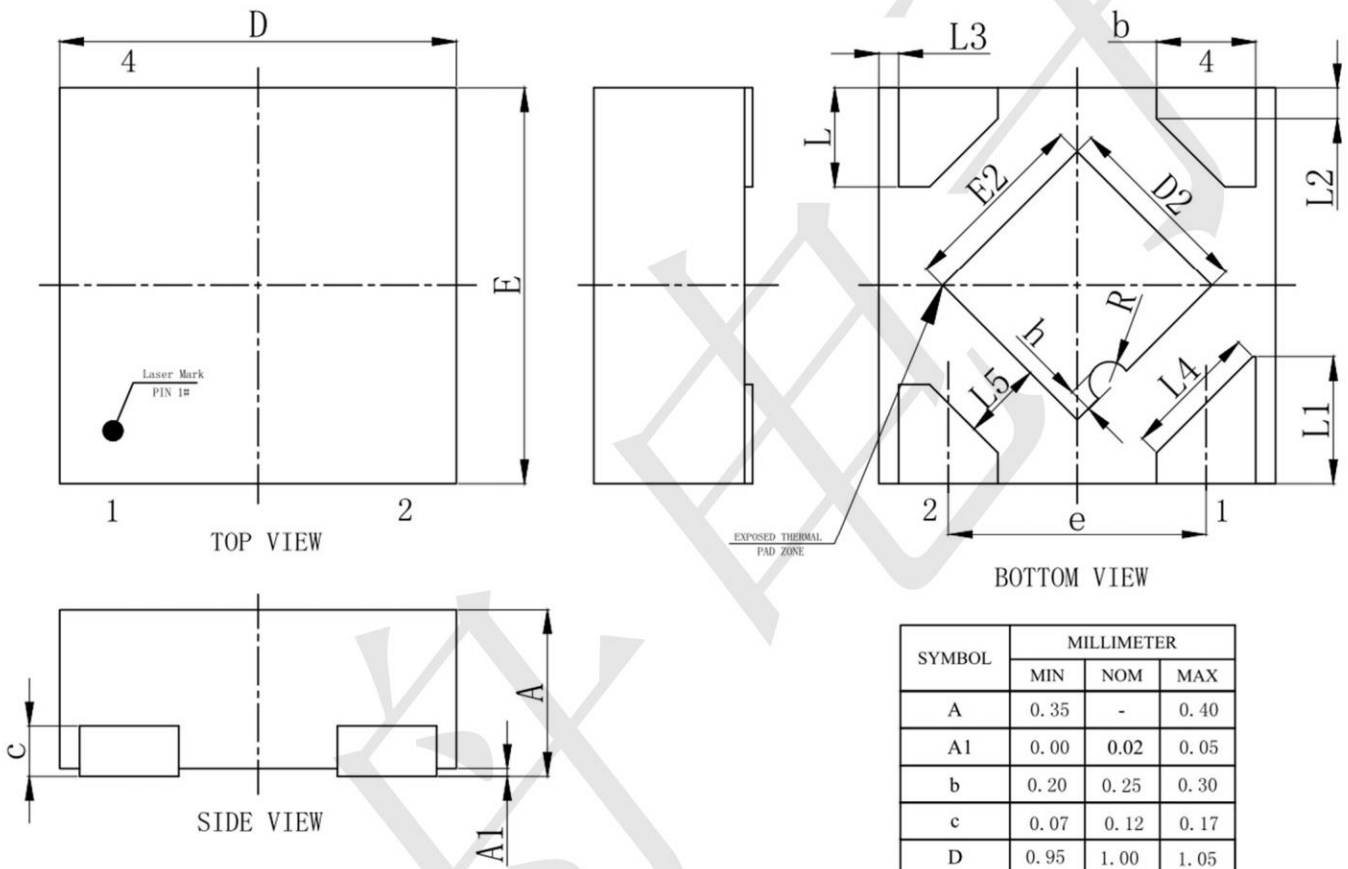


**Output Noise vs. Frequency**



**Package informantion**

DFN1X1-4 Outline Dimensions



SYMBOL	MILLIMETER		
	MIN	NOM	MAX
A	0.35	-	0.40
A1	0.00	0.02	0.05
b	0.20	0.25	0.30
c	0.07	0.12	0.17
D	0.95	1.00	1.05
D2	0.38	0.48	0.58
e	0.65BSC		
E	0.95	1.00	1.05
E2	0.38	0.48	0.58
L	0.20	0.25	0.30
L1	0.27	0.32	0.37
L2	0.077REF		
L3	0.05REF		
L4	0.34REF		
L5	0.20REF		
R	0.05REF		
h	0.06REF		