

Data Sheet

Customer :

Product : Automotive Grade Thin Film Precision Chip Resistor
– AR..A Series

Size: 0402/0603/0805/1206/1210/2010/2512

Issued Date: 10-Jan-18

Edition : REV.B6



VIKING TECH CORPORATION
光韻科技股份有限公司

No.70, Guangfu N. Rad.,
Hsin Chu Industrial Park,
Hukou Hsiang, Hsin Chu Hsien,
303, Taiwan

TEL:886-3-5972931

FAX:886-3-5972935•886-3-5973494

E-mail:sales@viking.com.tw

VIKING TECH CORPORATION KAOHSIUNG BRANCH
光韻科技股份有限公司高雄分公司

No.248-3, Sin-Sheng Rd., Cian-Jhen Dist., Kaohsiung,
806, Taiwan

TEL:886-7-8217999

FAX:886-7-8228229

E-mail:sales@viking.com.tw

Viking Electronics (WUXI) CO., LTD.
光韻電子(無錫)有限公司

No.1A,(Xixia Road),Machinery & Industry Park,
National Hi-Tech Industrial Development Zone of
Wuxi, Wuxi, Jiangsu Province, China

Zip Code:214028

TEL:86-510-85203339

FAX:86-510-85203667•86-510-85203977

E-mail:wuxisales@tmtec.com.tw

Produced by (QC)	Checked (QC)	Approved by (QC)	Prepared by (Sales)	Accepted by (Customer)
10-Jan-18	10-Jan-18	10-Jan-18	10-Jan-18	
Chun	Ben Chang	Ben Chang		

Automotive Grade Thin Film Precision Chip Resistor



■ Features

- AEC-Q200 Compliance
- Advanced thin film technology
- RoHS compliant
- Special materials, design, and processing for high sulfur applications
- Test proven immunity to humidity, moisture, and sulfur

■ Applications

- Automotive
- Medical Equipment
- Testing / Measurement Equipment
- Printer Equipment
- Automatic Equipment Controller
- Converters
- Communication Device, Cell Phone, GPS, PDA

■ Construction

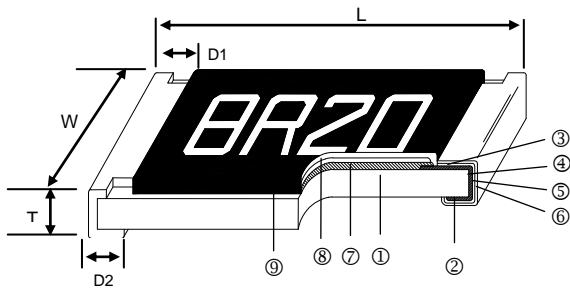

① Alumina Substrate	④ Edge Electrode	⑦ Resistor Layer
② Bottom Electrode	⑤ Barrier Layer	⑧ Overcoat
③ Top Electrode	⑥ External Electrode	⑨ Marking

■ Dimensions

Unit: mm

Type	Size (Inch)	L	W	T	D1	D2	Weight (g) (1000pcs)
AR02	0402	1.00±0.05	0.50±0.05	0.30±0.05	0.20±0.10	0.20±0.10	0.54
AR03	0603	1.55±0.10	0.80±0.10	0.45±0.10	0.30±0.20	0.30±0.20	1.83
AR05	0805	2.00±0.15	1.25±0.15	0.55±0.10	0.30±0.20	0.40±0.20	4.71
AR06	1206	3.05±0.15	1.55±0.15	0.55±0.10	0.42±0.20	0.35±0.25	9.02
AR13	1210	3.10±0.15	2.40±0.15	0.55±0.10	0.40±0.20	0.55±0.25	10
AR10	2010	4.90±0.15	2.40±0.15	0.55±0.10	0.60±0.30	0.50±0.25	23.61
AR12	2512	6.30±0.15	3.10±0.15	0.55±0.10	0.60±0.30	0.50±0.25	38.06

■ Part Numbering

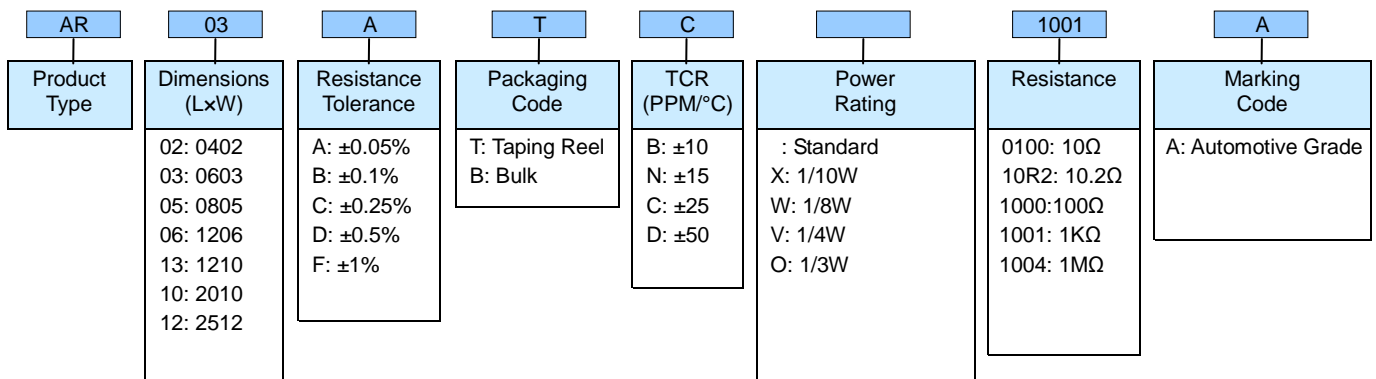

Derating Curve

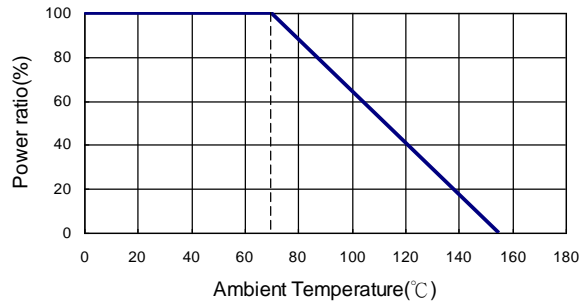

Standard Electrical Specifications

Type	Item	Power Rating at 70°C	Operating Temp. Range	Max. Operating Voltage	Max. Overload Voltage	Resistance Range					TCR (PPM/°C)
						±0.05%	±0.1%	±0.25%	±0.5%	±1%	
AR02 (0402)	1/16W	-55 ~ +155°C	25V	50V	49.9Ω - 10KΩ	49.9Ω - 100KΩ					±25 ±50
AR03 (0603)	1/16W	-55 ~ +155°C	50V	100V	10Ω - 49.9KΩ	10Ω - 332KΩ					±25 ±50
AR05 (0805)	1/10W	-55 ~ +155°C	100V	200V	10Ω - 100KΩ	10Ω - 1MΩ					±25 ±50
AR06 (1206)	1/8W	-55 ~ +155°C	150V	300V	10Ω - 200KΩ	10Ω - 1MΩ					±25 ±50
AR13 (1210)	1/4W	-55 ~ +155°C	150V	300V	10Ω - 499KΩ	10Ω - 1MΩ					±25 ±50
AR10 (2010)											
AR12 (2512)	1/2W	-55 ~ +155°C	150V	300V	10Ω - 499KΩ	10Ω - 1MΩ					±25 ±50

Special Electrical Specifications

Type	Item	Power Rating at 70°C	Operating Temp. Range	Max. Operating Voltage	Max. Overload Voltage	Resistance Range					TCR (PPM/°C)
						±0.05%	±0.1%	±0.25%	±0.5%	±1%	
AR02 (0402)	1/16W	-55 ~ +155°C	25V	50V	49.9Ω - 10KΩ					±10	
					49.9Ω - 10KΩ	49.9Ω - 69.8KΩ				±15	
AR03 (0603)	1/16W	-55 ~ +155°C	50V	100V	10Ω - 49K9Ω	10Ω - 332KΩ					±10 ±15
AR05 (0805)	1/10W	-55 ~ +155°C	100V	200V	10Ω - 100KΩ	10Ω - 511KΩ					±10
						10Ω - 1MΩ					±15
AR06 (1206)	1/8W	-55 ~ +155°C	150V	300V	10Ω - 200KΩ	10Ω - 1MΩ					±10 ±15
AR13 (1210)	1/ 4W	-55 ~ +155°C	150V	300V	10Ω - 499KΩ	10Ω - 1MΩ					±10 ±15
AR10 (2010)	1/4W	-55 ~ +155°C	150V	300V	10Ω - 499KΩ	10Ω - 1MΩ					±10 ±15
AR12 (2512)	1/2W	-55 ~ +155°C	150V	300V	10Ω - 499KΩ	10Ω - 1MΩ					±10 ±15

High Power Rating Electrical Specifications

Item Type	Power Rating at 70°C	Operating Temp. Range	Max. Operating Voltage	Max. Overload Voltage	Resistance Range					TCR (PPM/°C)
					±0.05%	±0.1%	±0.25%	±0.5%	±1%	
AR03(0603)	1/10W	-55 ~ +155°C	75V	150V	10Ω - 49.9KΩ	10Ω - 332KΩ				±10 ±15 ±25 ±50
AR05(0805)	1/8W	-55 ~ +155°C	150V	300V	10Ω - 100KΩ	10Ω - 511KΩ				±10 ±15 ±25 ±50
AR06(1206)	1/4W	-55 ~ +155°C	200V	400V	10Ω - 200KΩ	10Ω - 1MΩ				±10 ±15 ±25 ±50
AR13(1210)	1/ 3W	-55 ~ +155°C	200V	400V	10Ω - 499KΩ	10Ω - 1MΩ				±10
AR10(2010)										±15 ±25 ±50

Operating Voltage= $\sqrt{P \cdot R}$ or Max. operating voltage listed above, whichever is lower.
 Overload Voltage= $2.5 \cdot \sqrt{P \cdot R}$ or Max. overload voltage listed above, whichever is lower.

■Viking is capable of manufacturing the optional spec based on customer's requirement.

Environmental Characteristics

Item	Requirement		Test Method
	Tol. ≤ 0.05%	Tol. > 0.05%	
Temperature Coefficient of Resistance (T.C.R.)	As Spec.		JIS-C-5201-1 4.8 IEC-60115-1 4.8 -55°C~+125°C, 25°C is the reference temperature
Short Time Overload	ΔR±0.05%		JIS-C-5201-1 4.13 RCWV*2.5 or Max. overload voltage whichever is lower for 5 seconds
Insulation Resistance	>1000 MΩ		JIS-C-5201-1 4.6 IEC-60115-1 4.6 Apply 100V _{DC} for 1 minute
Operational Life	ΔR±0.05%	ΔR±0.2%	MIL-STD-202 Method 108 Condition D Steady State T _A =125°C at derated power. Measurement at 24±4 hours after test conclusion.
	>7kΩ ΔR±0.2%		
	ΔR±0.5% for high power rating		
Biased Humidity	ΔR±0.1%		MIL-STD-202 Method 103 1000 hrs 85°C/85%RH 10% of operating power.
High Temperature Exposure	ΔR±0.2%		MIL-STD-202 Method 108 at +155°C for 1000 hrs
Temperature Cycling	ΔR±0.1%		JESD22 Method JA-104 -55°C to +125°C, 1000 cycles
Bending Strength (Board Flex)	ΔR±0.1%		JIS-C-5201-1 4.33 Bending once for 60 seconds Bending displacement: 2010 2512 sizes: 2 mm Other sizes: 3 mm
Solderability	95% min. coverage		JIS-C-5201-1 4.17 IEC-60115-1 4.17 245±5°C for 3 seconds
Resistance to Soldering Heat	ΔR±0.05%		JIS-C-5201-1 4.18 IEC-60115-1 4.18 260±5°C for 10 seconds
Terminal strength	No broken		AEC-Q200-006 Force of 1.8kg for 60 seconds.

Mechanical Shock	$\Delta R \pm 0.05\%$	$\Delta R \pm 0.1\%$	MIL-STD-202 Method 213 Wave Form: Tolerance for half sine shock pulse. Peak value is 100g's. Normal duration (D) is 6.
Vibration	$\Delta R \pm 0.05\%$	$\Delta R \pm 0.1\%$	MIL-STD-202 Method 204 5 g's for 20 min., 12 cycles each of 3 orientations, 10-2000 Hz
ESD	$\Delta R \pm 0.5\%$		AEC-Q200-002 Human body model AR02、AR03 0.2KV AR05、AR06 1KV AR10、AR12、AR13 2KV
Resistance to solvents	Marking Unsmearred		MIL-STD-202 Method 215 Add Aqueous wash chemical - OKEM Clean or equivalent. Do not use banned solvents.
Sulfur Test	$\Delta R \pm 1\%$		EIA-977(Conditions B) 105±2 °C no power rating for 750 hrs.
Flammability	No ignition of the tissue paper or scorching or the pinewood board		UL-94 V-0 or V-1 are acceptable. Electrical test not required.

RCWV(Rated continuous working voltage)= $\sqrt{P \cdot R}$ or Max. Operating voltage whichever is lower

■ Storage Temperature: 15~28°C; Humidity < 80%RH

■ Soldering Condition

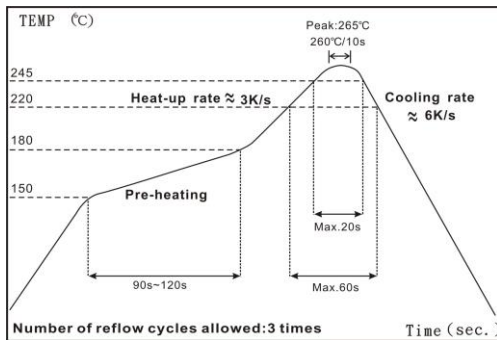

IR Reflow Soldering

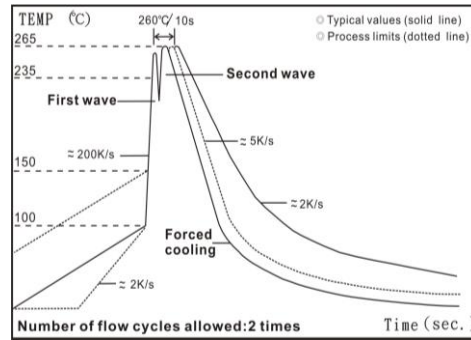

Wave Soldering (Flow Soldering)

- (1) Time of IR reflow soldering at maximum temperature point 260°C : 10s
- (2) Time of wave soldering at maximum temperature point 260°C : 10s
- (3) Time of soldering iron at maximum temperature point 410°C : 5s

■ Marking

0603 3digit marking



3digit marking for Example: 14C=13K7Ω 13C=13K3Ω
68B=4K99Ω 68X=49.9Ω

0603 3digit marking for E24

Example: 101=100Ω 102=1KΩ

E24	10	11	12	13	15	16	18	20	22	24	27	30	33	36	39	43	47	51	56	62	68	75	82	91
-----	----	----	----	----	----	----	----	----	----	----	----	----	----	----	----	----	----	----	----	----	----	----	----	----

0805-2512 4digit marking

Example

Resistance	100Ω	2.2KΩ	10KΩ	49.9KΩ	100KΩ
marking	1000	2201	1002	4992	1003

Marking Table

Code	E96	Code	E96	Code	E96	Code	E96				
01	100	25	178	49	316	73	562				
02	102	26	182	50	324	74	576				
03	105	27	187	51	332	75	590				
04	107	28	191	52	340	76	604				
05	110	29	196	53	348	77	619				
06	113	30	200	54	357	78	634				
07	115	31	205	55	365	79	649				
08	118	32	210	56	374	80	665				
09	121	33	215	57	383	81	681				
10	124	34	221	58	392	82	698				
11	127	35	226	59	402	83	715				
12	130	36	232	60	412	84	732				
13	133	37	237	61	422	85	750				
14	137	38	243	62	432	86	768				
15	140	39	249	63	442	87	787				
16	143	40	255	64	453	88	806				
17	147	41	261	65	464	89	825				
18	150	42	267	66	475	90	845				
19	154	43	274	67	487	91	866				
20	158	44	280	68	499	92	887				
21	162	45	287	69	511	93	909				
22	165	46	294	70	523	94	931				
23	169	47	301	71	536	95	953				
24	174	48	309	72	549	96	976				
Code	A	B	C	D	E	F	G	H	X	Y	Z
Multiplier	10 ⁰	10 ¹	10 ²	10 ³	10 ⁴	10 ⁵	10 ⁶	10 ⁷	10 ⁻¹	10 ⁻²	10 ⁻³

■Packaging

Packing Quantity & Reel Specifications

Unit :mm

Type	ØA	ØB	ØC	W	T	Paper Tape (EA)	Emboss Plastic Tape (EA)
AR02	178.0±1.0	60.0±1.0	13.5±0.7	9.5±1.0	11.5±1.0	10,000	-
AR03	178.0±1.0	60.0±1.0	13.5±0.7	9.5±1.0	11.5±1.0	5,000	-
AR05	178.0±1.0	60.0±1.0	13.5±0.7	9.5±1.0	11.5±1.0	5,000	-
AR06	178.0±1.0	60.0±1.0	13.5±0.7	9.5±1.0	11.5±1.0	5,000	-
AR13	178.0±1.0	60.0±1.0	13.5±0.7	9.5±1.0	11.5±1.0	5,000	-
AR10	178.0±1.0	60.0±1.0	13.5±0.7	13.5±1.0	15.5±1.0	-	4,000
AR12	178.0±1.0	60.0±1.0	13.5±0.7	13.5±1.0	15.5±1.0	-	4,000



Paper Tape Specifications



Unit: mm

Type	A	B	W	E	F	P ₀	P ₁	P ₂	ΦD ₀	T
AR02	0.70±0.05	1.16±0.05	8.00±0.10	1.75±0.05	3.5±0.05	4.00±0.10	2.00±0.05	2.00±0.05	1.55±0.05	0.40±0.03
AR03	1.10±0.05	1.90±0.05	8.00±0.10	1.75±0.05	3.5±0.05	4.00±0.10	4.00±0.10	2.00±0.05	1.55±0.05	0.60±0.03
AR05	1.60±0.05	2.37±0.05	8.00±0.10	1.75±0.05	3.5±0.05	4.00±0.10	4.00±0.10	2.00±0.05	1.55±0.05	0.75±0.05
AR06	2.00±0.05	3.55±0.05	8.00±0.10	1.75±0.05	3.5±0.05	4.00±0.10	4.00±0.10	2.00±0.05	1.55±0.05	0.75±0.05
AR13	2.75±0.05	3.40±0.05	8.00±0.10	1.75±0.05	3.5±0.05	4.00±0.05	4.00±0.10	2.00±0.05	1.60±0.10	0.75±0.05

- Peel force of top cover tape
- The peel speed shall be about 300mm/min±5%
- The peel force of top cover tape shall be between 8gf to 60gf

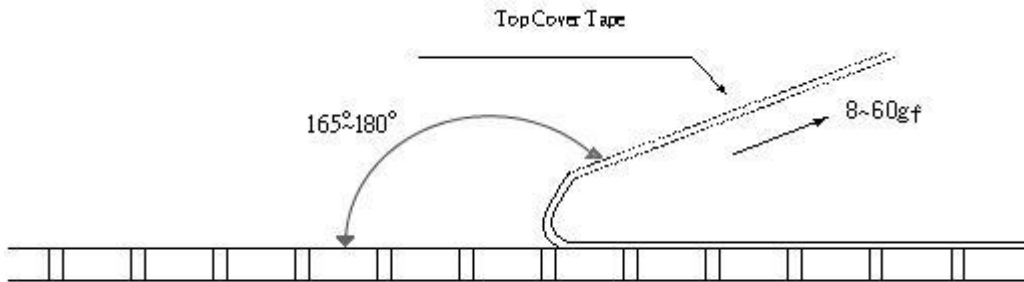

Emboss Plastic Tape Specifications



Unit: mm

Type	A	B	W	E	F	P ₀	P ₁	P ₂	ØD ₀	T
AR10	2.85±0.10	5.45±0.10	12.0±0.10	1.75±0.10	5.5±0.05	4.00±0.05	4.00±0.10	2.00±0.05	1.50±0.10	1.00±0.20
AR12	3.40±0.10	6.65±0.10	12.0±0.10	1.75±0.10	5.5±0.05	4.00±0.05	4.00±0.10	2.00±0.05	1.50±0.10	1.00±0.20

- Peel force of top cover tape
- The peel speed shall be about 300mm/min±5%
- The peel force of top cover tape shall be between 20gf to 80gf

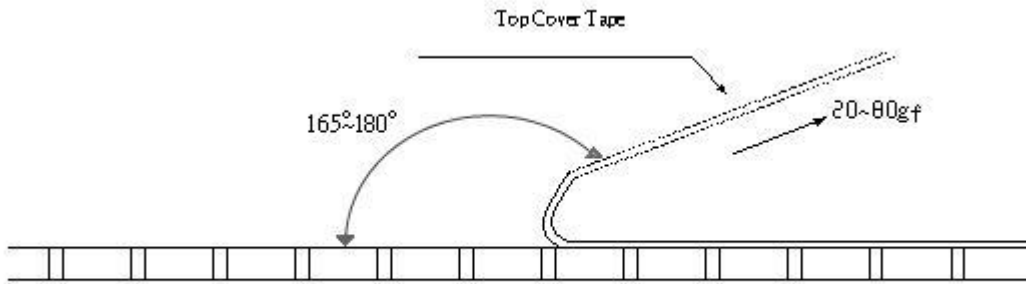

Recommend Land Pattern

Unit: mm

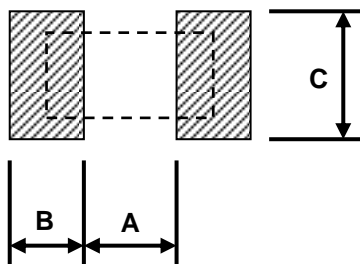

Type	A	B	C
AR02	0.50	0.50	0.60±0.2
AR03	0.80	1.00	0.90±0.2
AR05	1.00	1.00	1.35±0.2
AR06	2.00	1.15	1.70±0.2
AR13	2.00	1.15	2.50±0.2
AR10	3.60	1.40	2.50±0.2
AR12	4.90	1.60	3.10±0.2

REVISION HISTORY

REVISION	DATE	CHANGE NOTIFICATION	DESCRIPTION
Version A5	May 07.2013	-	- Correct the scheme.
Version A6	Aug 20.2013	-	- Delete Thermal Shock & Moisture Resistance Tests (Follow AEC-Q200 Rev.D)
Version A7	Oct 24.2013	-	- Update product features description and add a reliability test item.
Version A8	May 21.2014	-	- Correct the scheme.
Version A9	Sep 25 ,2014	-	- Correct the specification of top cover tape peel force.
Version B	Apr 24 ,2015	-	- Add TCR ± 10 ppm and ± 15 ppm products specification. - Revise reliability specification. - Correct the element of Top Electrode.
Version B1	Jan 08 ,2016	-	- Modify Storage Temperature.
Version B2	May 02 ,2016	-	- Remove Material Description.
Version B3	Dec 14 ,2016	-	- Revise the requirements of Environmental Characteristics.
Version B4	Oct 27 ,2017	-	- Correct the reference standard in Environmental Characteristics. - Add Soldering Condition.
Version B5	Dec 25 ,2017	-	- Correct the reference standard in Environmental Characteristics.
Version B6	Jan 10 ,2018	-	- Correct the reference standard in Environmental Characteristics.