

CUSTOMER :

Doc No : MES003702

Rev : A0

RoHS Comp.

Halogen Free

承認書

APPROVAL SHEET

Specifications description : CAP PL 100uF 25V Φ 6.3*9.0 mm
Dip \pm 20%, 2000hrs

APAQ P/N : 250AREA101M0609

Customer P/N :

Date	Approved by	Checked by
		

Approved by Customer
(Signing or stamping here) :

Approved Date :



鈺邦科技股份有限公司

APAQ TECHNOLOGY CO., LTD

竹南科學園區

苗栗縣竹南鎮科東三路 2&6 號 4 樓

4F., No.2 & 6, Kedong 3rd Rd., Chunan Science

Park, Miaoli County 350, Taiwan ,(R.O.C.)

AP-CON AREA SERIES SPECIFICATION

1. Application

This specification shall be specified to conductive polymer aluminum solid electrolytic capacitors of AREA series.

2. Composition of part number

160 AREA 102 M 1012
 Rated voltage Series code Capacitance Cap tolerance Size code

2.1 Rated voltage code

Table 1 Rated voltage and surge voltage

Rated voltage code	Rated voltage (V)	Surge voltage (V)
2R5	2.5	2.9
4R0	4	4.6
6R3	6.3	7.2
100	10	11.5
160	16	18.4
250	25	28.8

2.2 Capacitance code

Table 2 Rated capacitance

Capacitance code	Capacitance (Uf)
3R3	3.3
100	10
821	820
122	1200

2.3 Capacitance tolerance code

Table 3 Capacitance tolerance

Cap tolerance code	Cap tolerance
M	±20%

THIS DRAWINGS AND SPECIFICATIONS ARE THE PROPERTY OF APAQ TECHNOLOGY CO. LTD AND SHALL NOT BE REPRODUCT OR USED AS THE BASIC FOR THE MANUFACTURE OR SALE OF APPARATUS OR DEVICES WITHOUT PERMISSION.



鈺邦科技股份有限公司

APAQ TECHNOLOGY CO., LTD

DESIGNED BY : 陳明宗

DRAWN BY : 呂姿儀

CHECKED BY : 林軒逸

APPROVED BY : 錢明谷

TITLE : AP-CON AREA SERIES SPECIFICATION

DOCUMENT NO.

MES003702

REV

A0

2.4 Size code

Table 4 Dimension of radial type capacitors

Size code	Diameter (mm)	Case length (mm)
0509	5.0	9.0
0510	5.0	10.0
0606	6.3	6.0
0609	6.3	9.0
0809	8.0	9.0
0812	8.0	12.0
1012	10.0	12.0

3. Rating

3.1 Category temperature range

-55 to +105 °C

3.2 Surge voltage

Rated voltage * 1.15

3.3 Rated ripple current

Rated ripple current shall be in accordance with standard ratings list. These current are rms values of sine wave of 100kHz at 105 °C.

3.4 Standard ratings

Table 5 Standard ratings

WV/Vdc (SV)	Cap (μF)	Size Code	Leakage Current (μA)	tanδ	ESR (mΩmax/20%, 100k to300kHz)	Rated Ripple Current (mArms/ 105°C/100kHz)	Part No.
25 (28.8)	100	0609	500	0.12	20	2,900	250AREA101M0609

THIS DRAWINGS AND SPECIFICATIONS ARE THE PROPERTY OF APAQ TECHNOLOGY CO. LTD AND SHALL NOT BE REPRODUCT OR USED AS THE BASIC FOR THE MANUFACTURE OR SALE OF APPARATUS OR DEVICES WITHOUT PERMISSION.



鈺邦科技股份有限公司

APAQ TECHNOLOGY CO., LTD

DESIGNED BY : 陳明宗

DRAWN BY : 呂姿儀

CHECKED BY : 林軒逸

APPROVED BY : 錢明谷

TITLE : AP-CON AREA SERIES SPECIFICATION

DOCUMENT
NO.

MES003702

REV

A0

4. Construction and dimensions.

4.1 Construction

Radial type capacitors shall be enclosed wound element, where anode and cathode foils with lead wire termination shall be wound together with separator, with conductive polymer electrolyte in a plastic coated aluminum case and sealed up tightly with rubber.

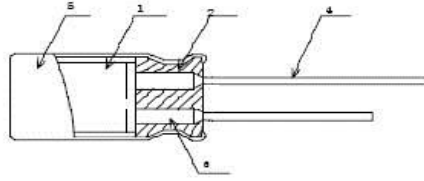

Fig. 1 Cross-section view

Table 6 Construction

Compositions		Materials
1	Element	Anode foil
		Cathode foil
		Separator
2	Seal	Rubber
3	Aluminum tab	Aluminum
4	Lead wire	Tinned Lead
5	Case	Plastic coated aluminum

4.2 Outer dimensions

Outer dimensions shall be in accordance with Fig. 2, and the dimensions in each size shall be specified on Table 7.

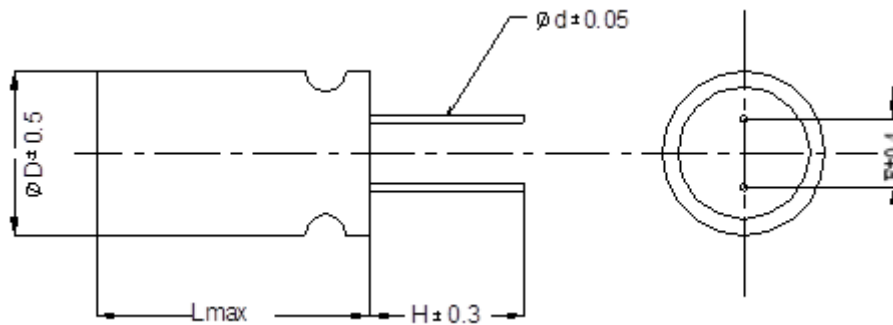

Fig. 2 Dimension

THIS DRAWINGS AND SPECIFICATIONS ARE THE PROPERTY OF APAQ TECHNOLOGY CO. LTD AND SHALL NOT BE REPRODUCT OR USED AS THE BASIC FOR THE MANUFACTURE OR SALE OF APPARATUS OR DEVICES WITHOUT PERMISSION.



鈺邦科技股份有限公司

APAQ TECHNOLOGY CO., LTD

DESIGNED BY : 陳明宗

DRAWN BY : 呂姿儀

CHECKED BY : 林軒逸

APPROVED BY : 錢明谷

TITLE : AP-CON AREA SERIES SPECIFICATION

DOCUMENT NO.

MES003702

REV

A0

Table 7 Dimension

Size code	$\Phi D \pm 0.5$ (mm)	Lmax (mm)	$\Phi d \pm 0.05$ (mm)	F ± 0.4 (mm)	H ± 0.3 (mm)
0509	5.0	9.0	0.5	2.0	3.2
0510	5.0	10.0	0.5	2.0	3.2
0606	6.3	6.0	0.45	2.5	3.2
0609	6.3	9.0	0.6	2.5	3.2
0809	8.0	9.0	0.6	3.5	3.2
0812	8.0	12.0	0.6	3.5	3.2
1012	10.0	12.0	0.6	5.0	3.2

5. Marking

The following items shall be marked on each capacitor, as showed in Fig. 3.

- (1) Polarity
- (2) Series
- (3) Year code: U-2014,V-2015,W-2016,X-2017
- (4) Production period code
- (5) Manufacturer's identification mark
- (6) Rated capacitance
- (7) Rated voltage
- (8) The color of marking ink is Red.

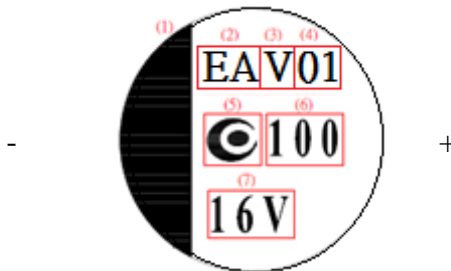

Figure 3 Marking

THIS DRAWINGS AND SPECIFICATIONS ARE THE PROPERTY OF APAQ TECHNOLOGY CO. LTD AND SHALL NOT BE REPRODUCT OR USED AS THE BASIC FOR THE MANUFACTURE OR SALE OF APPARATUS OR DEVICES WITHOUT PERMISSION.



鈺邦科技股份有限公司

APAQ TECHNOLOGY CO., LTD

DESIGNED BY : 陳明宗

DRAWN BY : 呂姿儀

CHECKED BY : 林軒逸

APPROVED BY : 錢明谷

TITLE : AP-CON AREA SERIES SPECIFICATION

DOCUMENT NO.

MES003702

REV

A0

6. The electrical and mechanical performance and testing method

6.1 Measurement condition

Each measurement shall be conducted at a temperature of 15 to 35 °C, and relative humidity of 45 to 85%. Furthermore, these measurements shall be preferably conducted at a temperature of 20±2 °C, and relative humidity of 60 to 70%, while the capacitors shall be kept enough time in the measuring temperature.

6.2 Voltage treatment

If leakage current is doubtful, measure it after performing voltage treatment, which shall contain the following steps:

- (1) Applied DC rated voltage to the capacitors for 60 minutes at 105±2 °C.
- (2) Cooled down to room temperature with applying voltage.
- (3) Discharged through a resistor of approximately 1Ω/V.

6.3 Electrical performance

6.3.1 Tolerance on rated capacitance

Rated capacitance shall meet within -20% to +20% (M) tolerance against the rated capacitance measured at 120Hz±10% at 20±2 °C.

6.3.2 Leakage current

DC rated voltage shall be applied between anode and cathode lead wire terminations of a capacitor through 1kΩ protective resistance, and the leakage current shall be less than or equal to the value listed in table 5 after 2 minutes with the voltage reaching the rated value at 20±2 °C.

If the value is doubtful, measure the leakage current after performing voltage treatment as described in section 6.2.

6.3.3 Tangent of loss angle (tanδ)

Tanδ values shall be less than or equal to 0.12 measured at 120Hz±10% at 20±2 °C.

THIS DRAWINGS AND SPECIFICATIONS ARE THE PROPERTY OF APAQ TECHNOLOGY CO. LTD AND SHALL NOT BE REPRODUCT OR USED AS THE BASIC FOR THE MANUFACTURE OR SALE OF APPARATUS OR DEVICES WITHOUT PERMISSION.



鈺邦科技股份有限公司

APAQ TECHNOLOGY CO., LTD

DESIGNED BY : 陳明宗

DRAWN BY : 呂姿儀

CHECKED BY : 林軒逸

APPROVED BY : 錢明谷

TITLE : AP-CON AREA SERIES SPECIFICATION

DOCUMENT NO.

MES003702

REV

A0

6.3.4 Equivalent Series Resistance (ESR)

ESR at 100kHz measured under the following conditions listed in Table 8 shall be less than or equal to the value in Table 5.

Table 8 Measurement requirement of ESR

Equipment	Agilent Technology 4263B or equivalent
Test Fixture	Agilent Technology 16047E or equivalent
Compensation	Short and Open compensation would be required. Short correction is performed using the shorting plate made of 0.5 thickness copper plate with gold coating.
Signal Level	500mV
Frequency	100kHz
Measurement Point	Point of lead wire within 1mm form the body

6.3.5 Impedance at high and low temperature

Impedance at 100kHz at $-55\pm 3^{\circ}\text{C}$ or $105\pm 2^{\circ}\text{C}$ shall meet the values listed in Table 9.

Table 9 Impedance at low or high temperature

Impedance ratio	Performance
$Z(-55^{\circ}\text{C})/Z(+20^{\circ}\text{C})$	≤ 1.25
$Z(105^{\circ}\text{C})/Z(+20^{\circ}\text{C})$	≤ 1.25

6.4 Mechanical performance

6.4.1 Pull strength of lead wire terminations

With the body of a capacitor fixed, the load listed in Table 10 shall be applied to the lead wire termination in its draw out direction, gradually up to the specified value and held for 10 ± 1 seconds. After this test, that capacitor shall not appear any change defective in use.

Table 10 Pull strength load of lead wire terminations

Case diameter (mm)	Load strength (N)	Load strength (kgf)
$\Phi 4$	2.5	0.255
$\Phi 5$	5	0.51
$\Phi 6.3$	5	0.51
$\Phi 8$	10	1.0
$\Phi 10$	10	1.0

THIS DRAWINGS AND SPECIFICATIONS ARE THE PROPERTY OF APAQ TECHNOLOGY CO. LTD AND SHALL NOT BE REPRODUCT OR USED AS THE BASIC FOR THE MANUFACTURE OR SALE OF APPARATUS OR DEVICES WITHOUT PERMISSION.



鈺邦科技股份有限公司

APAQ TECHNOLOGY CO., LTD

DESIGNED BY : 陳明宗

DRAWN BY : 呂姿儀

CHECKED BY : 林軒逸

APPROVED BY : 錢明谷

TITLE : AP-CON AREA SERIES SPECIFICATION

DOCUMENT NO.

MES003702

REV

A0

6.4.2 Bending strength of lead wire terminations

Bending strength load listed in Table 11 shall be hung at the end of the lead wire termination, and the body of a capacitor shall be bent 90° and return to its original position. This operation shall be performed around 2 to 3 seconds. Then the body shall be bent 90° at the opposite direction and return to its original position at same speed. At this test, that capacitor shall no appear any change defective in use.

Table 11 Bending strength load of lead wire terminations

Case diameter (mm)	Load strength (N)	Load strength (kgf)
Φ4	1.25	0.127
Φ5	2.5	0.255
Φ6.3	2.5	0.255
Φ8	5	0.51
Φ10	5	0.51

6.4.3 Vibration

Vibration cycle should vary from 10 to 55Hz with total amplitude of 1.5mm and return to 10Hz in about 1 minute. Vibration applied to a capacitor should be three directions, which each perpendicular to the other two as longitudinal axis of capacitor set as z axis, and last for 2 hours in each direction. During this test, measured electrical value shall be stabilized when that capacitor is measured 5 times within 30 minutes before completion of test, and the appearance shall not appear any remarkable abnormality. A capacitor shall be fixed at the point of 4mm or less from the body as shown in Figure 4.

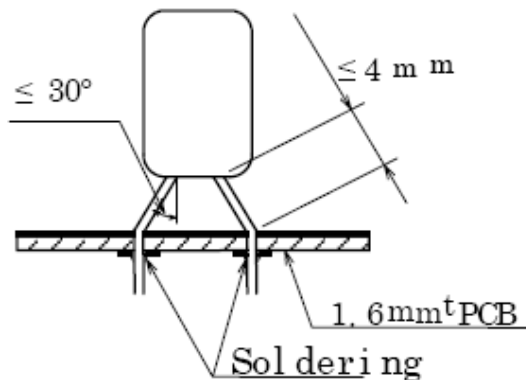

Figure 4 Vibration test

THIS DRAWINGS AND SPECIFICATIONS ARE THE PROPERTY OF APAQ TECHNOLOGY CO. LTD AND SHALL NOT BE REPRODUCT OR USED AS THE BASIC FOR THE MANUFACTURE OR SALE OF APPARATUS OR DEVICES WITHOUT PERMISSION.



鈺邦科技股份有限公司

APAQ TECHNOLOGY CO., LTD

DESIGNED BY : 陳明宗

DRAWN BY : 呂姿儀

CHECKED BY : 林軒逸

APPROVED BY : 錢明谷

TITLE : AP-CON AREA SERIES SPECIFICATION

DOCUMENT NO.

MES003702

REV

A0

6.4.4 Solderability

A lead wire termination shall be dipped for 2 ± 0.5 seconds in the flux of ethanol or isopropylalcohol solution ($25\pm 2\%$) of colophonium. Then that lead wire terminations shall be immersed to a solder (H60A, H60S or H63A) of 235 ± 5 °C and up to the point 1.5 to 2.0mm from the body and kept for 2 ± 0.5 seconds, and pulling it out. After this test, at least 95% of circumferential surface of the dipped portion of termination shall be covered with new solder.

6.4.5 Resistance to soldering heat

A Capacitor shall be inserted to a printed circuit board having a thickness of 1.6mm up to the point 1.5 to 2.0mm from the body. Then the lead wire termination shall be dipped for 5 to 10 seconds in the flux of ethanol solution ($25\pm 2\%$) of colophonium. And then the lead wire termination shall be immersed to the solder (H60A, H60S or H63A) of 260 ± 5 °C and up to the point of the Printed circuit board and kept for 10 ± 1 seconds, and pulling it out. After this test, characteristics shall meet the value in Table 12.

Table12 Soldering heat resistance

Characteristics	Performance
Capacitance change	Within $\pm 5\%$ of the value before test
$\tan\delta$	Not exceed than the value in Table 5
Leakage current	Not exceed than the value in Table 5
Visual	No remarkable abnormality

6.4.6 Resistance to solvent

A Capacitor shall be immersed for 30 ± 5 seconds in isopropylalcohol at 20 to 25 °C and then pull it out. After this test, marking and visual shall meet the requirement in Table 13.

Table 13 Solvent resistance

Characteristics	Performance
Marking	Easily readable
Appearance	Not appear any abnormality

THIS DRAWINGS AND SPECIFICATIONS ARE THE PROPERTY OF APAQ TECHNOLOGY CO. LTD AND SHALL NOT BE REPRODUCT OR USED AS THE BASIC FOR THE MANUFACTURE OR SALE OF APPARATUS OR DEVICES WITHOUT PERMISSION.



鈺邦科技股份有限公司

APAQ TECHNOLOGY CO., LTD

DESIGNED BY : 陳明宗

DRAWN BY : 呂姿儀

CHECKED BY : 林軒逸

APPROVED BY : 錢明谷

TITLE : AP-CON AREA SERIES SPECIFICATION

DOCUMENT NO.

MES003702

REV

A0

6.5 Environmental performance

6.5.1 Damp heat, steady state

A capacitor shall be subjected to a temperature of 60 ± 2 °C and relative humidity of 90 to 95% without voltage applied for a period of $1000+24/-0$ hours. Then that capacitor shall be taken out from the above condition to a temperature of 20 °C and it shall meet the characteristics in Table 14.

Table 14 Damp heat performance

Characteristics	Performance
Appearance	No significant damage
Capacitance change	$\leq \pm 20\%$ of the initial value
$\tan\delta$	$\leq 150\%$ of the initial specified value
ESR	$\leq 150\%$ of the initial specified value
Leakage current	\leq the initial specified value

6.5.2 Endurance

A capacitor shall be subjected to a temperature of 105 ± 2 °C with test voltage applied for a period of $2,000+72/-0$ hours and take out from the above condition to a temperature of 20 °C. After this test, that capacitor shall meet the characteristics in Table 15.

Besides, the applied voltage shall increase up from 0V to test voltage step by step (maximum 5 minutes), and the impedance of the source shall be equal to about $3\Omega/V$.

Table 15 Endurance performance

Characteristics	Performance
Appearance	No significant damage
Capacitance change	$\leq \pm 20\%$ of the initial value
$\tan\delta$	$\leq 150\%$ of the initial specified value
ESR	$\leq 150\%$ of the initial specified value
Leakage current	\leq the initial specified value

THIS DRAWINGS AND SPECIFICATIONS ARE THE PROPERTY OF APAQ TECHNOLOGY CO. LTD AND SHALL NOT BE REPRODUCT OR USED AS THE BASIC FOR THE MANUFACTURE OR SALE OF APPARATUS OR DEVICES WITHOUT PERMISSION.



鈺邦科技股份有限公司

APAQ TECHNOLOGY CO., LTD

DESIGNED BY : 陳明宗

DRAWN BY : 呂姿儀

CHECKED BY : 林軒逸

APPROVED BY : 錢明谷

TITLE : AP-CON AREA SERIES SPECIFICATION

DOCUMENT NO.

MES003702

REV

A0

6.5.3 Surge voltage

The following specifications in Table 16 shall be satisfied when the capacitors are restored to +20 °C after the surge voltage is applied at a cycle of 360 seconds which consists charge for 30±5 seconds through a protective resistor of 1kΩ and discharge for 330 seconds, for 1000 cycles at 105±2 °C.

Table 16 Surge voltage performance

Characteristics	Performance
Appearance	No significant damage
Capacitance change	≤ ±20% of the initial value
tanδ	≤ 150% of the initial specified value
ESR	≤ 150% of the initial specified value
Leakage current	≤ the initial specified value

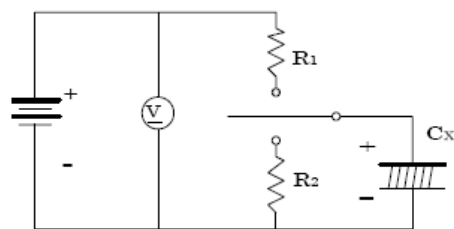

- Ⓟ :DC voltmeter
- R1 :Protective resistor 1kΩ
- R2 :Discharging resistor 1kΩ
- C_x :Capacitor under test

Fig. 5 Surge voltage circuit

6.5.4 Rapid temperature change

The characteristics of a capacitor kept under the temperature cycle indicated in Figure 6 for 5 cycles and followed the voltage treatment as described in section 6.2 shall meet the characteristics in Table 17.

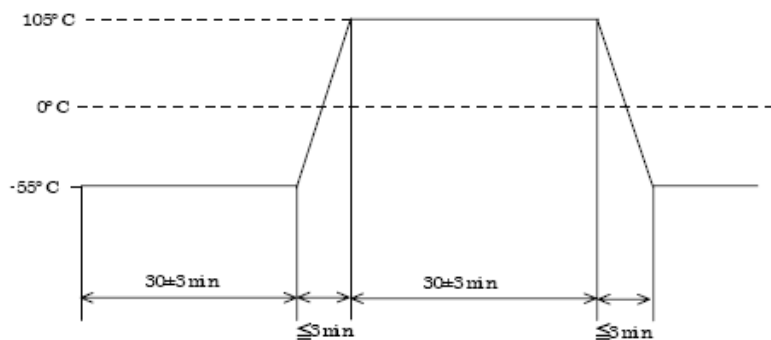

Fig. 6 Rapid temperature change profile

THIS DRAWINGS AND SPECIFICATIONS ARE THE PROPERTY OF APAQ TECHNOLOGY CO. LTD AND SHALL NOT BE REPRODUCT OR USED AS THE BASIC FOR THE MANUFACTURE OR SALE OF APPARATUS OR DEVICES WITHOUT PERMISSION.



鈺邦科技股份有限公司

APAQ TECHNOLOGY CO., LTD

DESIGNED BY : 陳明宗

DRAWN BY : 呂姿儀

CHECKED BY : 林軒逸

APPROVED BY : 錢明谷

TITLE : AP-CON AREA SERIES SPECIFICATION

DOCUMENT NO.

MES003702

REV

A0

Table 17 Rapid temperature change performance

Characteristics	Performance
Appearance	No significant damage
Capacitance change	$\leq \pm 10\%$ of the initial value
$\tan\delta$	\leq the initial specified value
ESR	\leq the initial specified value
Leakage current	\leq the initial specified value

7. Instructions of Capacitors

7.1 Cautions on use of Capacitor

7.1.1 Polarity

Solid electrolytic capacitors are polarized capacitors. Use capacitors after verifying their positive and negative polarities. If these capacitors are installed in the reverse polarity, its life may shorten because of increasing leakage current or short circuit.

7.1.2 Types of circuits in which capacitors are prohibited from being used AREA series may be heated by soldering to increase in its leakage current slightly. This may have some influence on the characteristics capacitors in the following circuits.

- (1) Time constant circuit
- (2) Coupling circuit
- (3) High impedance voltage holding circuit
- (4) Connection of two or more capacitors in series for higher withstand voltage.

7.1.3 Over voltage

If AREA series is applied a voltage higher than the rated voltage for an instantaneous period, it may be defected due to short circuit. Note that the voltage over the rated voltage must not be applied to capacitors.

7.1.4 Repeat of rapid charging and discharging

If AREA series is used in a rapid charging and discharging circuit or receive the flow of excess rush current, its life may shorten by large leakage current or short circuit. The charging and discharging current through AREA series should be less than 10A.

7.1.5 Soldering

Capacitors should be soldered under the soldering conditions defined in the delivery specifications. Some improper soldering condition may cause the leakage current of capacitors to increase or other parameters to change.

THIS DRAWINGS AND SPECIFICATIONS ARE THE PROPERTY OF APAQ TECHNOLOGY CO. LTD AND SHALL NOT BE REPRODUCT OR USED AS THE BASIC FOR THE MANUFACTURE OR SALE OF APPARATUS OR DEVICES WITHOUT PERMISSION.



鈺邦科技股份有限公司

APAQ TECHNOLOGY CO., LTD

DESIGNED BY : 陳明宗

DRAWN BY : 呂姿儀

CHECKED BY : 林軒逸

APPROVED BY : 錢明谷

TITLE : AP-CON AREA SERIES SPECIFICATION

DOCUMENT NO.

MES003702

REV

A0

7.1.6 Use of capacitors for industrial equipment

When capacitors are used for industrial equipment, the circuits should be designed to have sufficient margins in the ratings of capacitors including capacitance and impedance. Without sufficient margins in the characteristics, the reliability of the capacitors may be reduced by their shorter life. Always contact us if you want to use capacitors for equipment affecting human lives such as space, aviation, atomic power, and medical devices. Never use capacitors for the used without our prior approval.

7.2 Notes on circuit designs for capacitors

7.2.1 Rating and performance

Use capacitors within the rating and performance ranges defined in the brochures and delivery specification of capacitors after checking the operating and installation environments.

7.2.2 Operating temperature

If AREA series is used at a temperature higher than the upper specified temperature (105°C), its life may be remarkably shortened or the leakage current may increase to cause defective.

7.2.3 Ripple current

Never make current larger than the rated ripple current through AREA series. If excess ripple current flows through AREA series, internal heat may be generated largely to make its life shortened or cause it to be defected due to short circuit.

7.2.4 Leakage current

Depending on the soldering conditions, the leakage current of AREA series may increase slightly. The application of DC voltage enables the capacitors to be repaired by itself. This leads the leakage current to be smaller gradually. The leakage current can be reduced fast if the DC voltage, which is less than the rating voltage, is applied at the temperature close to the upper specified temperature.

7.2.5 Applied voltage

- (1) To secure the reliability of capacitors, it is recommended that the voltage applied to them should be less than 80% of the rated voltage.
- (2) The peak value of the ripple voltage superimposed with the DC voltage should be less than the rated voltage.

THIS DRAWINGS AND SPECIFICATIONS ARE THE PROPERTY OF APAQ TECHNOLOGY CO. LTD AND SHALL NOT BE REPRODUCT OR USED AS THE BASIC FOR THE MANUFACTURE OR SALE OF APPARATUS OR DEVICES WITHOUT PERMISSION.		 鈺邦科技股份有限公司 APAQ TECHNOLOGY CO., LTD	
DESIGNED BY : 陳明宗	DRAWN BY : 呂姿儀	CHECKED BY : 林軒逸	APPROVED BY : 錢明谷
TITLE : AP-CON AREA SERIES SPECIFICATION		DOCUMENT NO.	MES003702
			REV A0

7.2.6 Failure mode

AREA series contains a conductive polymer as material of cathode electrode. Therefore, like other solid electrolyte capacitors, the life ends mostly due to random failure mode, mainly short circuit. If a current continuously flow through the capacitor due to short circuit, the capacitor would be overheated higher than 300°C and then aluminum case of the capacitor would be removed by increasing internal pressure due to the vaporization of materials.

7.2.7 Insulation

- (1) Plastic coated case of capacitors is not secured to insulate. Do not use capacitors in areas requiring insulation.
- (2) Isolate the case of AREA series from the positive and negative terminals and adjacent circuit patterns.

7.2.8 Design of printed circuit board

Take note on the following subjects when capacitors are installed on printed circuit boards:

- (1) Verify that the lead spacing fit hole pitches on printed circuit board.
- (2) Do not place heating components on boards to be close to capacitors or in the backside of them.
- (3) If capacitors are mounted on a double-sided PC board, design the board so that extra or through holes may not be opened below them.

7.2.9 Parallel connection

If AREA series is connected with another type of a capacitor in parallel, larger ripple current may flow through one of capacitors. Take the current balance among them into account in circuit designs.

7.2.10 Using temperature and frequency

The electric characteristics of capacitors depend on the variations of the ambient temperature and frequency. Check the variations in designing circuits.

7.3 Notes on installation of capacitors

7.3.1 Notes on pre-installation of capacitors

- (1) Do not reuse capacitors installed in a unit with the power supply turned on for another unit. No used capacitors shall be reused excluding those removed to measure their electric characteristics in periodical inspection.
- (2) If AREA series stored for a long period may often increase in its leakage current, connect a resistor of approximately 1kΩ to the capacitors for voltage treatment.

THIS DRAWINGS AND SPECIFICATIONS ARE THE PROPERTY OF APAQ TECHNOLOGY CO. LTD AND SHALL NOT BE REPRODUCT OR USED AS THE BASIC FOR THE MANUFACTURE OR SALE OF APPARATUS OR DEVICES WITHOUT PERMISSION.		 鈺邦科技股份有限公司 APAQ TECHNOLOGY CO., LTD	
DESIGNED BY : 陳明宗	DRAWN BY : 呂姿儀	CHECKED BY : 林軒逸	APPROVED BY : 錢明谷
TITLE : AP-CON AREA SERIES SPECIFICATION		DOCUMENT NO.	MES003702
			REV A0

7.3.2 Notes at installation of capacitors

- (1) Install capacitors in a unit after confirming that their ratings (rated capacitance and rated voltages) meet the conditions of the unit.
- (2) Install capacitors in the correct polarities.
- (3) Take care not to drop capacitors on floors. Do not use capacitors dropped on floors.
- (4) Do not deform capacitors to install them in units.
- (5) Install AREA series on a printed circuit board after confirming that its lead pitch is equivalent to the corresponding hole pitch.
- (6) At the picking, mounting, and locating by an automatic inserter or the cutting of the leads of AREA series by an automatic mouter, some stress may be applied to the AREA series. Take note on the shock.
- (7) Do not apply any excess force with the terminals of capacitors.

7.3.3 Heating

In preheating or heating for adhesion and fixing of other electronic components, the temperature put to capacitors should be less than 120°C. The total heating period should be shorter the 90 seconds.

7.3.4 Soldering by soldering iron

- (1) Capacitors should be soldered under the conditions as follows:
The iron tip at the temperature of 400±10°C or less may be put to each lead of AREA series for shorter than 3+1 seconds.
- (2) The lead wire terminations of capacitors may be required to be processed because the distance between the terminals is not equivalent to that of corresponding holes on the printed circuit board. Process the terminations so that no stress may be applied to the capacitors itself before soldering.
- (3) Do not make the tip of a soldering iron be in contact with capacitors themselves.
- (4) The leakage current of soldered capacitors may increase slightly depending on several conditions including pre-heating, soldering temperature and period, and board material and thickness. However, the leakage current decreases gradually by the self-repair characteristic of capacitors when they are used with voltage application.

7.3.5 Flow soldering

- (1) Do not dip capacitors themselves into melted solder in soldering. Only provide soldering for the board surface in the backside of the surface on which the capacitors are mount

THIS DRAWINGS AND SPECIFICATIONS ARE THE PROPERTY OF APAQ TECHNOLOGY CO. LTD AND SHALL NOT BE REPRODUCT OR USED AS THE BASIC FOR THE MANUFACTURE OR SALE OF APPARATUS OR DEVICES WITHOUT PERMISSION.		 鈺邦科技股份有限公司 APAQ TECHNOLOGY CO., LTD	
DESIGNED BY : 陳明宗	DRAWN BY : 呂姿儀	CHECKED BY : 林軒逸	APPROVED BY : 錢明谷
TITLE : AP-CON AREA SERIES SPECIFICATION	DOCUMENT NO.	MES003702	REV
			A0

- (2) Solder capacitors under the soldering conditions as follows.
 - (a) Pre-heat condition: atmosphere temperature 120°C or less for up to 90 seconds
 - (b) Soldering condition: solder temperature 260°C or less for up to 10 seconds.
- (3) Note that flux may not adhere to any substances except lead wires.
- (4) Do not make any other components fallen at capacitors in soldering.

7.3.6 Handling of capacitors after soldering

- (1) Do not incline, bend, and twist capacitors.
- (2) Do not grab capacitors as a handle to carry the printed circuit board.
- (3) Do not hit objects against capacitors. When printed circuit boards are piled up, do not make them and/or other components be in contact with capacitors.
- (4) Do not drop printed circuit boards with capacitors installed.

7.3.7 Cleaning of printed circuit board

As long as the cleaning agents prescribed in the catalogue or the specification sheets are used, the cleaning does not give the capacitors any damage. For CFCs substitutions and other cleaning agents, consult us before actual use.

7.3.8 Fixing and coating materials

Contact us for fixing and coating materials appropriate for capacitors and their heat curing conditions.

7.4 Notes on use of capacitors in unit

- (1) Never make your fingers contact with the lead wire terminations of capacitors.
- (2) Do not make lead wire terminations of AREA series to be in contact with each other through a conductor. Do not put conductive liquid such as acid and alkali solutions on capacitors.
- (3) Confirm that the unit including capacitors is placed in proper conditions. Do not place the unit in the following areas:
 - (a) Area in which they are directly exposed to water, brine, or oil or in condensation status.
 - (b) Area filled with poisonous gases including hydrogen sulfide, sulfurous acid, nitrous acid, chlorine and ammonia.
 - (c) Area to which ultraviolet and/or radial rays are radiated
- (4) Provide aging for a unit containing capacitors within the period defined for them.
- (5) It is recommended to use a unit containing capacitors in the normal temperature range of 15°C to 35°C and the normal humidity range of 75% or less.

THIS DRAWINGS AND SPECIFICATIONS ARE THE PROPERTY OF APAQ TECHNOLOGY CO. LTD AND SHALL NOT BE REPRODUCT OR USED AS THE BASIC FOR THE MANUFACTURE OR SALE OF APPARATUS OR DEVICES WITHOUT PERMISSION.		 鈺邦科技股份有限公司 APAQ TECHNOLOGY CO., LTD		
DESIGNED BY : 陳明宗	DRAWN BY : 呂姿儀	CHECKED BY : 林軒逸	APPROVED BY : 錢明谷	
TITLE : AP-CON AREA SERIES SPECIFICATION		DOCUMENT NO.	MES003702	REV
				A0

7.5 Action at emergency

- (1) At the occurrence of short circuit in AREA series, some heat is generated from it if the short-current rather small. If the short current exceeds the above value, the capacitors are heated excessively. If so, turn off the power of the unit without your face and hands being close to the capacitors.
- (2) Never lick the electrolyte of conductive polymer in capacitors. If the electrolyte is put on your skin, wash it away carefully with soap.
- (3) The materials of seal rubber used for capacitors are flammable. If an adjacent component is burned, seal rubber of the capacitors may burn. Take sufficient note on the installation procedures and locations of capacitors and the pattern designs of printed circuit boards.

7.6 Storage

- (1) Store capacitors in an area in the temperature range between 15°C to 35°C and the relative humidity of 75% or less without direct sunshine. In addition, store them in the package states if possible.
- (2) Capacitors should be stored for up to three years to maintain their good soldering features and characteristics.
- (3) Capacitors are recommended that you shall open the bag just before use and capacitors shall be used up. If some quantity was not need, please seal it with adhesive tape.
- (4) Never store capacitors in any area in which they are directly exposed to water, brine, or oil or in condensation status.
- (5) Never store capacitors in any area filled with poisonous gases including hydrogen sulfide, sulfurous acid, nitrous acid, chlorine, and ammonia.
- (6) Never store capacitors in any area to which ultraviolet and/or radial rays are radiated.

7.7 Exhaustion of capacitors

Capacitors are composed of organic compounds, resins and metals. Request an industrial dispose company to dispose of used capacitors.

THIS DRAWINGS AND SPECIFICATIONS ARE THE PROPERTY OF APAQ TECHNOLOGY CO. LTD AND SHALL NOT BE REPRODUCED OR USED AS THE BASIC FOR THE MANUFACTURE OR SALE OF APPARATUS OR DEVICES WITHOUT PERMISSION.



鈺邦科技股份有限公司

APAQ TECHNOLOGY CO., LTD

DESIGNED BY : 陳明宗

DRAWN BY : 呂姿儀

CHECKED BY : 林軒逸

APPROVED BY : 錢明谷

TITLE : AP-CON AREA SERIES SPECIFICATION

DOCUMENT NO.

MES003702

REV

A0

8. Export Trade Control Ordinance

Item 41-4 in Section 2 of Appendix Table 1 (Section 49 in Chapter 1 of MITI' s Ordinance) and Item 7 in Section 7 of Appendix Table 1 (Section 6 in Chapter 6 of MITI' s Ordinance) state export regulations on pulse use capacitors (750V or higher) and high voltage use capacitors(5,000V or higher).

However, aluminum electrolytic capacitors are less than 750V in their voltage range, so that the regulations do not apply to the aluminum electrolytic capacitors.

9. Package

The capacitors should be packed in the following quantities listed in Table 18.

Table 18 Quantity of package

Case size	PE bag	inner box	outer box
$\phi 4$	1,000 PCS	24 bags (24,000 PCS)	5 inner boxes (120,000 PCS)
$\phi 5$	500 PCS	8 bags (4,000 PCS)	5 inner boxes (20,000 PCS)
$\phi 6*6$	500 PCS	12 bags (6,000 PCS)	5 inner boxes (30,000 PCS)
$\phi 6*9$	500 PCS	8 bags (4,000 PCS)	5 inner boxes (20,000 PCS)
$\phi 6*11$	500 PCS	6 bags (3,000 PCS)	5 inner boxes (15,000 PCS)
$\phi 8*9$	500 PCS	6 bags (3,000 PCS)	5 inner boxes (15,000 PCS)
$\phi 8*12$	500 PCS	4 bags (2,000 PCS)	5 inner boxes (10,000 PCS)
$\phi 10$	500 PCS	4 bags (2,000 PCS)	5 inner boxes (10,000 PCS)

THIS DRAWINGS AND SPECIFICATIONS ARE THE PROPERTY OF APAQ TECHNOLOGY CO. LTD AND SHALL NOT BE REPRODUCT OR USED AS THE BASIC FOR THE MANUFACTURE OR SALE OF APPARATUS OR DEVICES WITHOUT PERMISSION.



鈺邦科技股份有限公司

APAQ TECHNOLOGY CO., LTD

DESIGNED BY : 陳明宗

DRAWN BY : 呂姿儀

CHECKED BY : 林軒逸

APPROVED BY : 錢明谷

TITLE : AP-CON AREA SERIES SPECIFICATION

DOCUMENT NO.

MES003702

REV

A0