

SE15N50FRA

**N-Channel Enhancement-Mode MOSFET with FR**

Revision: A

**General Description**

High Density Cell Design For Ultra Low On-Resistance Fully Characterized Avalanche Voltage and Current Improved Shoot-Through FOM

- Simple Drive Requirement
- Small Package Outline
- Surface Mount Device

**Features**

For a single MOSFET

- $V_{DS} = 500V$
- $R_{DS(ON)} = 0.43\Omega @ V_{GS}=10V$

**Pin configurations**

See Diagram below

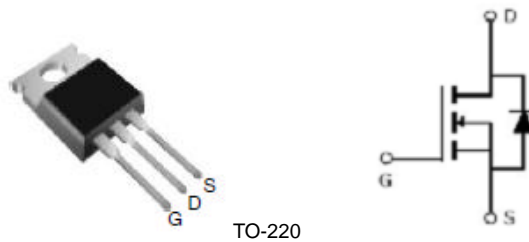

**Absolute Maximum Ratings**

Parameter		Symbol	Rating	Units
Drain-Source Voltage		$V_{DS}$	500	V
Gate-Source Voltage		$V_{GS}$	$\pm 30$	V
Drain Current	Continuous	$I_D$	15	A
	Pulsed		60	
Avalanche Energy, Single Pulse		$E_{AS}$	160	mJ
Avalanche Energy, Repetitive		$E_{AR}$	0.3	mJ
Continuous Diode Forward Current		$I_S$	8.7	A
Diode Pulse Current		$I_{S, Pulse}$	26.1	A
Total Power Dissipation @TC=25°C		$P_D$	83	W
Operating Junction Temperature Range		$T_J$	-55 to 150	°C

**Thermal Resistance**

Symbol	Parameter	Min	Max	Units
$R_{\theta JC}$	Junction to Case		4.0	°C/W
$R_{\theta JA}$	Junction to Ambient (t ≤ 10s)		80	°C/W

## SE15N50FRA

Electrical Characteristics (T <sub>J</sub> =25°C unless otherwise noted)						
Symbol	Parameter	Test Conditions	Min	Typ	Max	Units
<b>OFF CHARACTERISTICS</b>						
B <sub>V</sub> DSS	Drain-Source Breakdown Voltage	I <sub>D</sub> =250μA, V <sub>GS</sub> =0V	500			V
I <sub>DSS</sub>	Drain to Source Leakage Current	V <sub>DS</sub> =500V, V <sub>GS</sub> =0V			1	nA
I <sub>GSS</sub>	Gate-Body Leakage Current	V <sub>GS</sub> =20V			100	nA
V <sub>GS(th)</sub>	Gate Threshold Voltage	V <sub>DS</sub> = V <sub>GS</sub> , I <sub>D</sub> =250μA	3.0	3.5	4.0	V
R <sub>DS(ON)</sub>	Static Drain-Source On-Resistance	V <sub>GS</sub> =10V, I <sub>D</sub> =7.5A		0.43	0.50	Ω
<b>DYNAMIC PARAMETERS</b>						
C <sub>iss</sub>	Input Capacitance	V <sub>GS</sub> =0V, V <sub>DS</sub> =25V, f=1MHz		739		pF
C <sub>oss</sub>	Output Capacitance			58		pF
C <sub>rss</sub>	Reverse Transfer Capacitance			40		pF
<b>SWITCHING PARAMETERS</b>						
Q <sub>g</sub>	Total Gate Charge <sup>2</sup>	V <sub>GS</sub> =10V, V <sub>DS</sub> =15V, I <sub>D</sub> =15A		20		nC
Q <sub>gs</sub>	Gate Source Charge			4.3		nC
Q <sub>gd</sub>	Gate Drain Charge			7.6		nC
t <sub>d(on)</sub>	Turn-On Delay Time	V <sub>GS</sub> =10V, V <sub>DS</sub> =50V, R <sub>GEN</sub> =18Ω I <sub>D</sub> =9.2A		11		ns
t <sub>d(off)</sub>	Turn-Off Delay Time			29		ns
t <sub>d(r)</sub>	Turn-On Rise Time			31		ns
t <sub>d(f)</sub>	Turn-Off Fall Time			28		ns
<b>Source-Drain Ratings and Characteristics</b>						
V <sub>SD</sub>	Diode Forward Voltage	V <sub>GS</sub> =0V, I <sub>S</sub> =15A		0.89	1.1	V
t <sub>rr</sub>	Reverse Recovery Time	V <sub>R</sub> =400V, I <sub>F</sub> =15A dI <sub>F</sub> /dt=100A/μs		63		ns
Q <sub>rr</sub>	Reverse Recovery Charge			390		nC
I <sub>rrm</sub>	Peak Reverse Recovery Current			7.7		A

Typical Characteristics

Figure 3: Power Dissipation

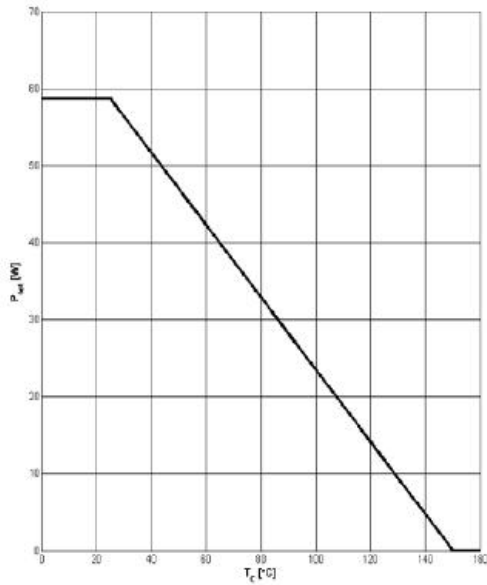

$P_{tot} = f(T_c)$

Figure 4: Max. Transient Thermal Impedance

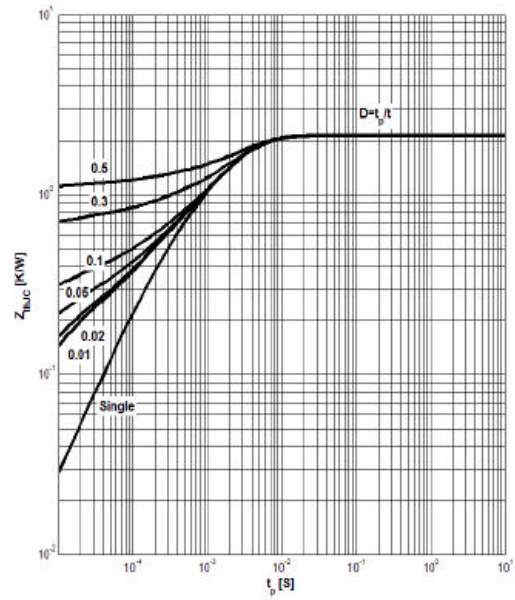

$Z_{thJC} = f(t_p)$ ; parameter:  $D = t_p/T$

Figure 5: Safe Operating Area

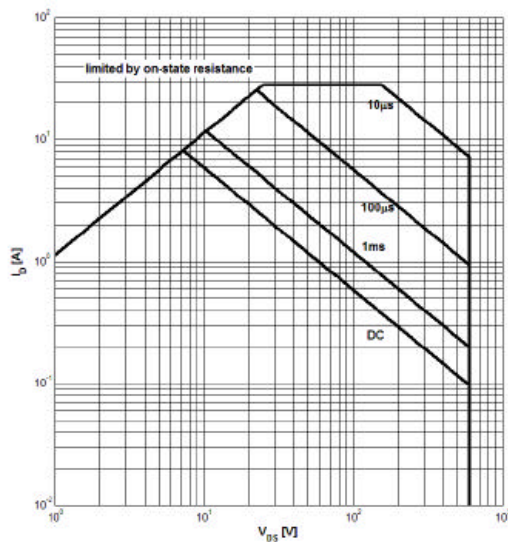

$I_D = f(V_{DS})$ ;  $T_c = 25^{\circ}C$ ;  $V_{GS} > 7V$ ; parameter  $t_p$

Figure 6: Safe Operating Area

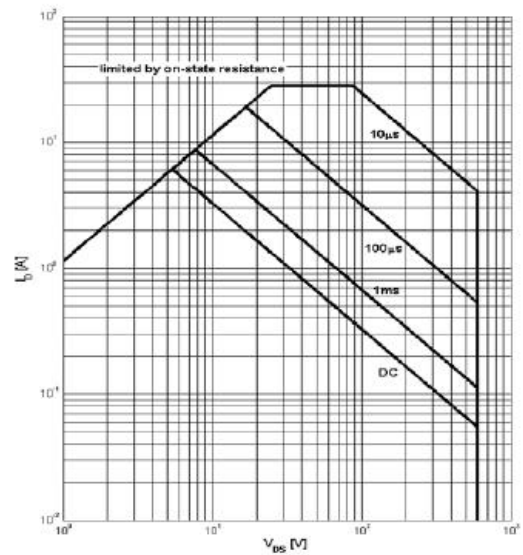

$I_D = f(V_{DS})$ ;  $T_c = 80^{\circ}C$ ;  $V_{GS} > 7V$ ; parameter  $t_p$

Figure 7: Typ. Output Characteristics

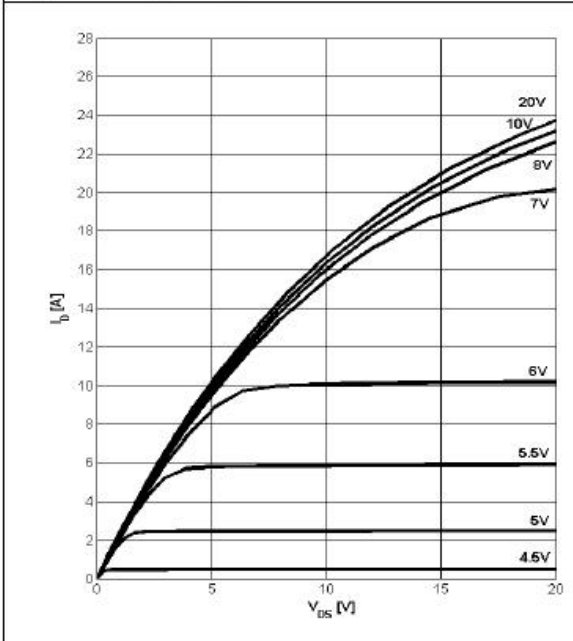

$I_D = f(V_{DS})$ ;  $T_j = 25^\circ\text{C}$ ; parameter:  $V_{GS}$

Figure 8: Typ. Output Characteristics

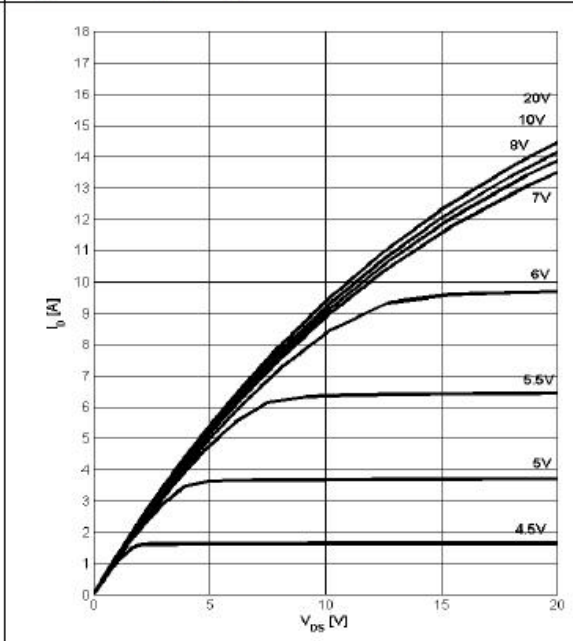

$I_D = f(V_{DS})$ ;  $T_j = 125^\circ\text{C}$ ; parameter:  $V_{GS}$

Figure 9: Typ. Drain-Source On-State Resistance

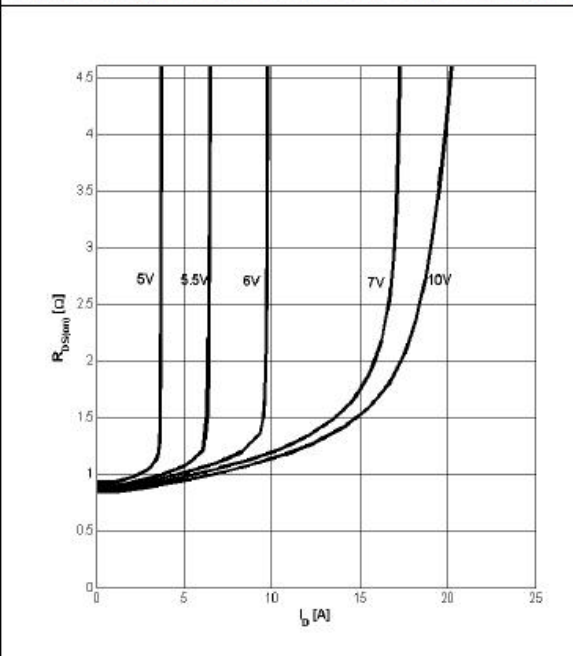

$R_{DS(on)} = f(I_D)$ ;  $T_j = 125^\circ\text{C}$ ; parameter:  $V_{GS}$

Figure 10: Typ. Drain-Source On-State Resistance

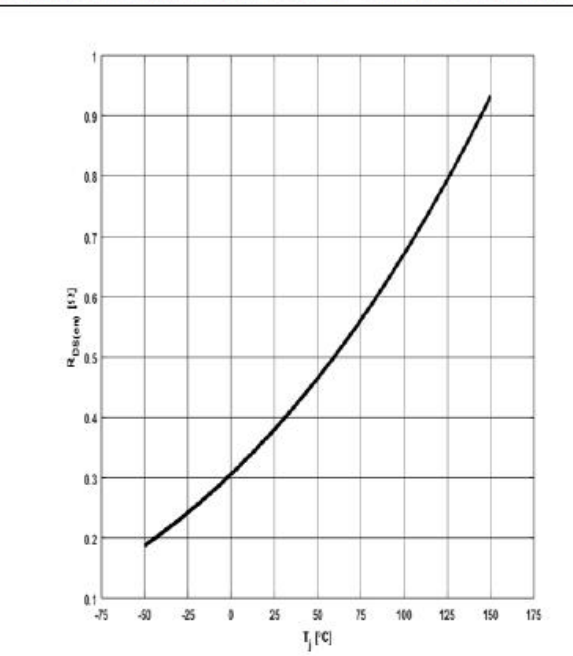

$R_{DS(on)} = f(T_j)$ ;  $I_D = 4.5\text{A}$ ;  $V_{GS} = 10\text{V}$

Figure 11: Typ. Transfer Characteristics

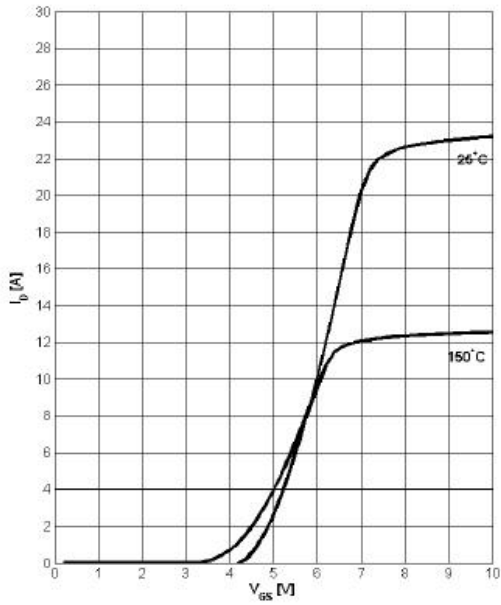

$I_D = f(V_{GS}); V_{DS} = 20V$

Figure 12: Typ. Gate Charge

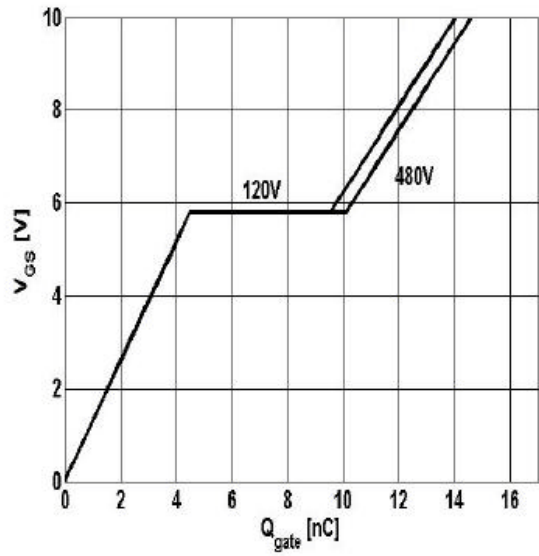

$V_{GS} = f(Q_{gate}), I_D = 4.5A$  pulsed

Figure 13: Drain-Source Breakdown Voltage

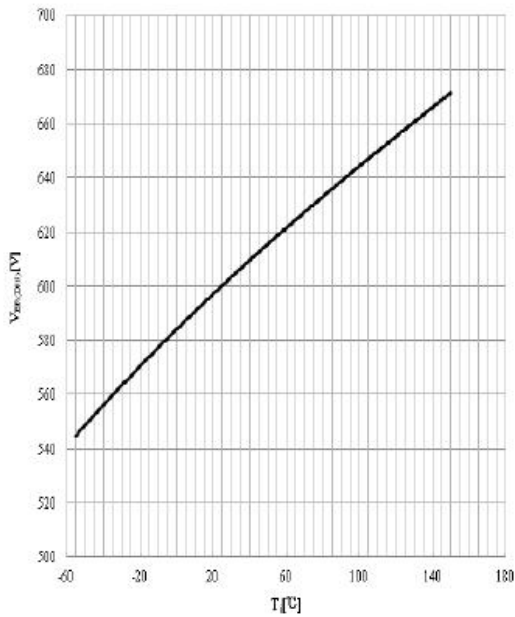

$V_{BR(DSS)} = f(T_j); I_D = 1mA$

Figure 14: Forward Characteristics of Reverse Diode

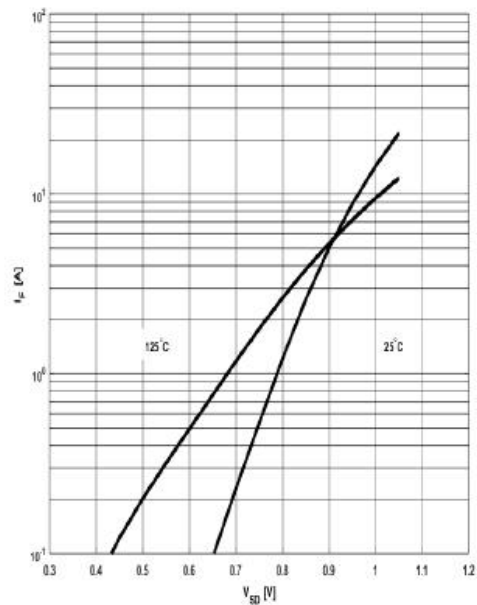

$I_F = f(V_{SD});$  parameter:  $T_j$

# SE15N50FRA

## Package Outline Dimension

TO-220

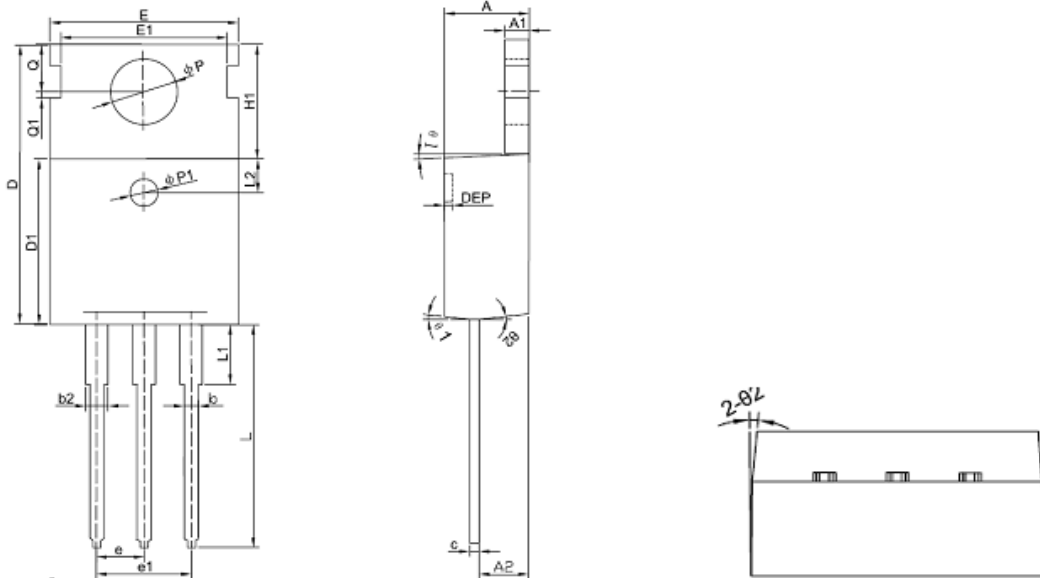

Symbol	Dimension In Millimeters			Dimension In Inches		
	Min	Nom	Max	Min	Nom	Max
A	4.400	4.550	4.700	0.173	0.179	0.185
A1	1.270	1.300	1.330	0.050	0.051	0.052
A2	2.590	2.690	2.790	0.102	0.106	0.110
b	0.770	-	0.900	0.030	-	0.035
b2	1.230	-	1.360	0.048	-	0.054
c	0.480	0.500	0.520	0.019	0.020	0.020
D	15.100	15.400	15.700	-	0.606	-
D1	9.000	9.100	9.200	0.354	0.358	0.362
DEP	0.050	0.285	0.520	0.002	0.011	0.020
E	10.060	10.160	10.260	0.396	0.400	0.404
E1	-	8.700	-	-	0.343	-
ΦP1	1.400	1.500	1.600	0.055	0.059	0.063
e	2.54BSC			0.1BSC		
e1	5.08BSC			0.2BSC		
H1	6.100	6.300	6.500	0.240	0.248	0.256
L	12.750	12.960	13.170	0.502	0.510	0.519
L1	-	-	3.950	-	-	0.156
L2	1.85REF			0.073REF		
ΦP	3.570	3.600	3.630	0.141	0.142	0.143
Q	2.730	2.800	2.870	0.107	0.110	0.113
Q1	-	0.200	-	-	0.008	-
θ1	5 <sup>0</sup>	7 <sup>0</sup>	9 <sup>0</sup>	5 <sup>0</sup>	7 <sup>0</sup>	9 <sup>0</sup>
θ2	1 <sup>0</sup>	3 <sup>0</sup>	5 <sup>0</sup>	1 <sup>0</sup>	3 <sup>0</sup>	5 <sup>0</sup>

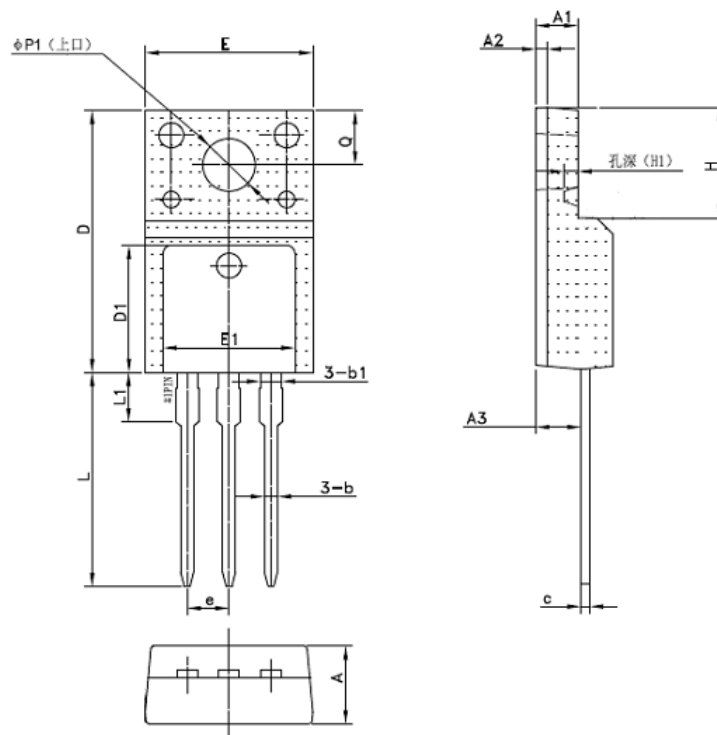

Symbol	Dimensions(mm)		
	Min.	Typ.	Max.
A	4.50	4.70	4.90
A1	2.44	2.54	2.64
A2	0.60	0.70	0.80
A3	2.56	2.76	2.96
b	0.70	0.80	0.95
b1	-	1.28	-
c	0.45	0.50	0.65
D	15.67	15.87	16.07
D1	-	7.70	-
E	9.96	10.16	10.36
E1	-	8.00	-
e	2.54(BSC)		
H	6.50	6.70	6.90
(H1)	-	(0.81)	-
L	12.48	12.98	13.20
L1	-	2.93	-
$\phi P1$	2.98	3.18	3.38
Q	3.10	3.30	3.50

## TO-252

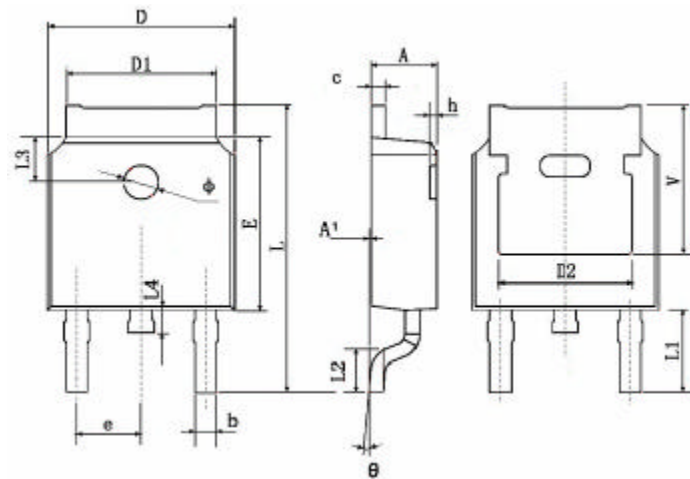

Symbol	Dimensions In Millimeters		Dimensions In Inches	
	Min.	Max.	Min.	Max.
A	2.200	2.400	0.087	0.094
A1	0.000	0.127	0.000	0.005
b	0.660	0.860	0.026	0.034
c	0.460	0.580	0.018	0.023
D	6.500	6.700	0.256	0.264
D1	5.100	5.460	0.201	0.215
D2	0.483 TYP.		0.190 TYP.	
E	6.000	6.200	0.236	0.244
e	2.186	2.386	0.086	0.094
L	9.800	10.400	0.386	0.409
L1	2.900 TYP.		0.114 TYP.	
L2	1.400	1.700	0.055	0.067
L3	1.600 TYP.		0.063 TYP.	
L4	0.600	1.000	0.024	0.039
$\Phi$	1.100	1.300	0.043	0.051
$\theta$	0°	8°	0°	8°
h	0.000	0.300	0.000	0.012
V	5.350 TYP.		0.211 TYP.	