

SPECIFICATIONS:

1. ELECTRICAL CHARACTERISTICS:
 1-1. CONTACT RESISTANCE: 30mΩ MAX.
 1-2. DIELECTRIC WITHSTANDING VOLTAGE: 100V AC FOR ONE MINUTE.
 1-3. INSULATION RESISTANCE: 100MΩ MIN. MEASURED BY 500 VDC
 2. MECHANICAL CHARACTERISTICS:
 2-1. INSERTION FORCE :0.5-2.0Kgf(REF.)
 2-2. WITHDRAWAL FORCE :0.8-2.0Kgf(REF.)
 3. LIFE TEST: 10,000 CYCLES.
 4. TO CONFORM TO THE KRCONN HAZARDOUS SUBSTANCE FREE SPEC.

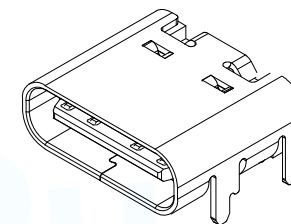

TYPEC-304A-ACP16W	白色
TYPEC-304A-ACP16G	绿色
TYPEC-304A-ACP16L	蓝色
TYPEC-304A-ACP16O	橙色
Part No.:	Color

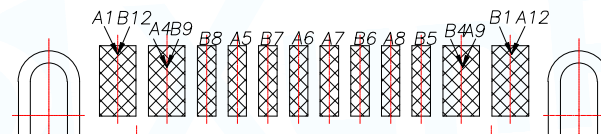
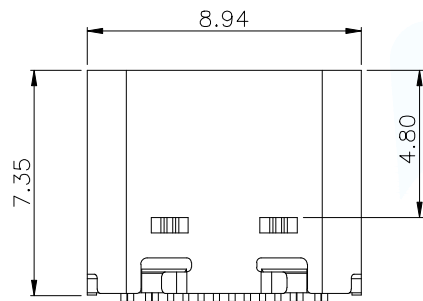

A1	GND	B12	GND
A4	VBUS	B9	VBUS
A5	CC1	B8	SBU2
A6	DP1	B7	DN2
A7	DN1	B6	DP2
A8	SBU1	B5	CC2
A9	VBUS	B4	VBUS
A12	GND	B1	GND
PIN	SIGNAL NAME	PIN	SIGNAL NAME

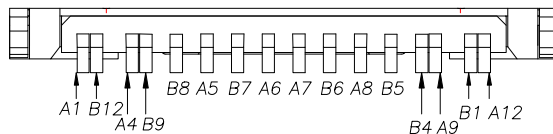
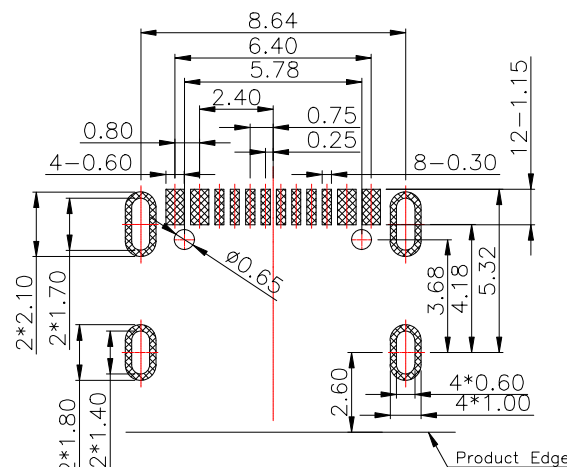
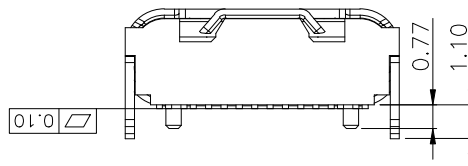

RECOMMENDED P.C.B. LAYOUT
 TOLERANCE UNSPECIFIED ±0.05mm

6	SHELL	STAINLESS STEEL	NI Plated	1PCS
5	SHIELDING PLATE	STAINLESS STEEL	---	1PCS
4	MD	HIGH TEMPERATURE PLASTIC	BLACK	1PCS
3	CONTACT	COPPER ALLOY	Au/Ni Plated	1SET
2	CONTACT	COPPER ALLOY	Au/Ni Plated	1SET
1	HOUSING	HIGH TEMPERATURE PLASTIC	BLACK	1PCS
NO.	DESCRIPTION	MATERIAL	REMARKS	QTY

MANUFACTURE DWG

东莞市讯普电子科技有限公司
 DongGuan XunPu Electronics Co.,Ltd



TITLE: USB TYPE-C 16PIN 母座
 L=7.35

UNLESS OTHERWISE SPECIFIED TOLERANCES	
DECIMALS:	ANGLES:
X.:±0.50	X*.:±2.0°
X.X:±0.20	X.X*.:±1.0°
X.XX:±0.10	

PAR	TYPEC-304A-ACP16X
DWN	
CHKD	
APVD	
SCALE1:1	UNIT:MM
SIZE:A4	SHEET:1F1
	REV:A

CUSTOMER COPY

NOTES

1. 每卷包装数量:1000PCS/每卷
2. 卷带包装方式:

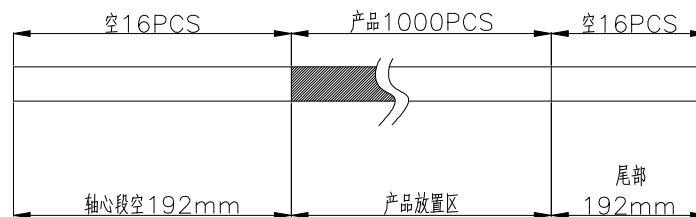

3. 每箱包装数量:10000PCS/箱
4. 重量 :
 - 4.1 净重 : Kg
 - 4.2 毛重 : Kg

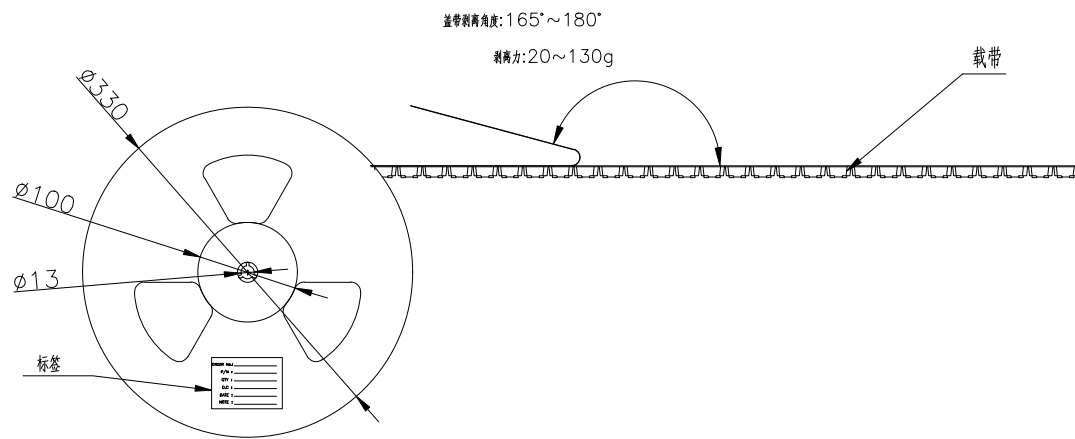
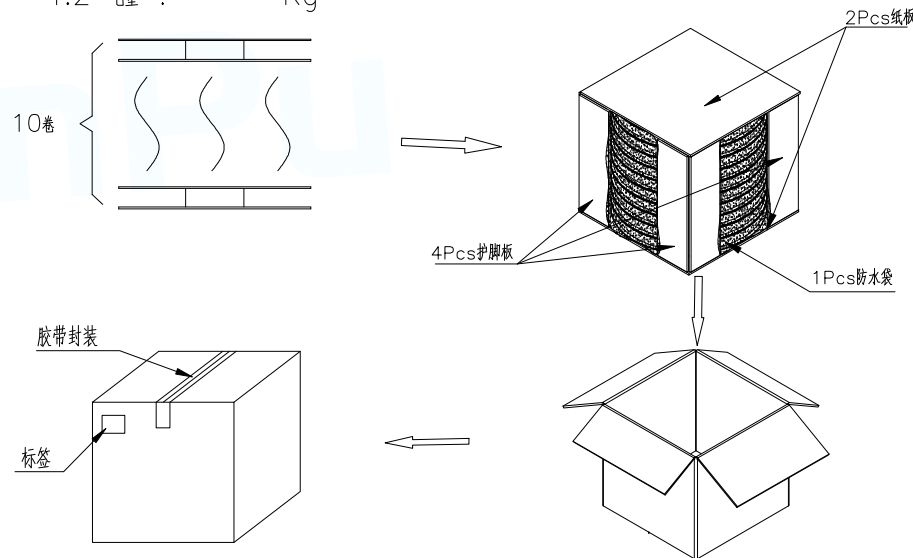

MANUFACTURE DWG		 东莞市讯普电子科技有限公司 DongGuan XunPu Electronics Co.,Ltd		
UNLESS OTHERWISE SPECIFIED TOLERANCES			TITLE: USB TYPE-C 16PIN 插座 L=7.35	
DECIMALS:	ANGLES:		PAR TYPEC-304A-ACP16X	
X.:±0.50	X'.:±2.0"		DWN	
X.X:±0.30	X.X'.:±1.0"		CHKD	
X.XX:±0.10		APVD		
CUSTOMER COPY		SCALE1:1	UNIT:MM	
		SIZE:A4	UNIT:MM	
		SHEET:1F1	REV:A	