

RoHS

CAD GENERATED DRAWING. DON'T CHANGE BY HAND.

REV.	ECN. NO.	APPD.

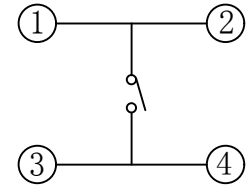
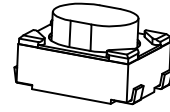
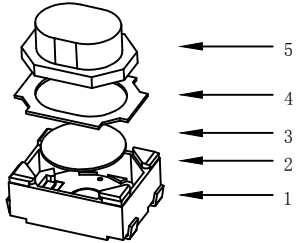

CIRCUIT DIAGRAM

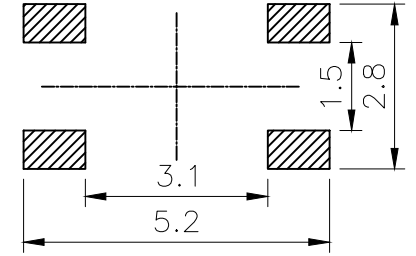
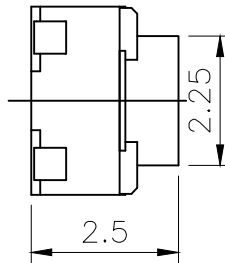
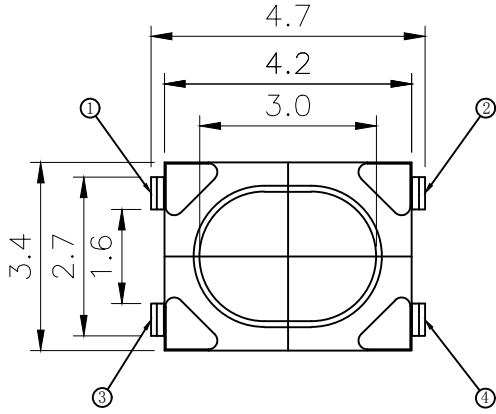

PCB. WELDING DRAWING

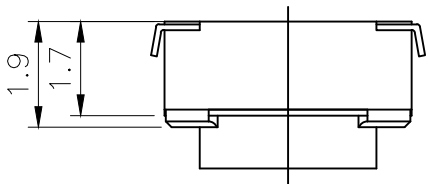

Specification

Rate voltage.current	50mA DC12V
Contact resistance	≤100mΩ
Operating force	400±50gf
Travel	0.20±0.10mm
Insulated resistance	≥100MΩ
Dielectric strength	≥250VAC/1min
Life cycle	≥100000次

ITEM	PART NAME	Q' TY	MATERIAL	FINSH/COLOR
5	Button	1	PPA	White
4	Cover	1	Phosphor copper	Copper tin plating
3	Shrapnel	1	Stainless steel	Silver
2	Housing	1	LCP	White
1	Cards	1	Phosphor copper	Silver

X. ±0.50	X. ° ±2°	UNITS mm		深圳市怡远科技有限公司 SHENZHEN YIYUAN TECHNOLOGY CO.,LTD
.X ±0.30	.X° ±1°			
.XX ±0.10	.XX° ±0.5°	MAT'L	PART NO. YTS-A016-3	TITLE: TACTILE SWITCH
.XXX ±0.05		FINISH	APPD: ROGER	DWG NO.: YTS-A016-3
THESE DRAWINGS AND SPECIFICATIONS ARE THE PROPERTY OF YIYUAN TECHNOLOGY CO.,LTD AND SHALL NOT BE REPRODUCED, COPIED OR USED IN ANY MANNER WITHOUT THE PRIOR WRITTEN CONSENT OF YIYUAN TECHNOLOGY CO.,LTD			CHKD: ROC	
			Q' TY	