

N-Channel Enhancement Mode Power MOSFET

Description

The JSM2622 uses advanced trench technology to provide excellent $R_{DS(ON)}$, low gate charge and operation with gate voltages as low as 4.5V.

General Features

- $V_{DS} = 20V, I_D = 50A$
 $R_{DS(ON) Typ} = 4.5m\Omega @ V_{GS}=10V$
 $R_{DS(ON) Typ} = 5.0m\Omega @ V_{GS}=4.5V$
- High power and current handling capability
- Lead free product is acquired
- Surface mount package

Application

- Battery Switch
- Load switch
- Power management

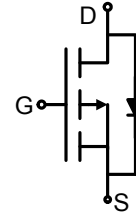

Schematic diagram

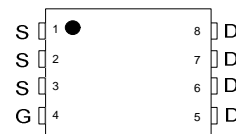

Pin assignment



PDFN3333-8 top view

Absolute Maximum Ratings ($T_A=25^\circ C$ unless otherwise noted)

Parameter		Symbol	Limit	Unit
Drain-Source Voltage		V_{DS}	20	V
Gate-Source Voltage		V_{GS}	± 12	V
Continuous Drain Current ($T_J=150^\circ C$)	$T_A = 25^\circ C$	I_D	50	A
	$T_A = 70^\circ C$		20	
Drain Current-Pulsed ^(Note 1)		I_{DM}	145	A
Maximum Power Dissipation		P_D	21	W
Operating Junction and Storage Temperature Range		T_J, T_{STG}	-55 To 150	$^\circ C$

Thermal Characteristic

Thermal Resistance, Junction-to-Ambient ^(Note 2)	$R_{\theta JA}$	2.1	$^\circ C/W$
---	-----------------	-----	--------------

Electrical Characteristics (T_C=25°C unless otherwise noted)

Parameter	Symbol	Condition	Min	Typ	Max	Unit
Off Characteristics						
Drain-Source Breakdown Voltage	BV _{DSS}	V _{GS} =0V, I _D =250μA	20	-	-	V
Zero Gate Voltage Drain Current	I _{DSS}	V _{DS} =20V, V _{GS} =0V	-	-	1	μA
Gate-Body Leakage Current	I _{GSS}	V _{GS} =±12V, V _{DS} =0V	-	-	±100	nA
On Characteristics (Note 3)						
Gate Threshold Voltage	V _{GS(th)}	V _{DS} =V _{GS} , I _D =250μA	0.5	0.75	1.0	V
Drain-Source On-State Resistance	R _{DS(on)}	V _{GS} =10V, I _D =15 A	-	4.5	6.5	mΩ
		V _{GS} =4.5V, I _D =10A		5.0	8.5	mΩ
Forward Transconductance	g _{FS}	V _{DS} =10V, I _D =15A	10	-	-	S
Dynamic Characteristics (Note 4)						
Input Capacitance	C _{iss}	V _{DS} =10V, V _{GS} =0V, F=1.0MHz	-	2000	-	PF
Output Capacitance	C _{oss}		-	500	-	PF
Reverse Transfer Capacitance	C _{rss}		-	200	-	PF
Switching Characteristics (Note 4)						
Turn-on Delay Time	t _{d(on)}	V _{DD} =10V, I _D =2A, R _L =1Ω V _{GS} =4.5V, R _G =3Ω	-	6.4	-	nS
Turn-on Rise Time	t _r		-	17.2	-	nS
Turn-Off Delay Time	t _{d(off)}		-	29.6	-	nS
Turn-Off Fall Time	t _f		-	16.8	-	nS
Total Gate Charge	Q _g	V _{DS} =10V, I _D =15A, V _{GS} =10V	-	27		nC
Gate-Source Charge	Q _{gs}		-	6.5		nC
Gate-Drain Charge	Q _{gd}		-	6.4		nC
Drain-Source Diode Characteristics						
Diode Forward Voltage (Note 3)	V _{SD}	V _{GS} =0V, I _S =15A	-		1.2	V
Diode Forward Current (Note 2)	I _S		-	-	50	A
Reverse Recovery Time	t _{rr}	T _J = 25°C, I _F = 15A	-	25	-	nS
Reverse Recovery Charge	Q _{rr}	di/dt = 100A/μs (Note 5)	-	24	-	nC
Forward Turn-On Time	t _{on}	Intrinsic turn-on time is negligible (turn-on is dominated by LS+LD)				

Notes:

1. Repetitive Rating: Pulse width limited by maximum junction temperature.
2. Surface Mounted on FR4 Board, t ≤ 10 sec.
3. Pulse Test: Pulse Width ≤ 300μs, Duty Cycle ≤ 2%.
4. Guaranteed by design, not subject to production
5. E_{AS} condition : T_J=25°C, V_{DD}=10V, V_G=10V, L=0.5mH, R_G=25Ω.

Test circuit

1) E_{AS} Test Circuit

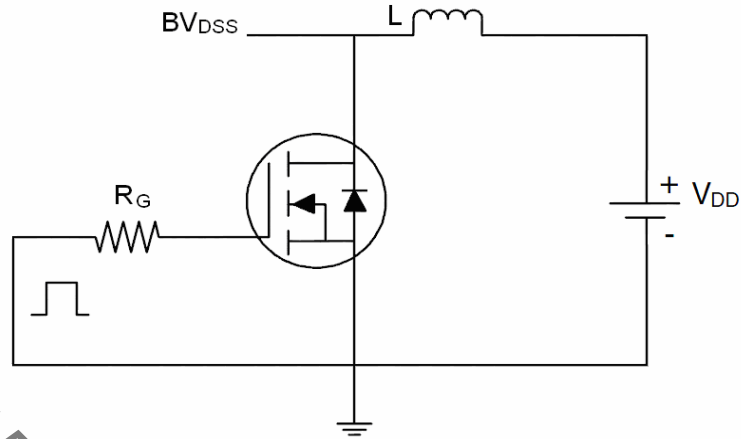

2) Gate Charge Test Circuit

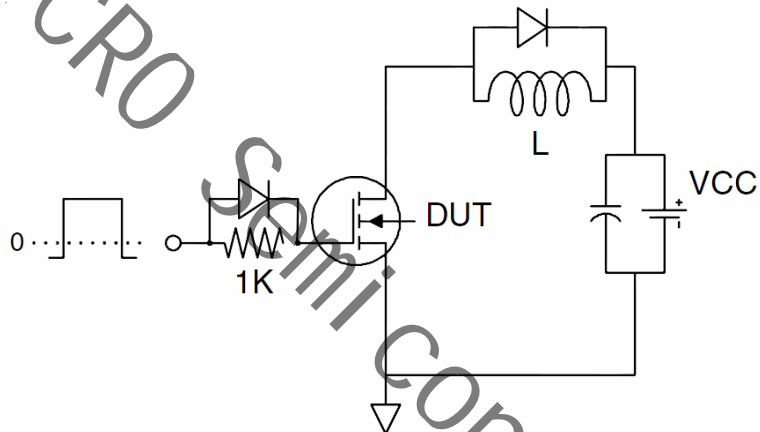

3) Switch Time Test Circuit

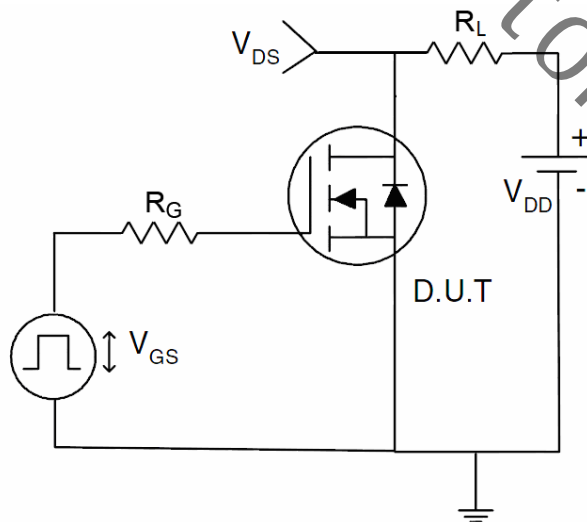

Typical Electrical and Thermal Characteristics (Curves)

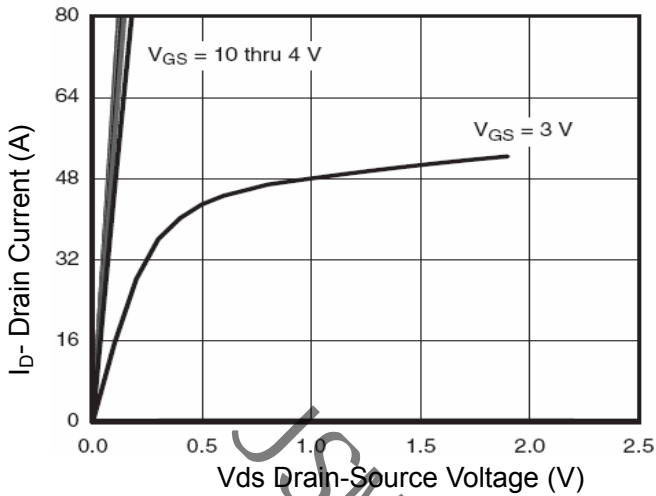

Figure 1 Output Characteristics

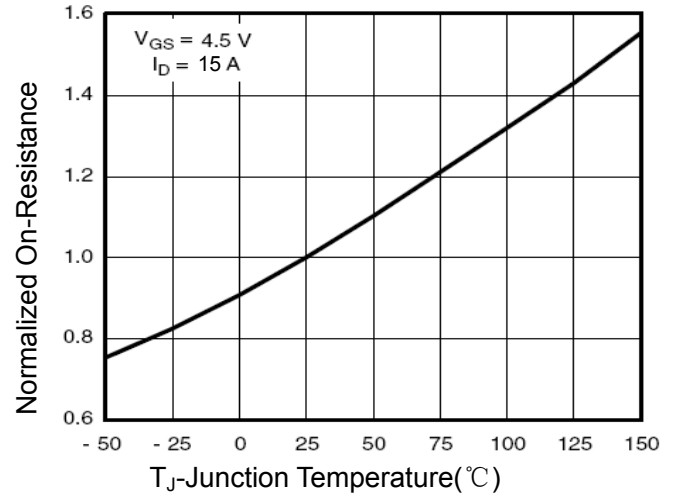

Figure 4 Rdson-Junction Temperature

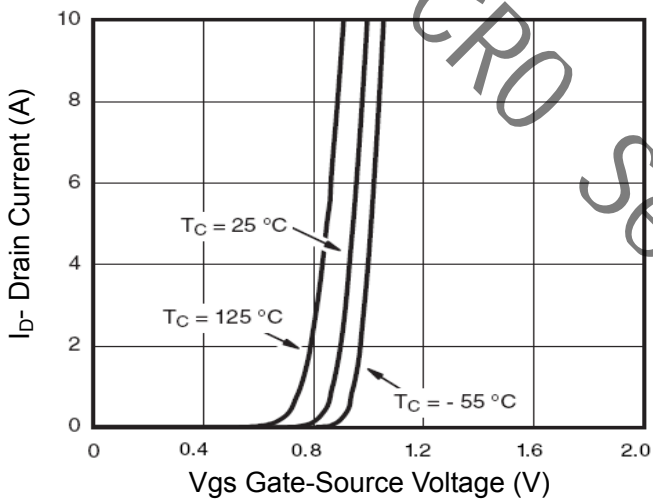

Figure 2 Transfer Characteristics

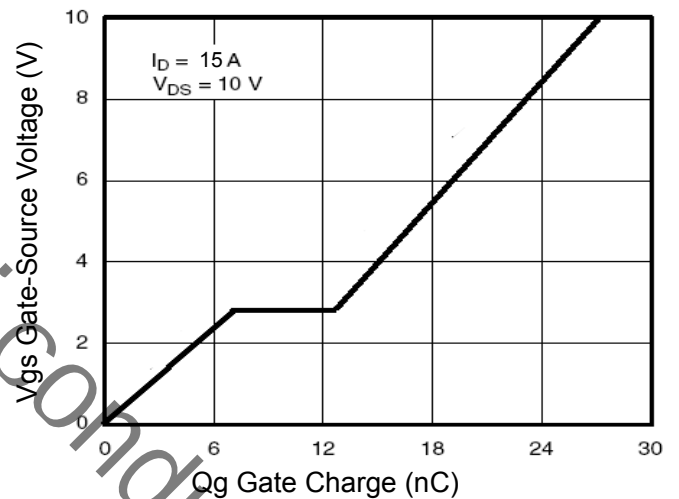

Figure 5 Gate Charge

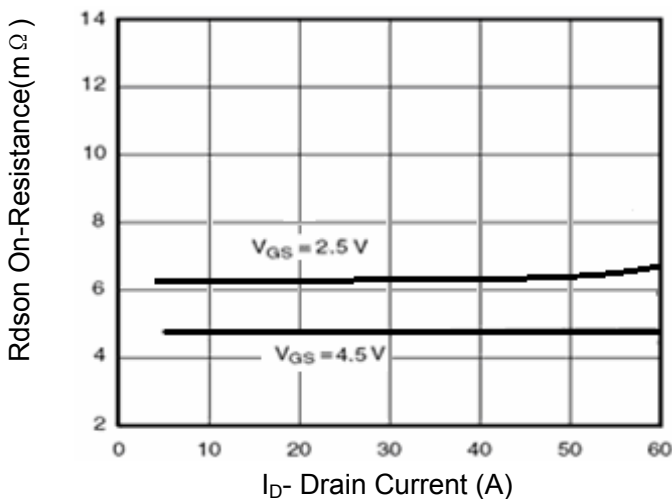

Figure 3 Rdson- Drain Current

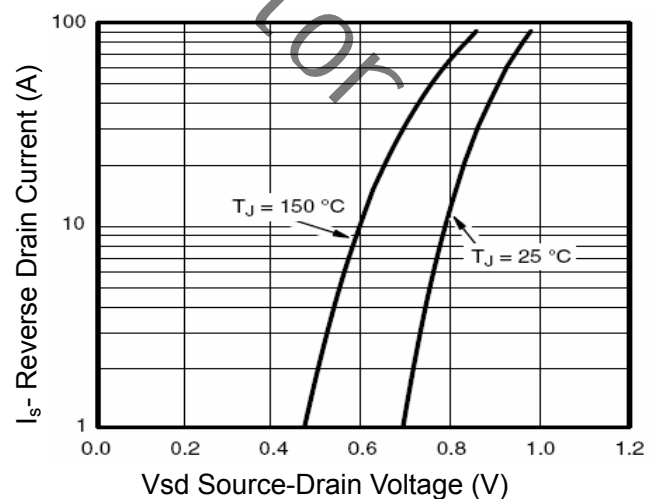

Figure 6 Source- Drain Diode Forward

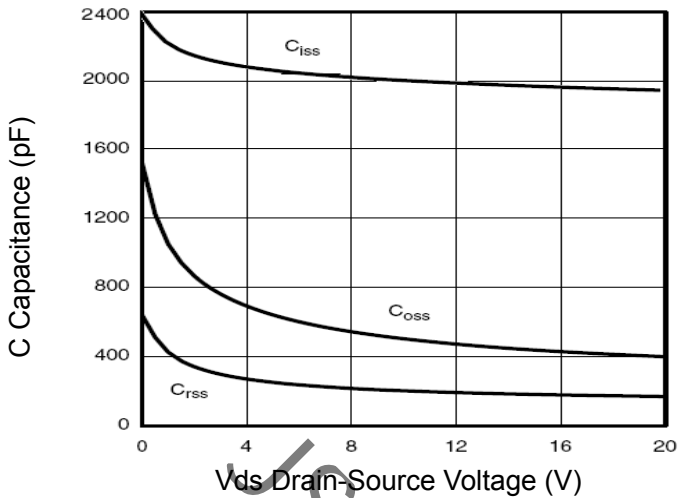

Figure 7 Capacitance vs Vds

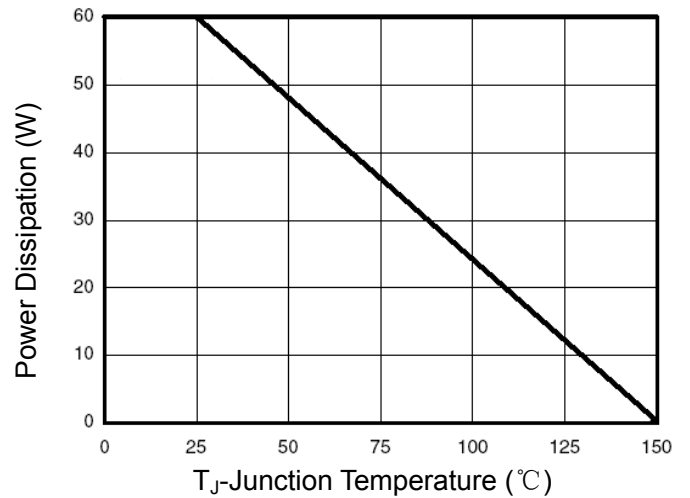

Figure 9 Power De-rating

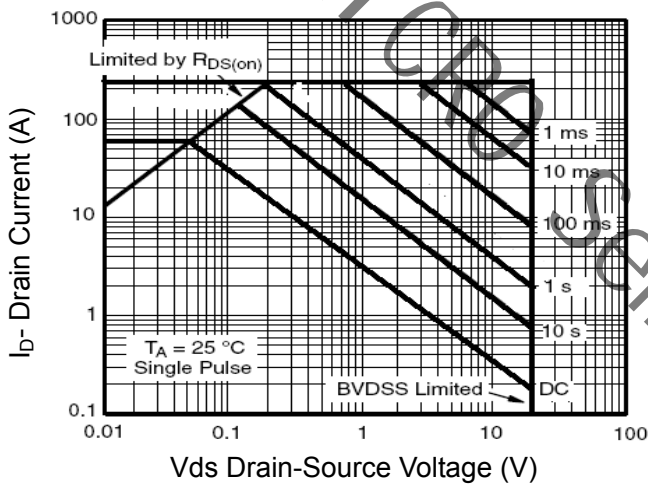

Figure 8 Safe Operation Area

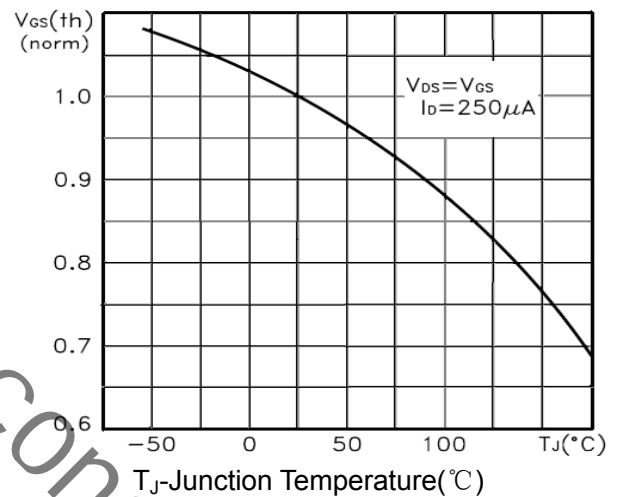

Figure 10 $V_{GS(th)}$ vs Junction Temperature

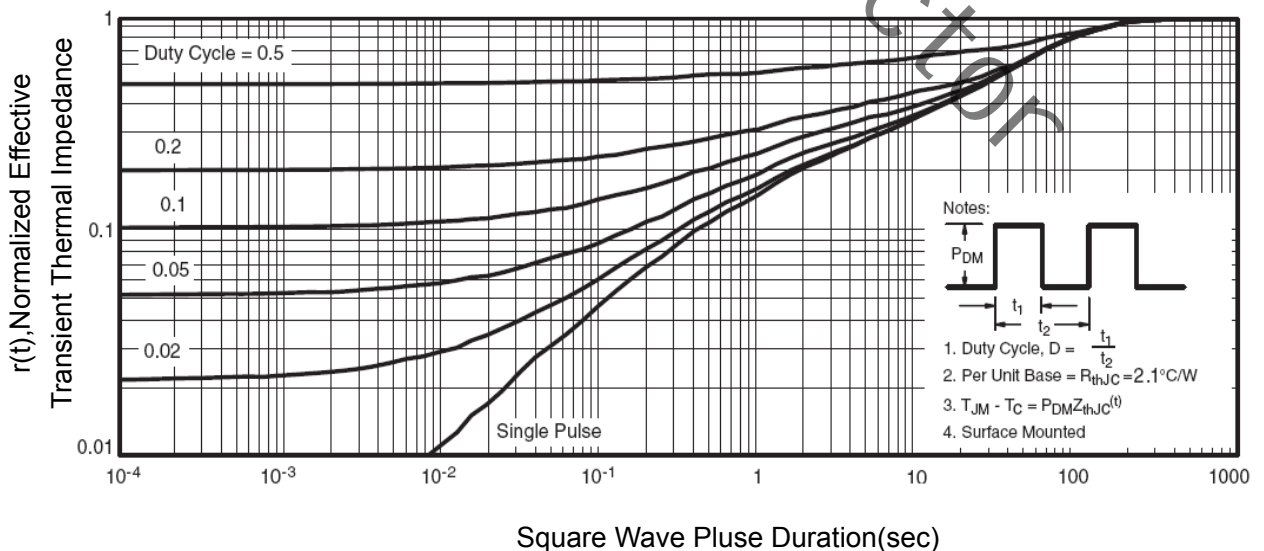
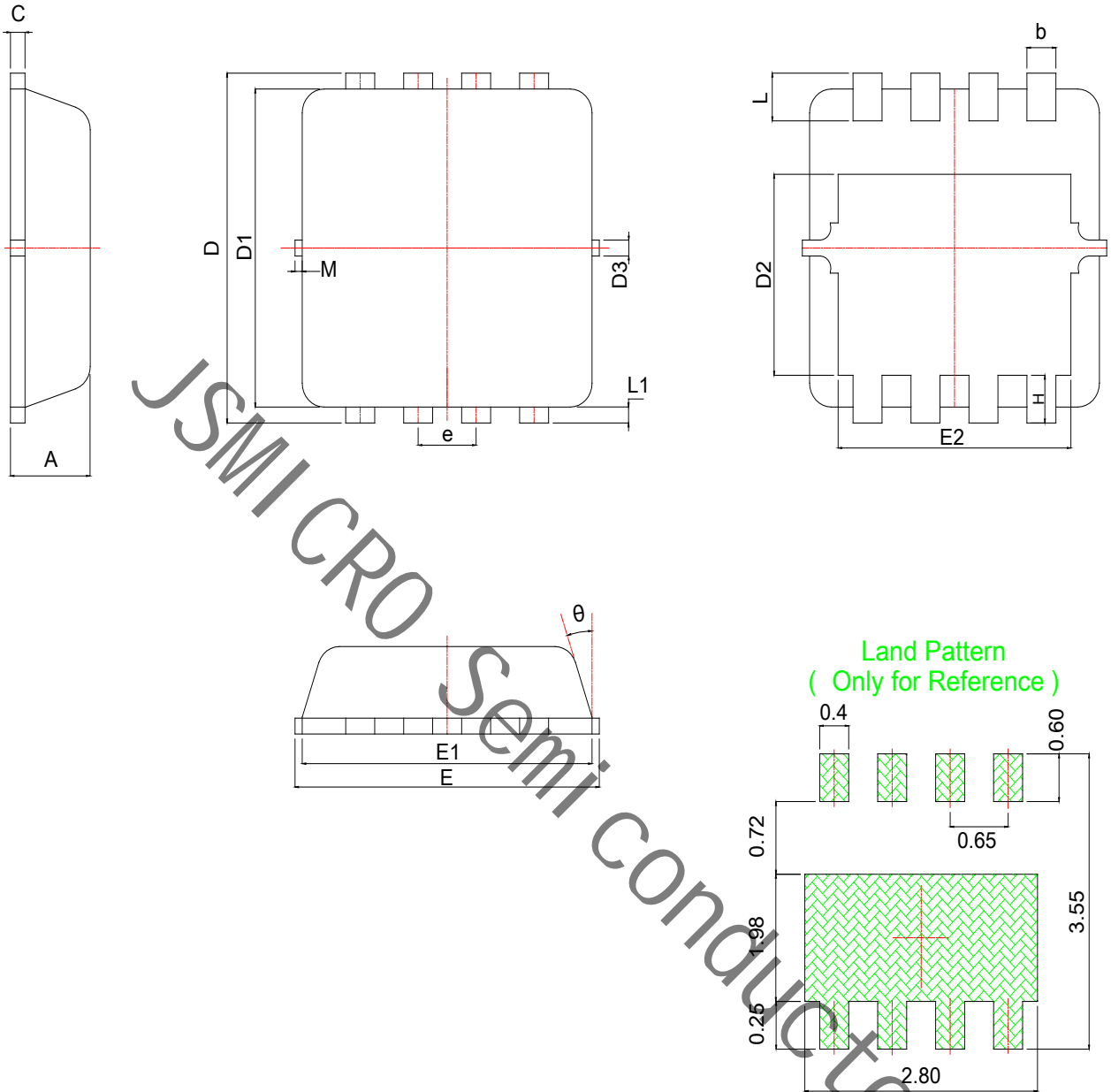

Figure 11 Normalized Maximum Transient Thermal Impedance

Package Information
PDFN3333

SYMBOL	MM			INCH			SYMBOL	MM			INCH		
	MIN	NOM	MAX	MIN	NOM	MAX		MIN	NOM	MAX	MIN	NOM	MAX
A	0.70	0.75	0.80	0.028	0.030	0.031	E1	3.00	3.15	3.20	0.118	0.122	0.126
b	0.25	0.30	0.35	0.010	0.012	0.014	E2	2.39	2.49	2.59	0.094	0.098	0.102
c	0.10	0.15	0.25	0.004	0.007	0.010	e	0.65BSC			0.026BSC		
D	3.25	3.35	3.45	0.128	0.132	0.136	H	0.30	0.40	0.50	0.012	0.016	0.020
D1	3.00	3.10	3.20	0.118	0.122	0.126	L	0.30	0.40	0.50	0.012	0.016	0.020
D2	1.78	1.88	1.98	0.070	0.074	0.078	L1	*	0.13	*	*	0.005	*
D3	*	0.13	*	*	0.005	*	θ	*	10°	12°	*	10°	12°
E	3.20	3.30	3.40	0.126	0.130	0.134	M	*	*	0.15	*	*	0.006